

Modelmaker by theboxbuilder **Catalogue**

(Version 1.7 EN)

Index

1. Introduction	2
2. Codification	3
3. Families	4
4. Gluing systems	4
5. Materials	5
6. Contact details	6
7. Catalogue of designs	7

1. Introduction

Modelmaker is an application for structural packaging design. The most important feature of the system is that it is used online. It is the only such program on the market.

In addition to that special feature, Modelmaker stands out as it possesses the highest quality standard designs on the market.

All of the designs in our catalogue are created by highly experienced designers so as to ensure that all of the requirements of the productive process are met.

The catalogue acts as a support document for the application in which you can search for the design you need.

NOTE: Modelmaker is a continually evolving application. The Design Department always works to add new designs to the library. Due to the above, the Catalogue can rapidly become obsolete. In order to view all of the updated designs you have to log on to our system at www.theboxbuilder.com.

One of the real advantages of Modelmaker is the constant evolution of the application's content.

Our Design Department takes charge of continually increasing the number of designs in the library, thus providing our clients with a more comprehensive library on a daily basis.

Our clients' suggestions are essential to this process of continual improvement. If you think that a standard design in the library could be improved or if you have any suggestions regarding boxes you would like to see in the application, let us know by sending an e-mail to:

design@theboxbuilder.com

As well as informing us of your requirements, you can attach an image in any format you wish (jpg, bmp, eps, dxf, pdf...) to let us know what you wish.

The Box Builder's design department will respond to your suggestions as quickly as possible.

Thank you.

2. Codification

All of the designs in Modelmaker's library are codified so that you can search through and use the contents quickly and efficiently.

Three different types of codification are used, namely:

- **"The Box Builder"** codification

This codification is based on The Box Builder's Design Department's criteria.

We differentiate between two broad groups for this codification, namely:

- **LT Designs**
- **OT Designs**

The designs codified as "LT" are programmed for fine materials, both cartonboard and plastic, and the design details are developed especially for these materials.

The designs codified as "OT" are programmed for thick materials, for general use with corrugated board, and the design details are developed especially for these materials.

- **"FEFCO"** codification

FEFCO is the "European Federation of Corrugated Board Manufacturers," which provides an established international codification for corrugated board.

For more information, www.fefco.org

- **"ECMA"** codification

ECMA is the "European Carton Makers Association," which provides international codification for folding carton.

For more information, www.ecma.org

NOTE: Not all of The Box Builder's designs match a code in the FEFCO or ECMA catalogues, which is why some designs in the library are catalogued solely under The Box Builder's codification.

3. Families

To facilitate your search for the required design, the contents of Modelmaker's library are divided into groups.

These groups are based on The Box Builder's Design Department's criteria and are related to the use and/or productive process for each design.

The groups are:

- **Tuck end**
- **Semi-auto Lock**
- **Crash Lock Bottom**
- **Sleeves**
- **Glued Trays**
- **Self-Locking Trays**
- **Blisters / Cluster Pack**
- **Folders**
- **Click Clock**
- **Overlap Seal ends**
- **Envelopes / Bags**
- **Dispensers / Displays**
- **Promotions / Gifts**
- **Interiors / Dividers**
- **Specials**

4. Gluing systems

To facilitate your search for the required design, Modelmaker has a series of filters that you can use.

One of these filters is the design's "Gluing System".

This filter means that you can choose to view only the designs that interest you based on their gluing systems, namely:

- **Straight Line**
- **4 Corner**
- **6 Corner**
- **Crash Lock Bottom**
- **Packers**
- **Hand Glued**
- **Glue Free**

5. Materials

All of Modelmaker's designs are created for specific materials. Modifications are calculated automatically in accordance with the material selected. During the design process, it is possible to change the material selected as often as you wish. The system shall rebuild the design depending on the requirements of your new selection. There is a specific filter for materials so that you can search for the design you require for a particular material. The materials are:

CODE	SOLID/COMPACT	CORRUGATED	THICKNESS (m/m)
X	Y		Up to 0.8
XX	Y		From 0.8 to 2
N		Y	1.1
F		Y	1.2
E		Y	1.5
B		Y	3
C		Y	4
A		Y	5
BB		Y	6
BC		Y	7
BA		Y	8
AC		Y	9
AA		Y	10
BAC		Y	12
BAA		Y	13
ACA		Y	14
AAA		Y	15

NOTE: As the correlation between "Code" and "Thickness" does not always match that of the cartonboard manufactured on the market, Modelmaker recommends using the figure for material thickness when creating a design.

All of Modelmaker's designs are created for specific materials. The color of the design in the library tells us the type of cartonboard for which each standard design is programmed. These are:

- **Light Gray:** Designs for folding carton and corrugated board up to a thickness of 1.6mm.
- **Brown:** Designs for corrugated board of a thickness of 3mm and greater.
- **Blue:** Designs for fine plastic
- **Dark gray:** Designs for thick folding carton (over 0.8mm).

6. Contact details

If you have any suggestions regarding this Catalogue or Modelmaker application, contact us at:

www.web-info@theboxbuilder.com

For any operational problems in the application, send an email to:

www.web-support@theboxbuilder.com

If you have any suggestions regarding Modelmaker application's range of designs, send an email to:

www.design@theboxbuilder.com

Thank you.

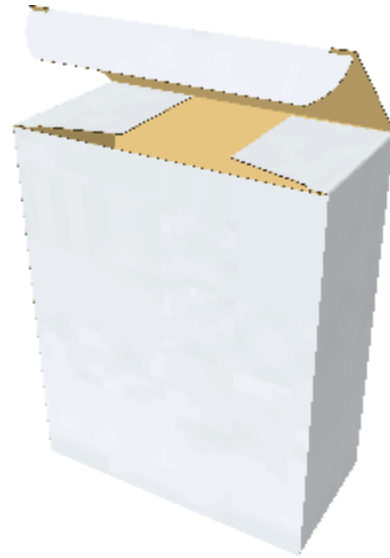
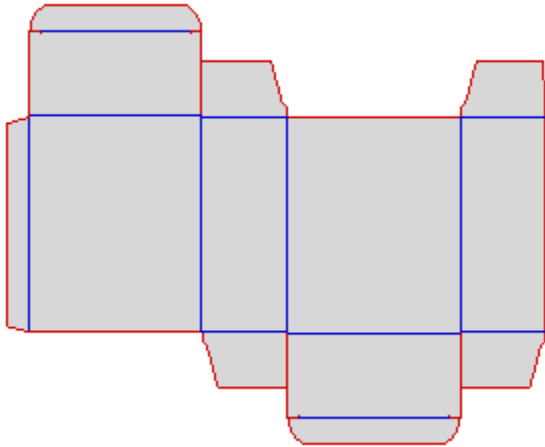

Tuck end

LT010101

Straight line

Compact & E flute

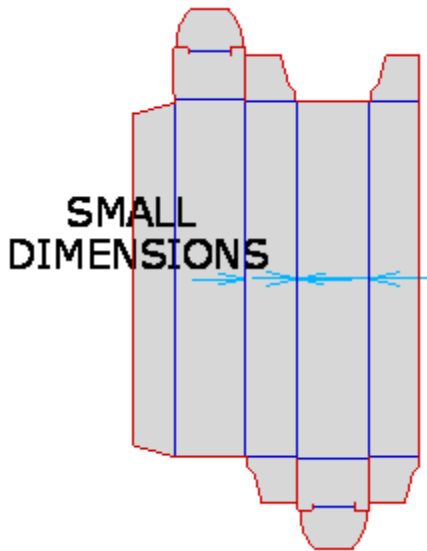

Tuck end

LT010102

Straight line

Compact & E flute

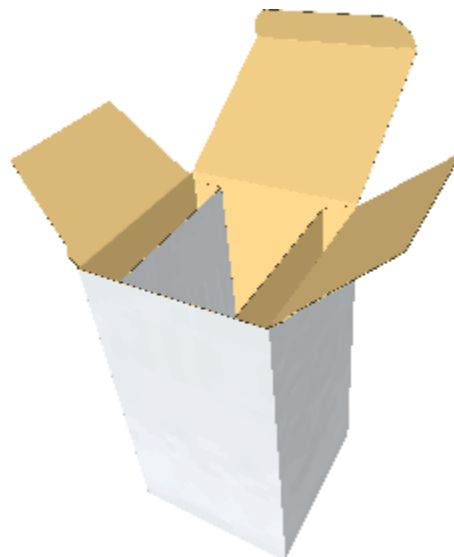
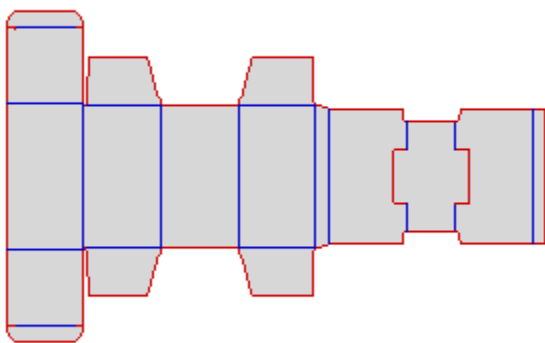

Tuck end

LT012105

Straight line

Compact & E flute

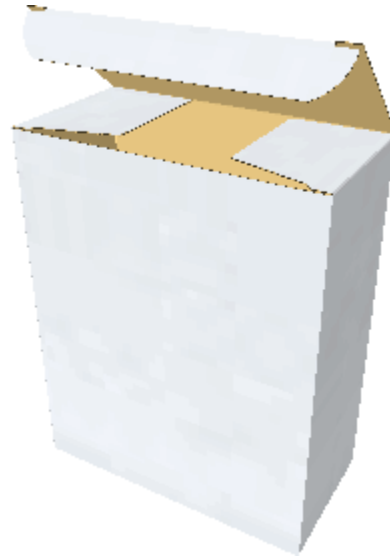
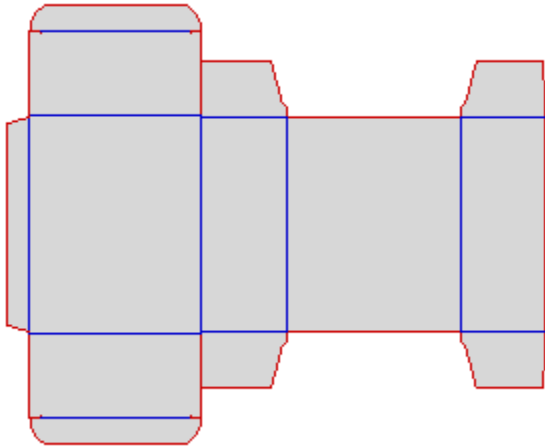

Tuck end

LT010105

Straight line

Compact & E flute

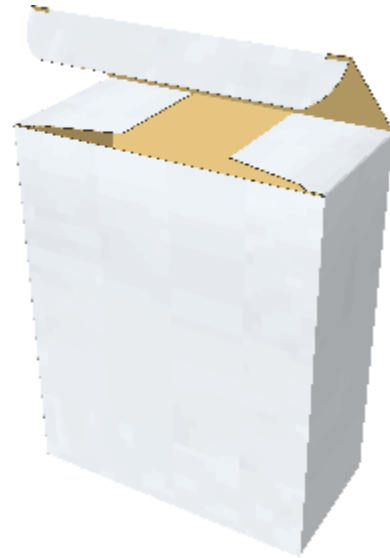
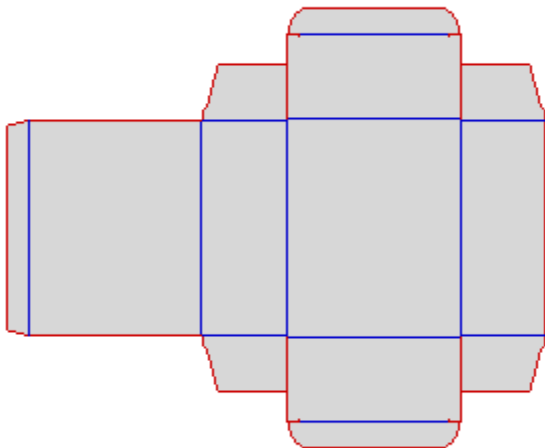

Tuck end

LT010108

Straight line

Compact & E flute

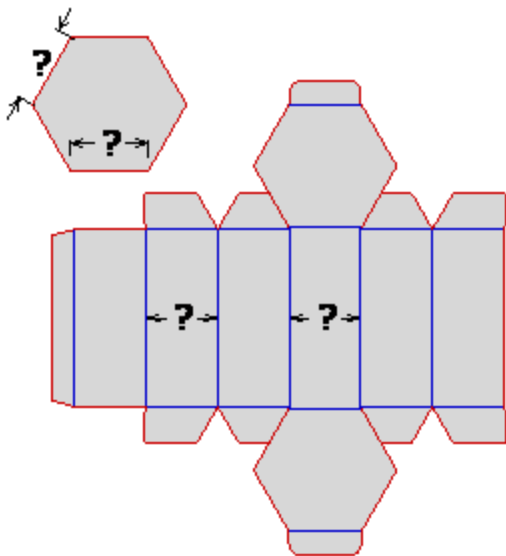







Tuck end

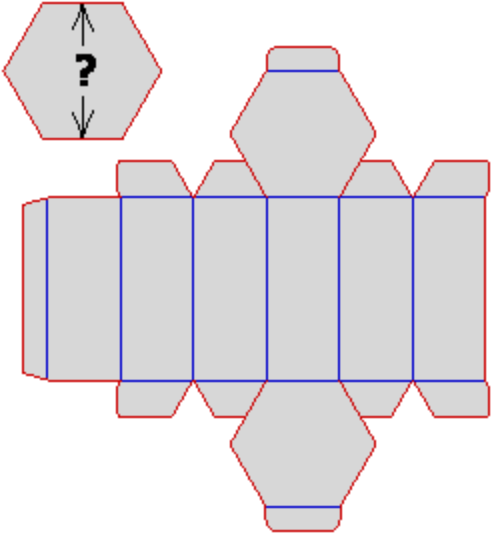
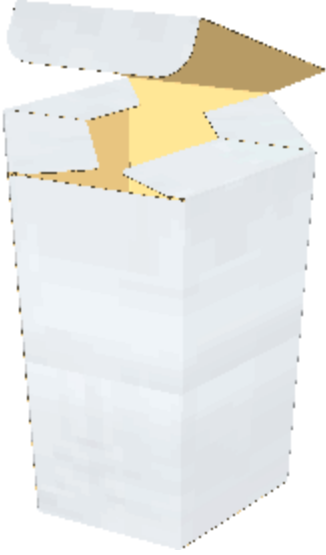
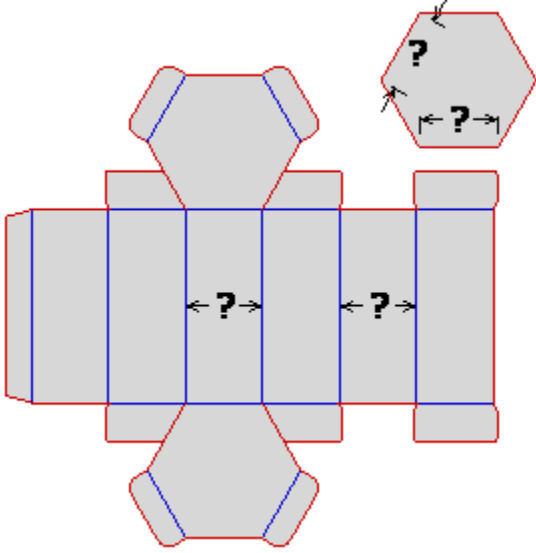

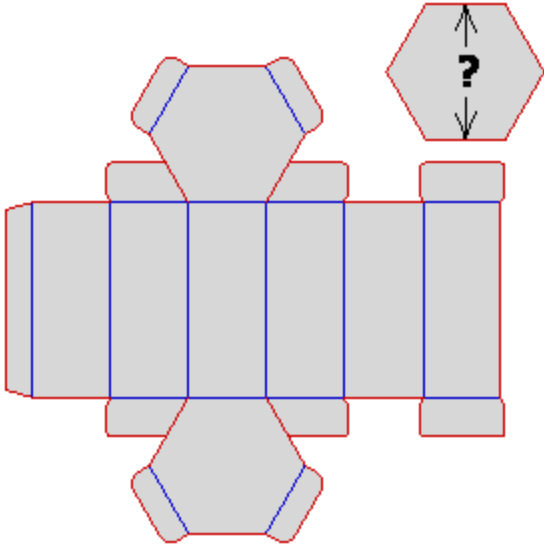
LT010125

Straight line

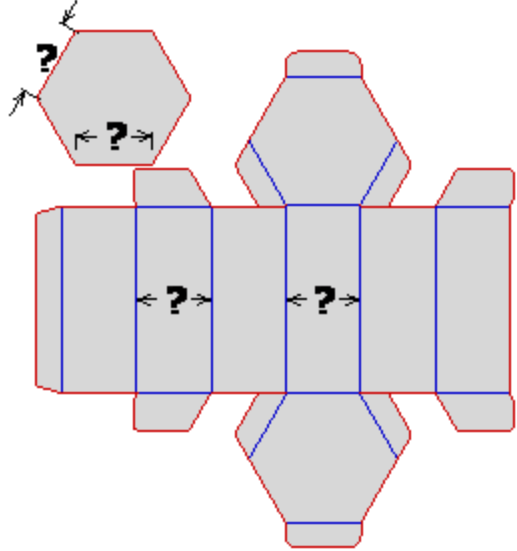
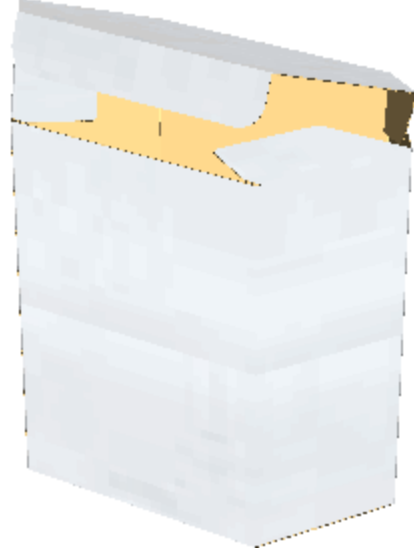
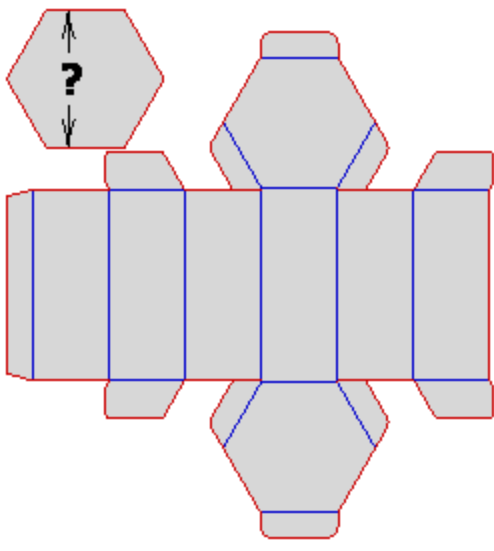

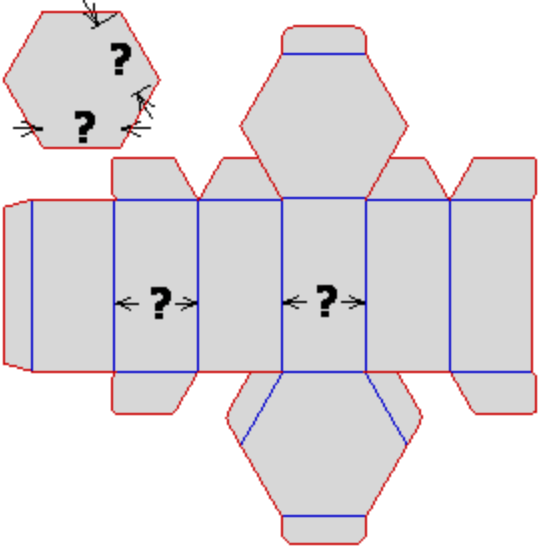
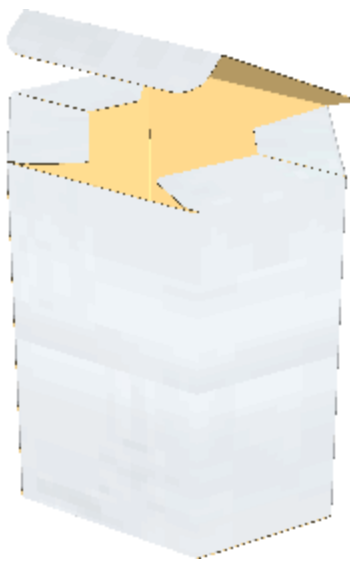

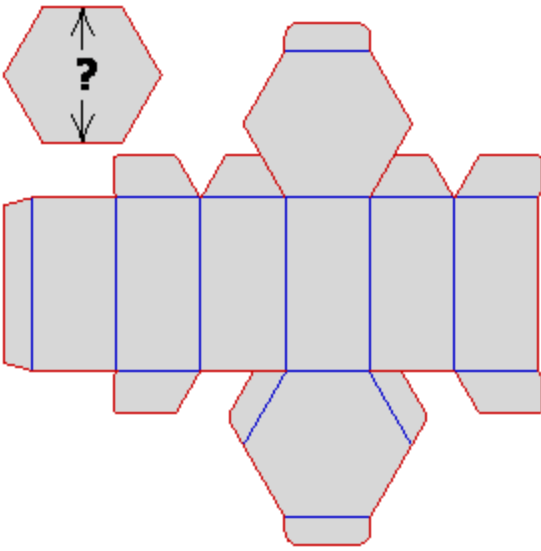
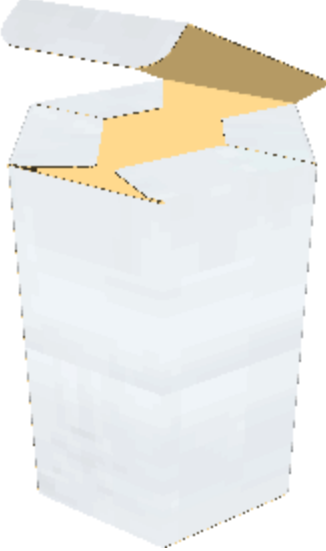
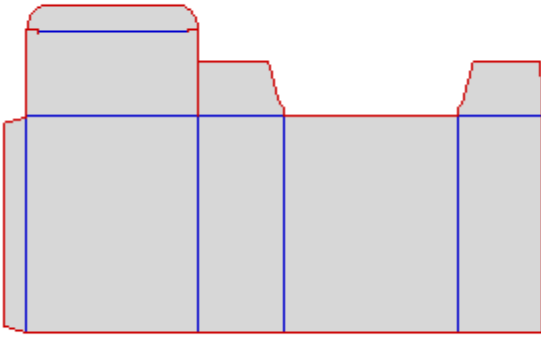
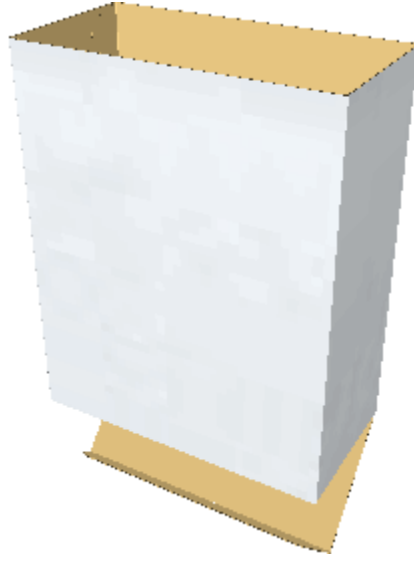
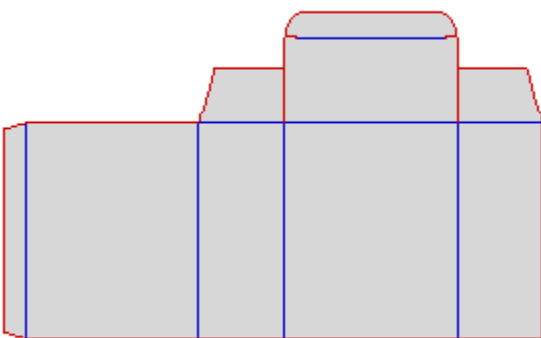
Compact & E flute

		Tuck end
<p>LT010126</p>	<p>Straight line</p>	<p>Compact & E flute</p>
		Tuck end
<p>LT010127</p>	<p>Straight line</p>	<p>Compact & E flute</p>
		Tuck end
<p>LT010128</p>	<p>Straight line</p>	<p>Compact & E flute</p>

		Tuck end	
<p>LT010129</p>	<p>Straight line</p>		<p>Compact & E flute</p>
			Tuck end
<p>LT010130</p>	<p>Straight line</p>	<p>Compact & E flute</p>	
		Tuck end	
<p>LT010131</p>	<p>Straight line</p>		<p>Compact & E flute</p>

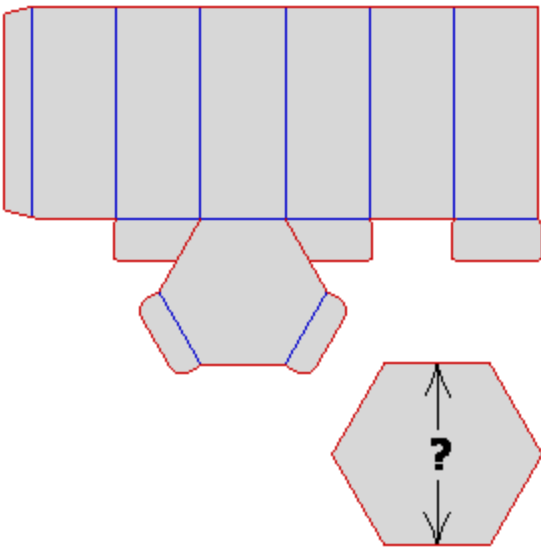
		Tuck end
<p>LT010132</p>	<p>Straight line</p>	<p>Compact & E flute</p>
		Tuck end
<p>LT010001</p>	<p>Straight line</p>	<p>Compact & E flute</p>
		Tuck end
<p>LT010002</p>	<p>Straight line</p>	<p>Compact & E flute</p>

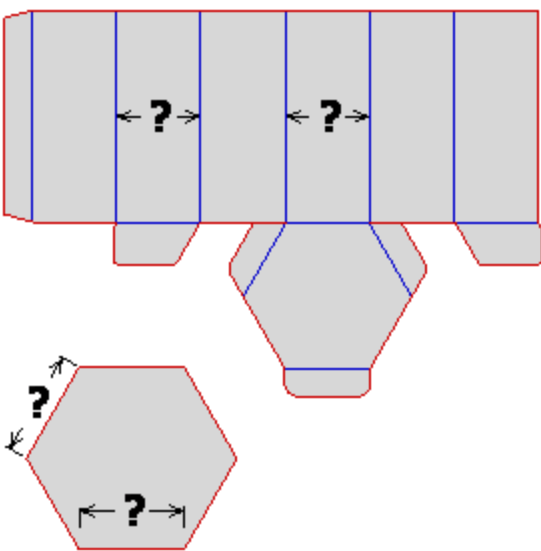
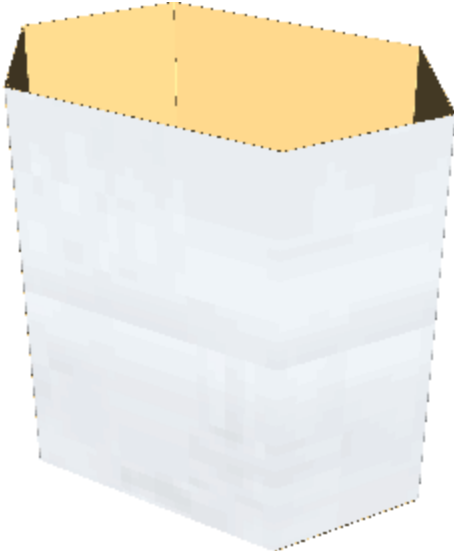
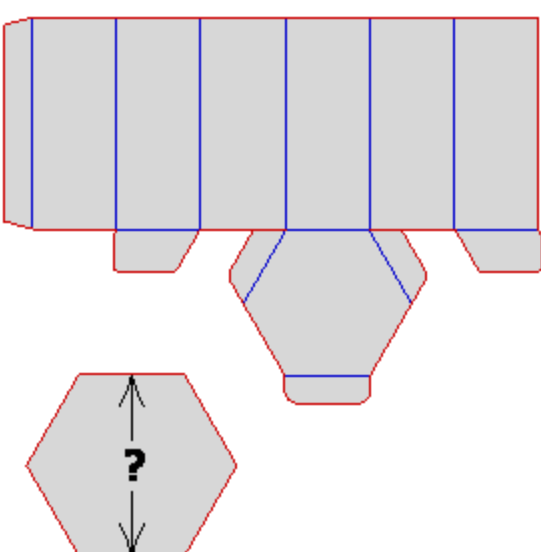
			Tuck end
<p>LT010020</p>	<p>Straight line</p>	<p>Compact & E flute</p>	
			Tuck end
<p>LT010021</p>	<p>Straight line</p>	<p>Compact & E flute</p>	
			Tuck end
<p>LT010022</p>	<p>Straight line</p>	<p>Compact & E flute</p>	

		Tuck end	
<p>LT010023</p>	<p>Straight line</p>		<p>Compact & E flute</p>
			Tuck end
<p>LT010024</p>	<p>Straight line</p>	<p>Compact & E flute</p>	
		Tuck end	
<p>LT010025</p>	<p>Straight line</p>		<p>Compact & E flute</p>

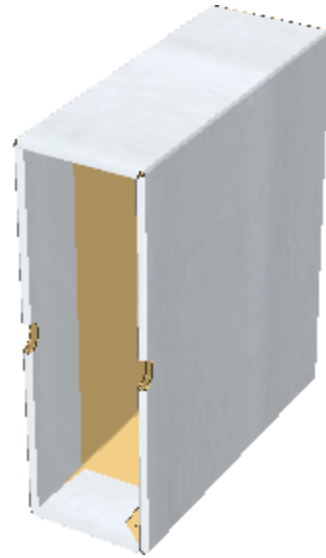
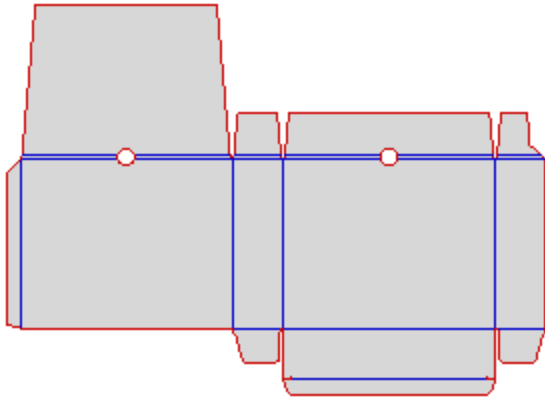

Tuck end

LT010003

Straight line

Compact & E flute

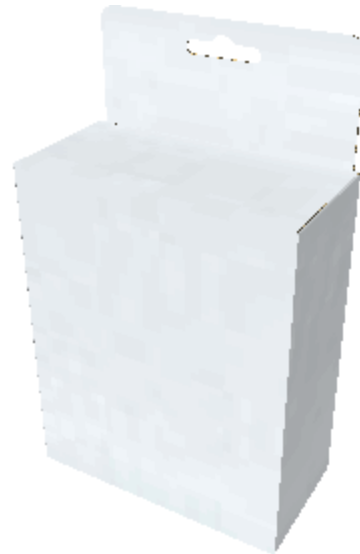
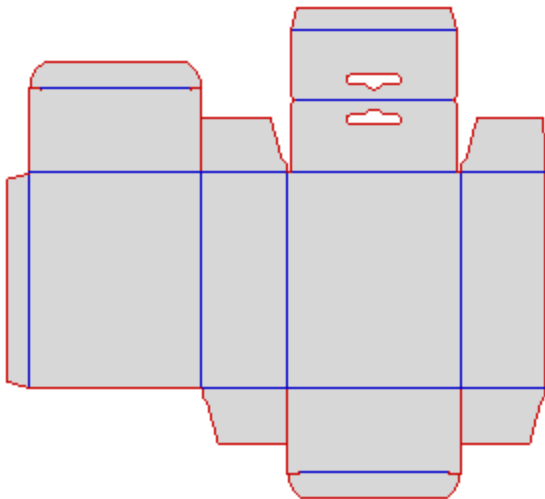

Tuck end

LT010201

Straight line

Compact & E flute

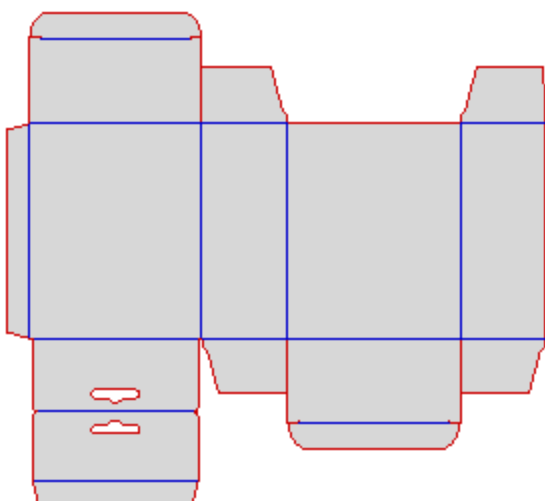

Tuck end

LT010202

Straight line

Compact & E flute

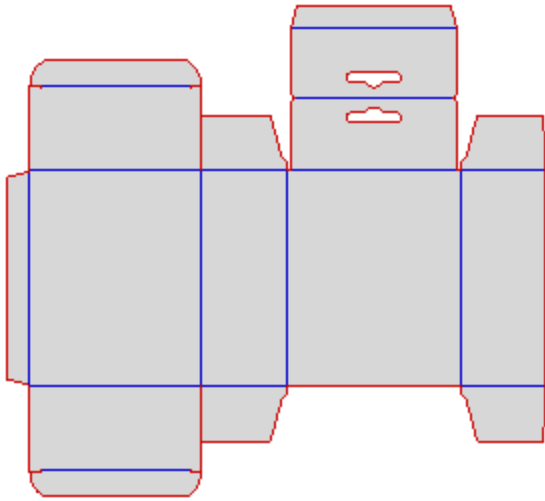

Tuck end

LT010203

Straight line

Compact & E flute

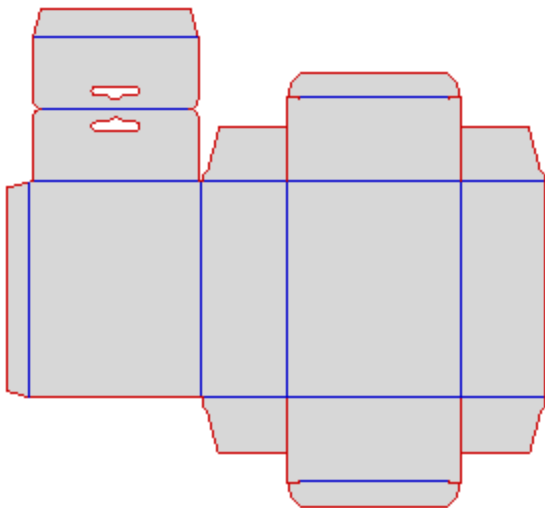

Tuck end

LT010205

Straight line

Compact & E flute

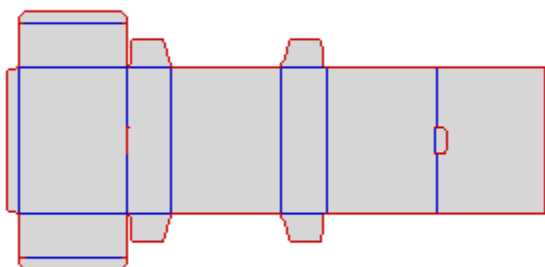

Tuck end

LT010301

Straight line

Compact & E flute

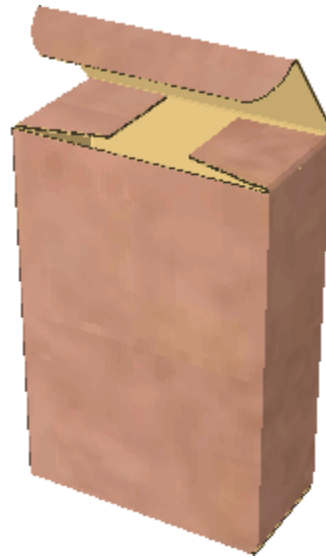
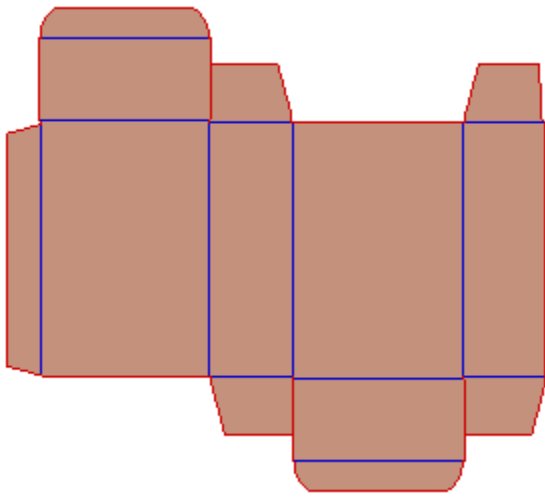

Tuck end

OT010104

Straight line

Corrugated

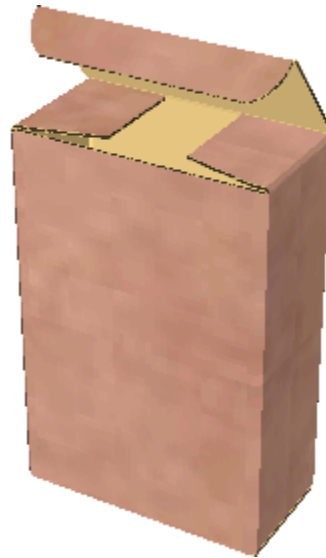
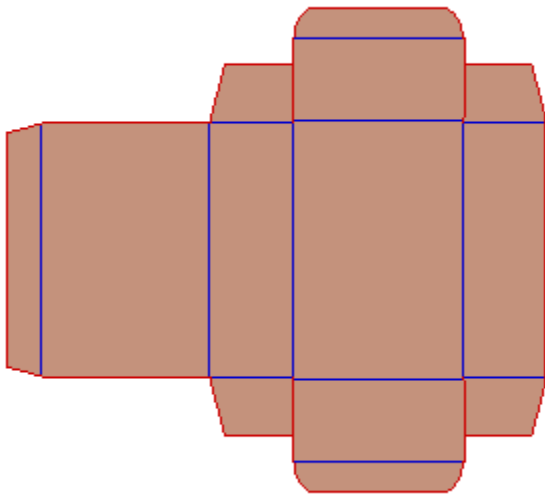

Tuck end

OT010110

Straight line

Corrugated

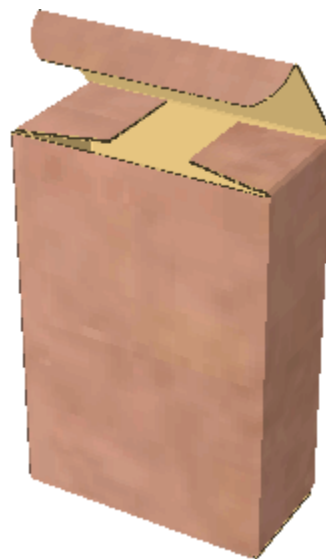
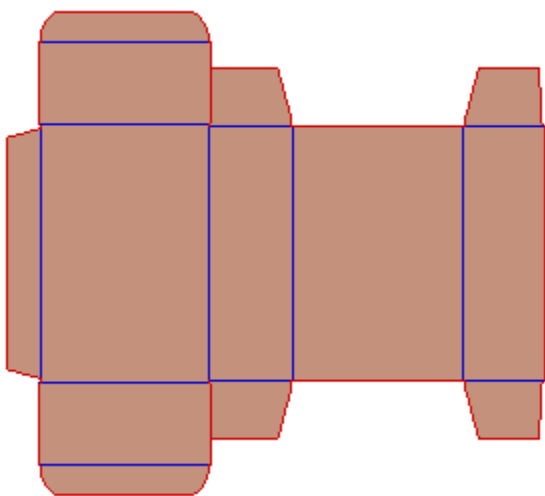

Tuck end

OT010107

Straight line

Corrugated

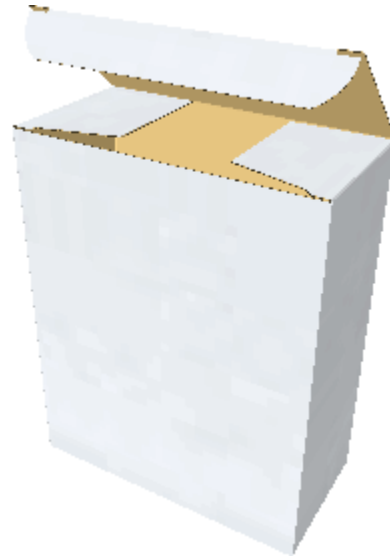
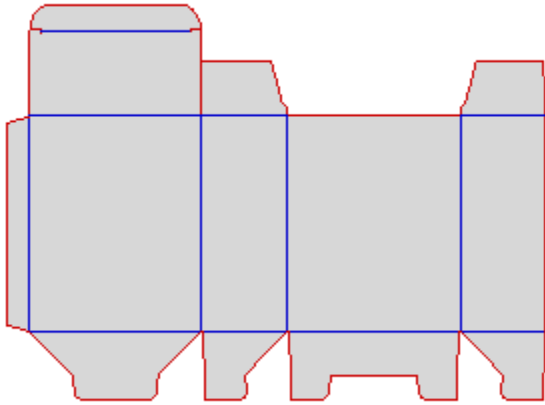

Semi-Auto Lock

LT020100

Straight line

Compact & E flute

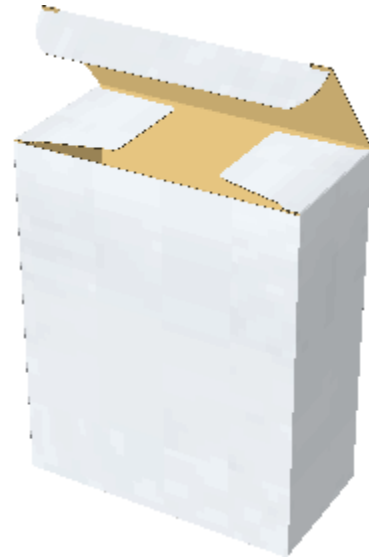
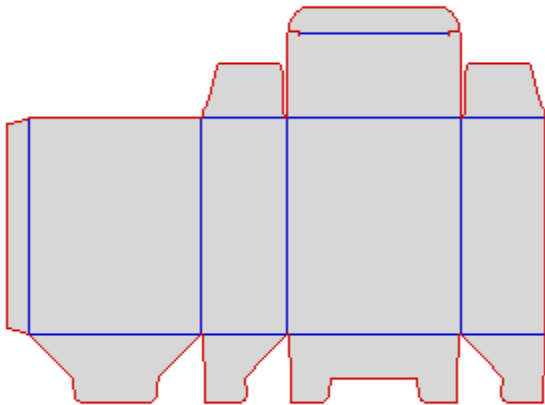

Semi-Auto Lock

LT020102

Straight line

Compact & E flute

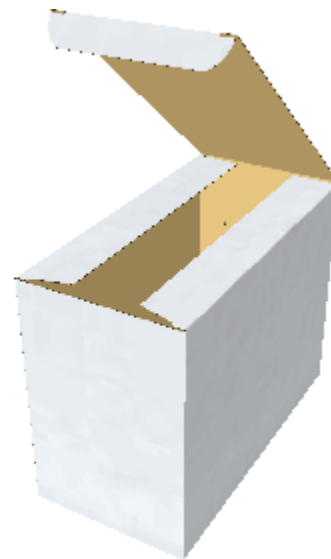
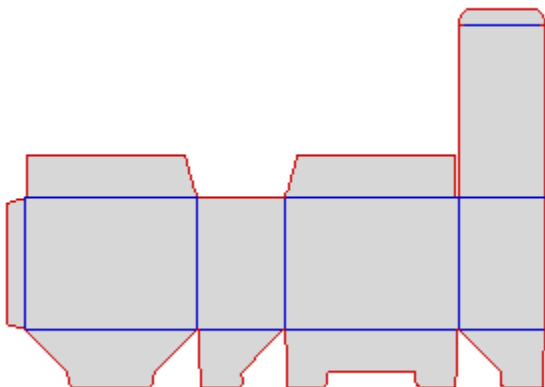





Semi-Auto Lock

LT020101

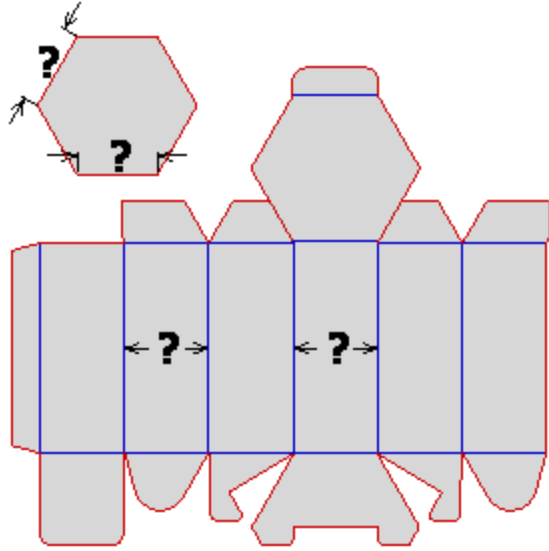
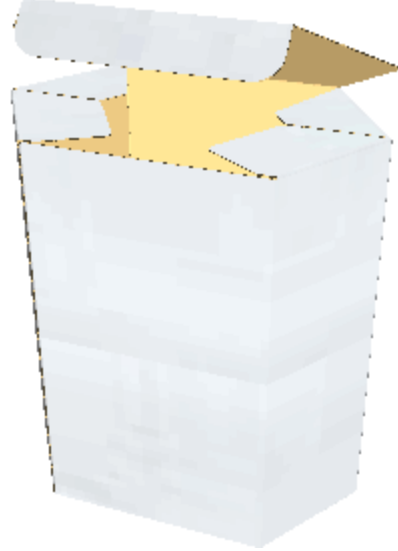
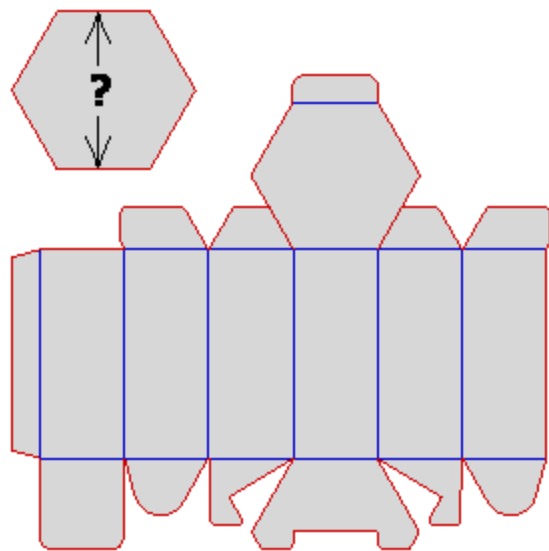
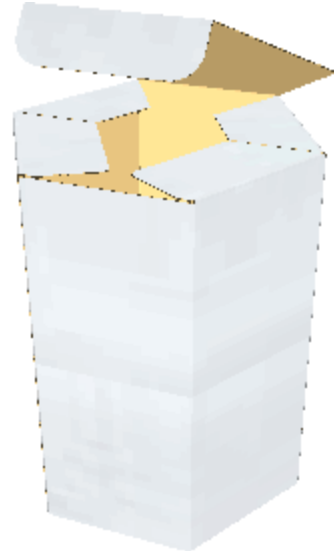
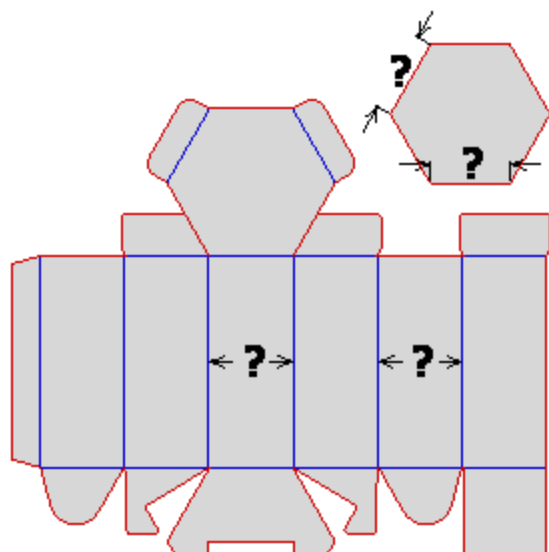
Straight line

Compact & E flute

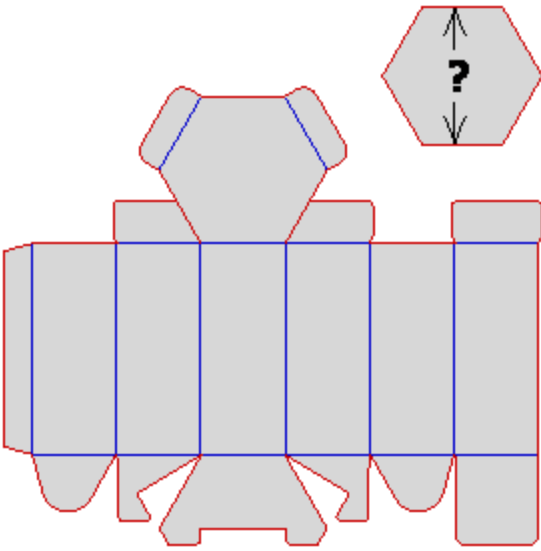
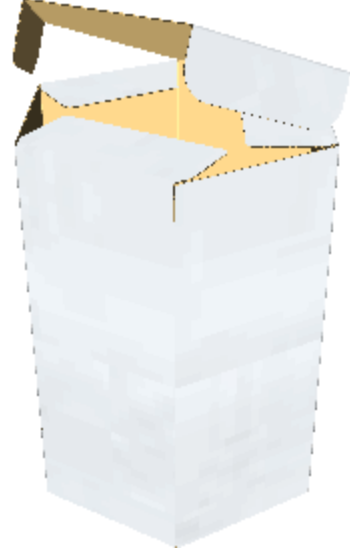
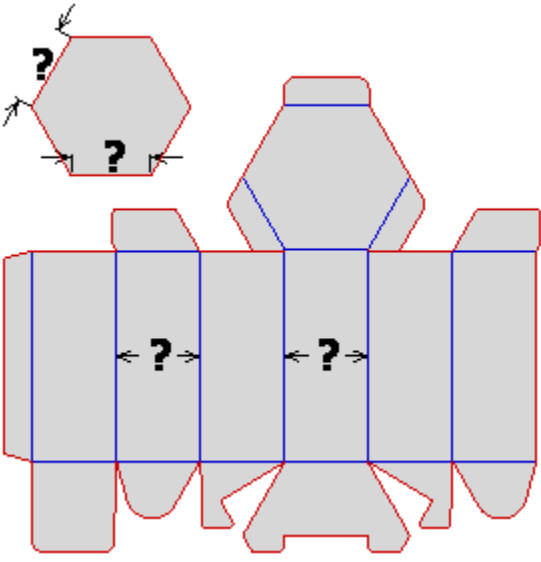
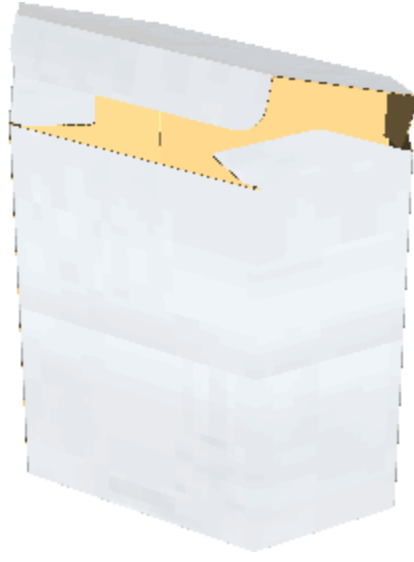
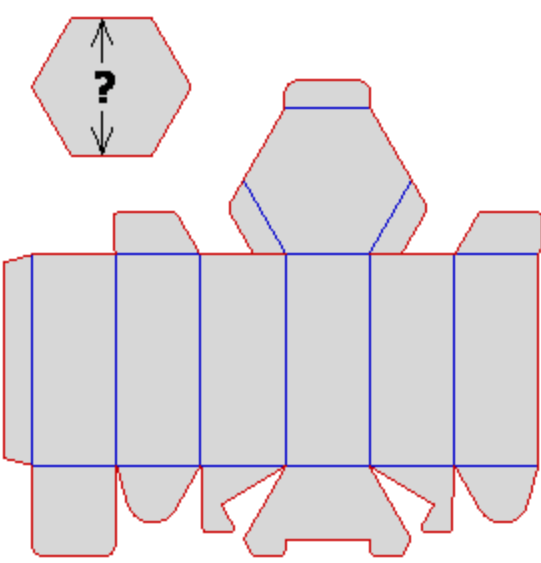
		Semi-Auto Lock	
LT020125	Straight line		Compact & E flute
			Semi-Auto Lock
LT020126	Straight line	Compact & E flute	
		Semi-Auto Lock	
LT020127	Straight line		Compact & E flute

		<p style="writing-mode: vertical-rl; transform: rotate(180deg);">Semi-Auto Lock</p>	
<p>LT020128</p>	<p>Straight line</p>		<p>Compact & E flute</p>
			<p style="writing-mode: vertical-rl; transform: rotate(180deg);">Semi-Auto Lock</p>
<p>LT020129</p>	<p>Straight line</p>	<p>Compact & E flute</p>	
		<p style="writing-mode: vertical-rl; transform: rotate(180deg);">Semi-Auto Lock</p>	
<p>LT020130</p>	<p>Straight line</p>		<p>Compact & E flute</p>

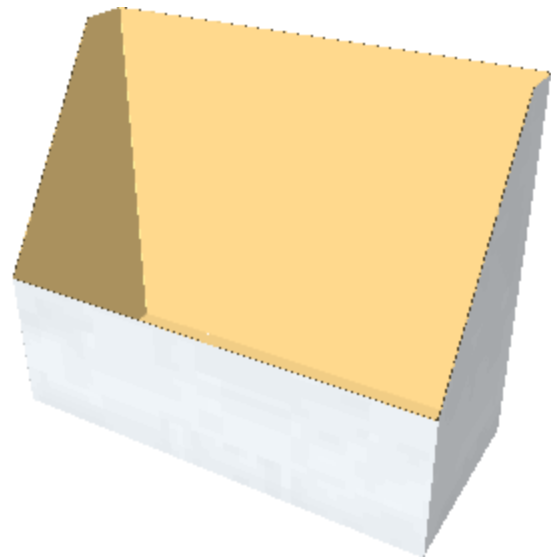
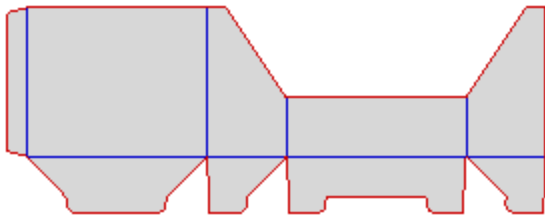

Semi-Auto Lock

LT020002

Straight line

Compact & E flute

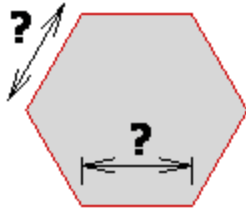
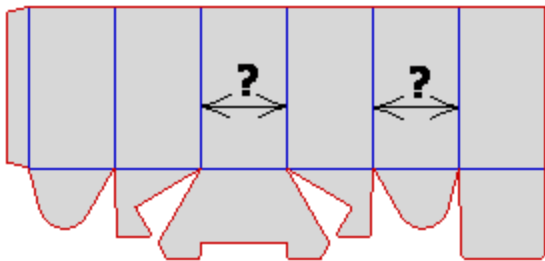

Semi-Auto Lock

LT020003

Straight line

Compact & E flute

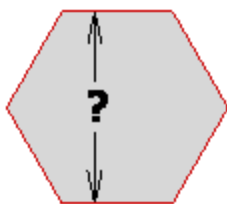
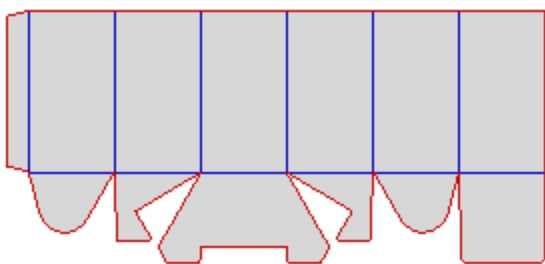

Semi-Auto Lock

LT020004

Straight line

Compact & E flute

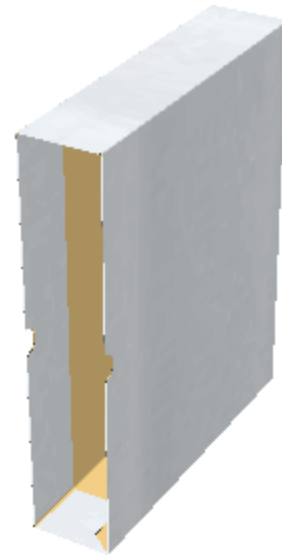
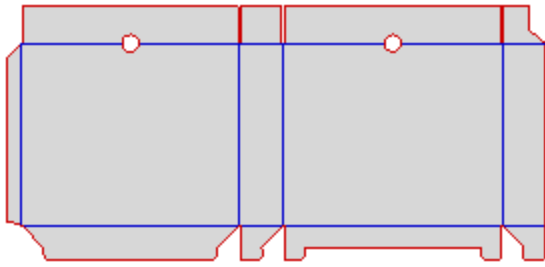

Semi-Auto Lock

LT020001

Straight line

Compact & E flute

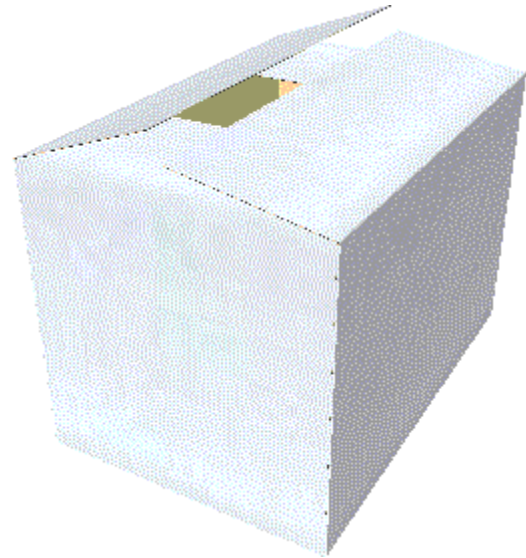
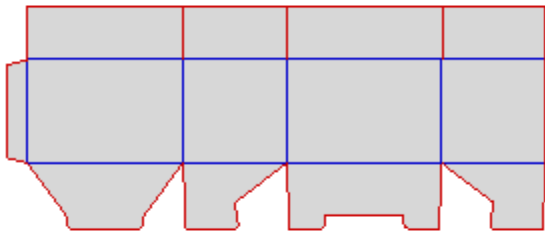

Semi-Auto Lock

LT023001

Straight line

Compact & E flute

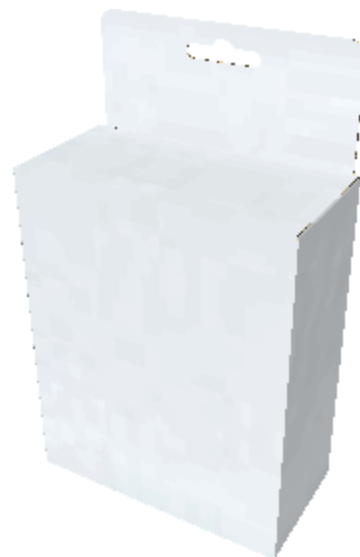
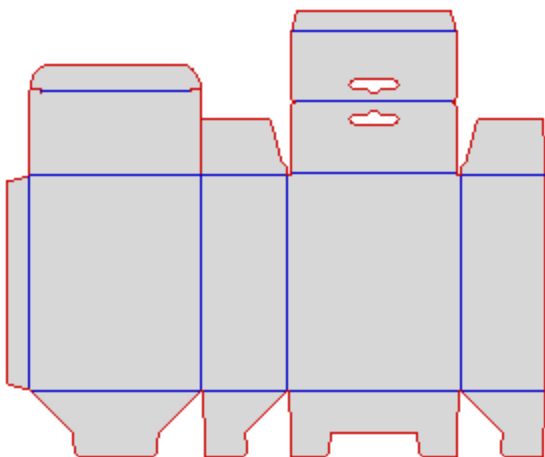

Semi-Auto Lock

LT020200

Straight line

Compact & E flute

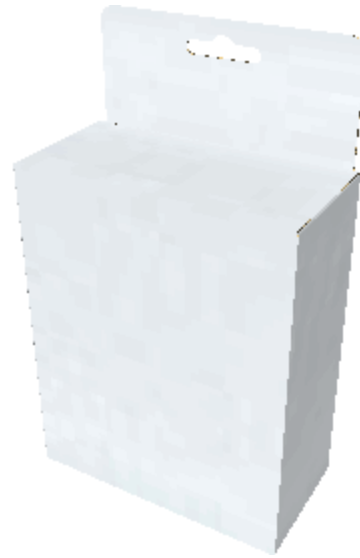
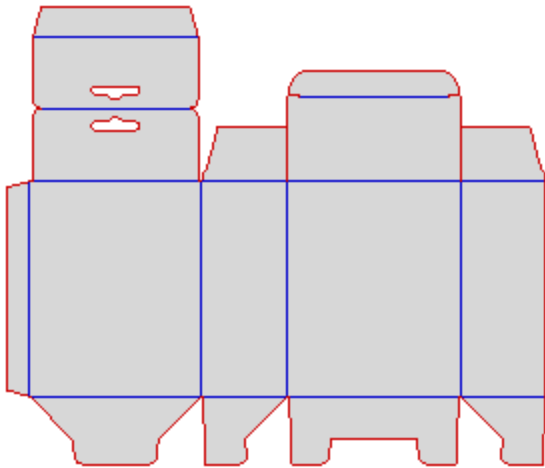

Semi-Auto Lock

LT020201

Straight line

Compact & E flute

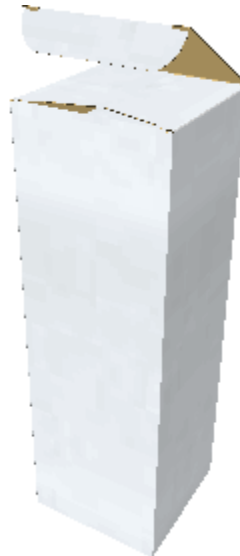
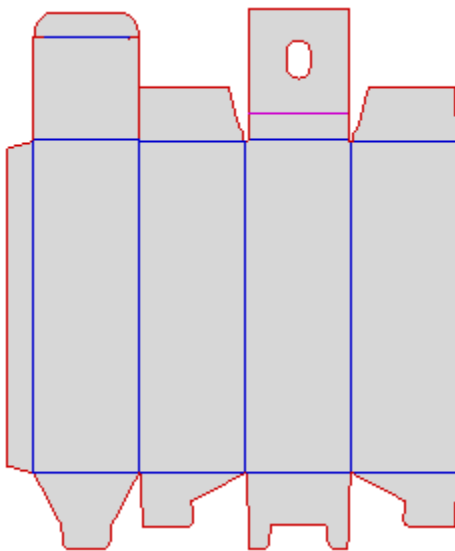

Semi-Auto Lock

LT020300

Straight line

Compact & E flute

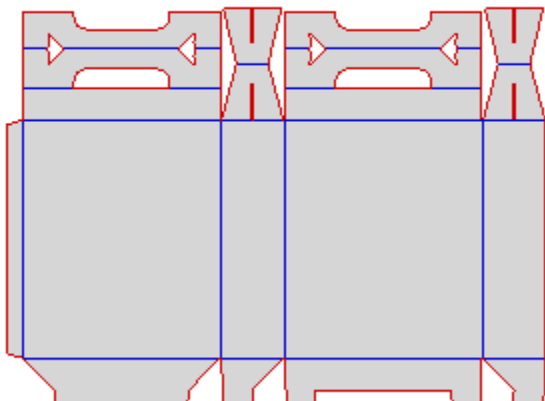

Semi-Auto Lock

LT020402

Straight line

Compact & E flute

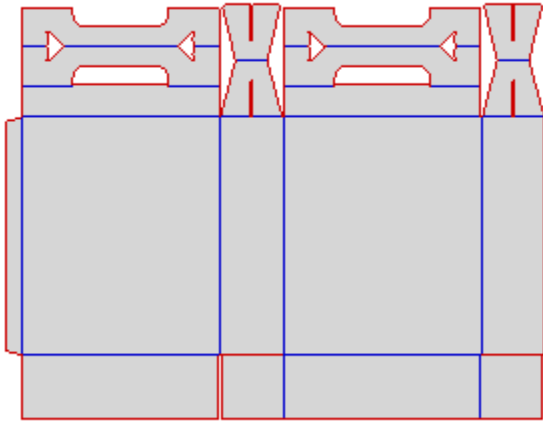

Semi-Auto Lock

LT020202

Straight line

Compact & E flute

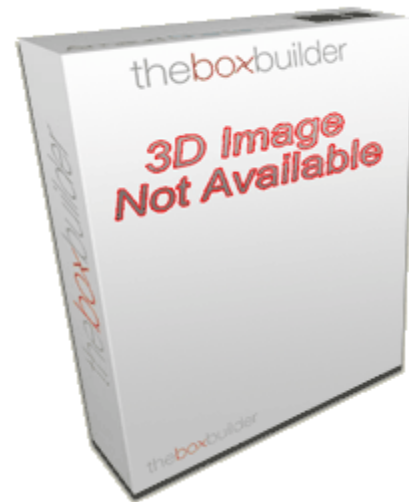
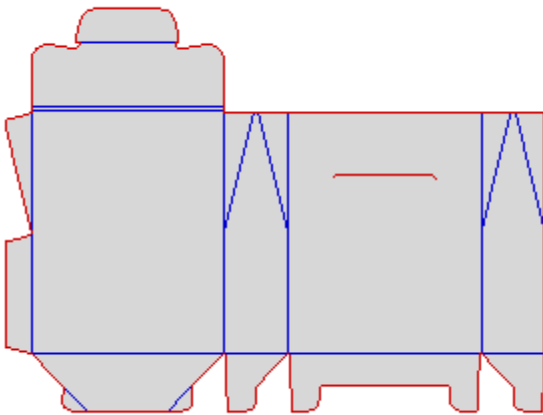

Semi-Auto Lock

LT024001

Straight line

Compact & E flute

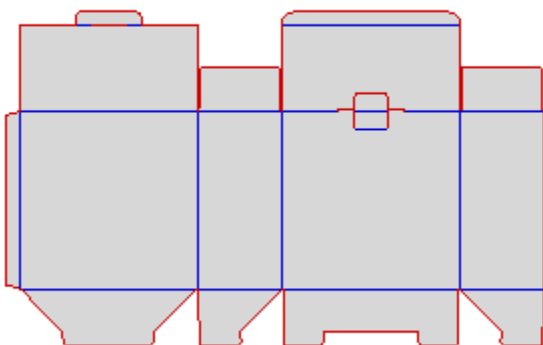

Semi-Auto Lock

LT020401

Straight line

Compact & E flute

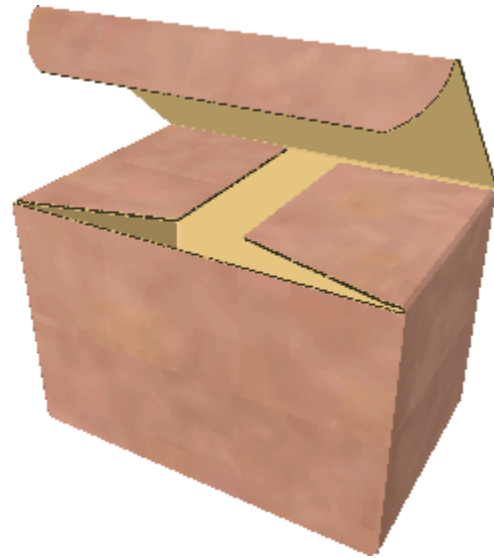
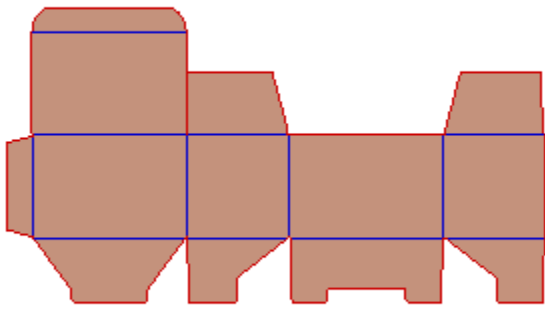

Semi-Auto Lock

OT020100

Straight line

Corrugated

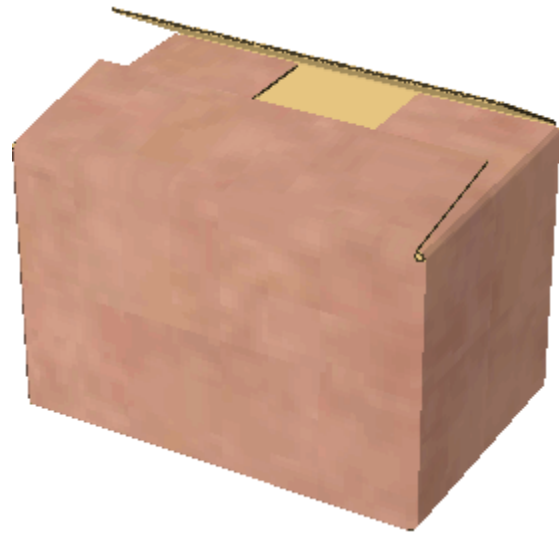
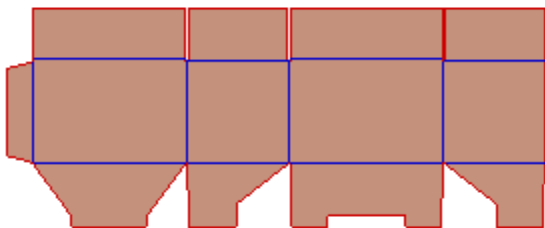

Semi-Auto Lock

OT023001

Straight line

Corrugated

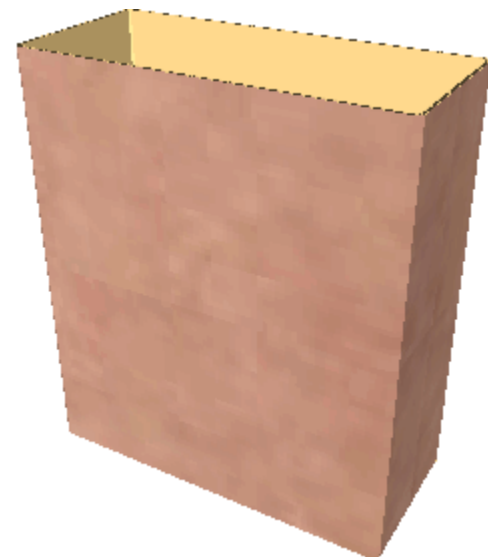
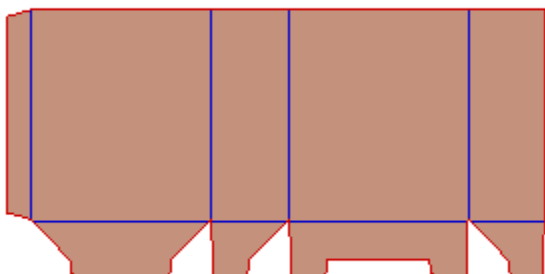

Semi-Auto Lock

OT020002

Straight line

Corrugated

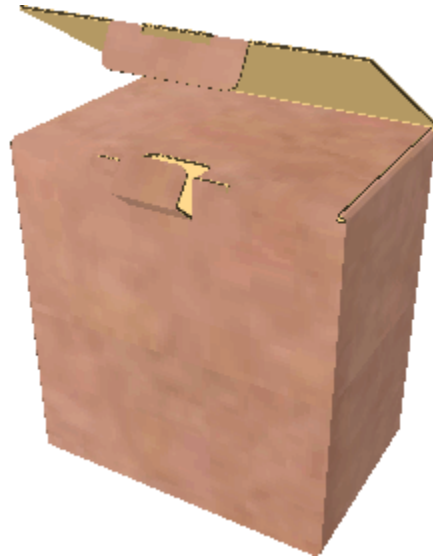
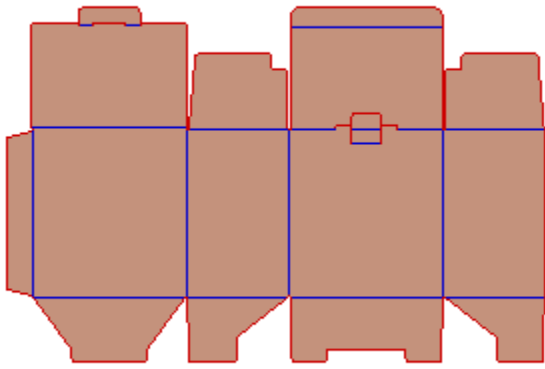

Semi-Auto Lock

OT020401

Straight line

Corrugated

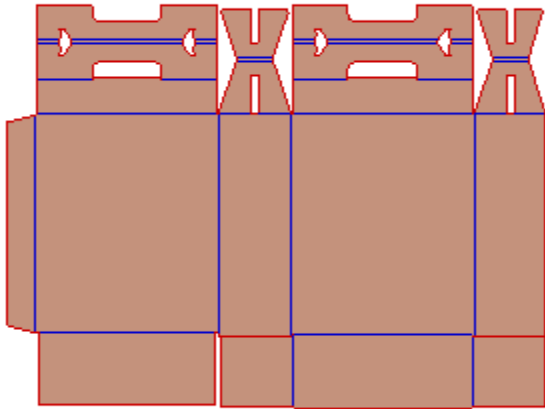

Semi-Auto Lock

OT020202

Straight line

Corrugated

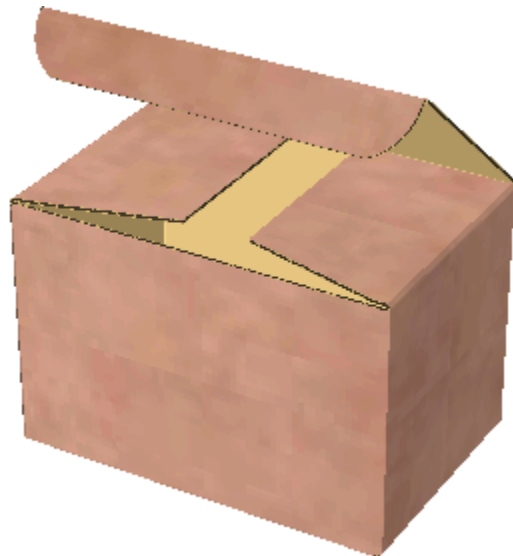
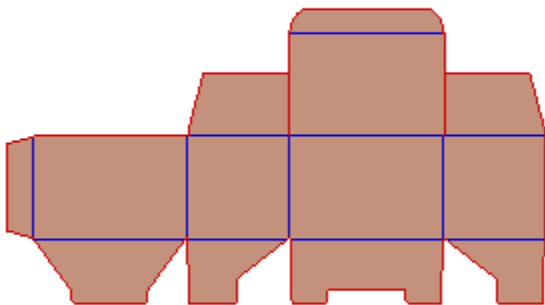

Semi-Auto Lock

OT020101

Straight line

Corrugated

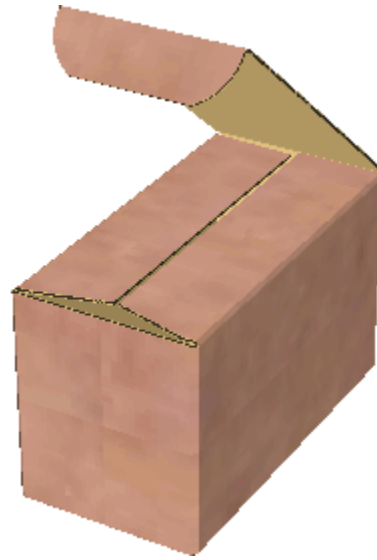
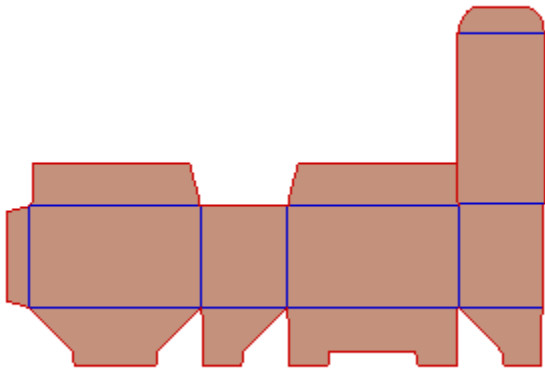

Semi-Auto Lock

OT020102

Straight line

Corrugated

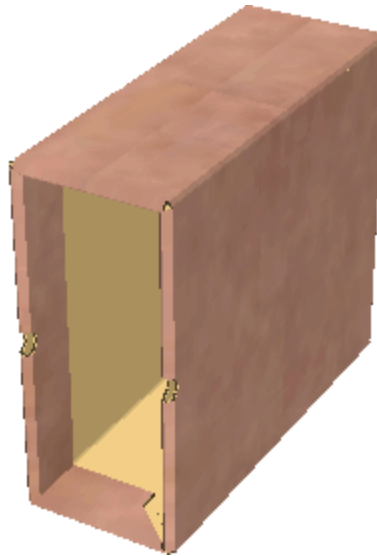
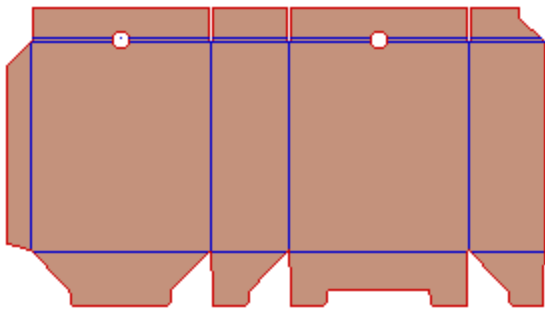

Semi-Auto Lock

OT020001

Straight line

Corrugated

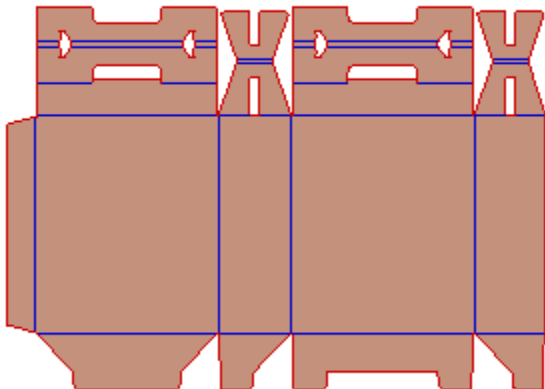

Semi-Auto Lock

OT020402

Straight line

Corrugated

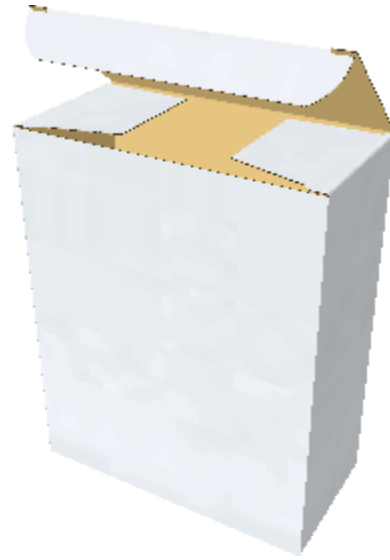
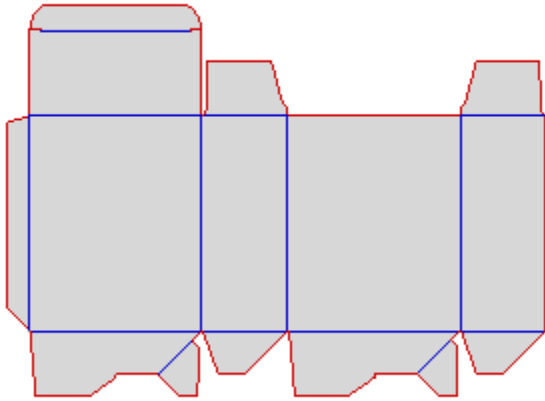

Crash Lock Bottom

LT030101

Compact & E flute

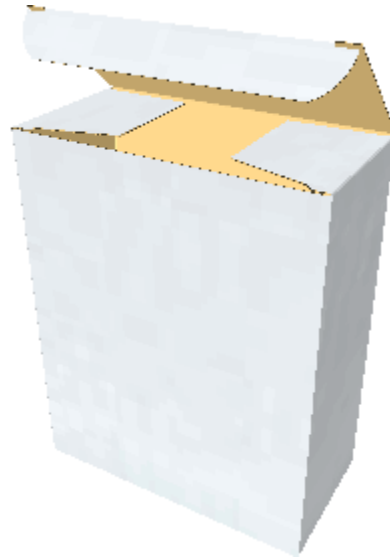
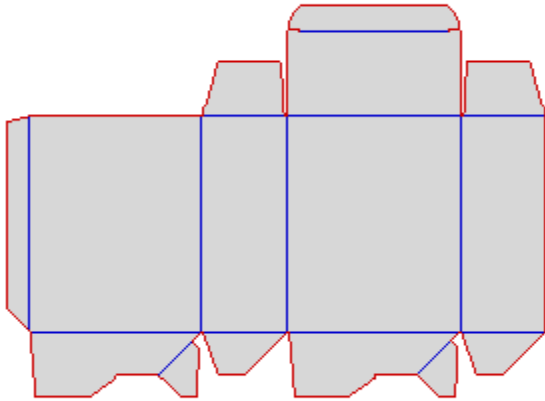

Crash Lock Bottom

LT030110

Compact & E flute

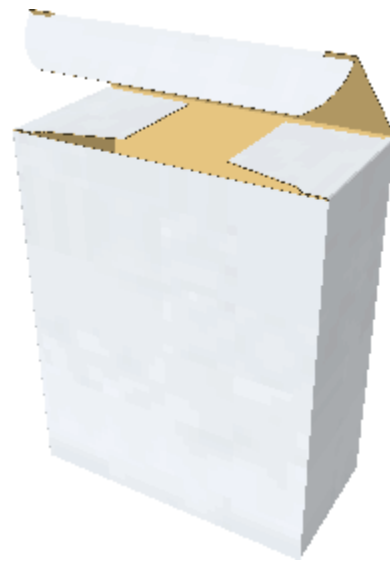
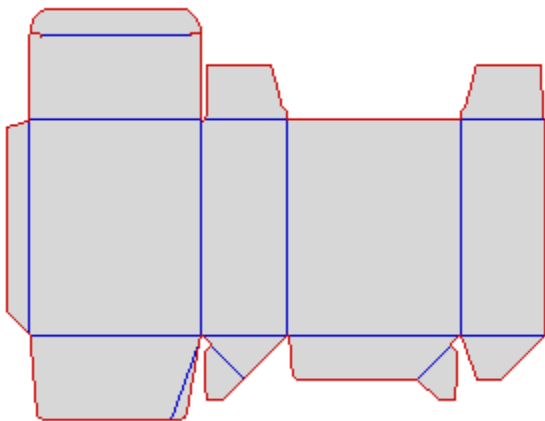

Crash Lock Bottom

LT032101

Compact & E flute

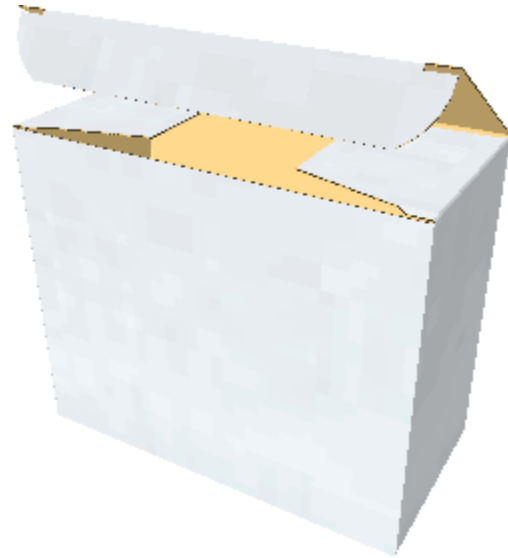
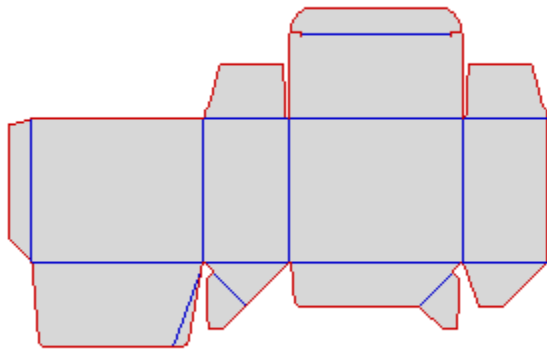

Crash Lock Bottom

LT032110

Compact & E flute

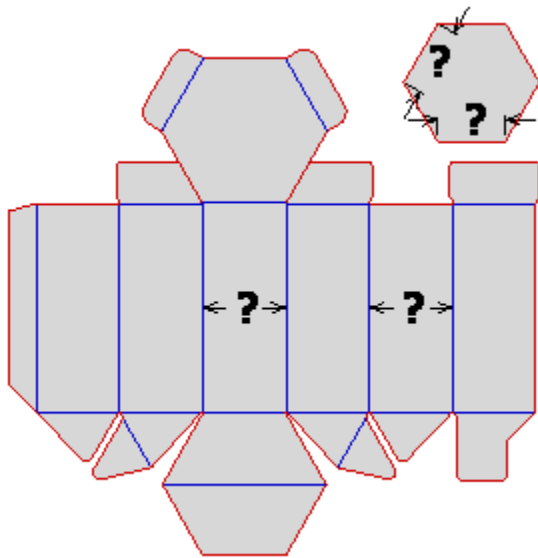

Crash Lock Bottom

LT030127

Crash lock bottom

Compact & E flute

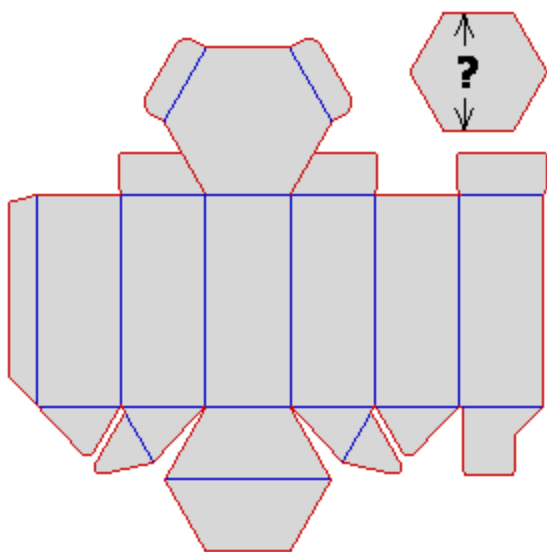

Crash Lock Bottom

LT030128

Crash lock bottom

Compact & E flute

		Crash Lock Bottom	
<p>LT030125</p>	<p>Crash lock bottom</p>		<p>Compact & E flute</p>
			Crash Lock Bottom
<p>LT030126</p>	<p>Crash lock bottom</p>	<p>Compact & E flute</p>	
		Crash Lock Bottom	
<p>LT032125</p>	<p>Crash lock bottom</p>		<p>Compact & E flute</p>

		Crash Lock Bottom	
<p>LT032126</p>	<p>Crash lock bottom</p>		<p>Compact & E flute</p>
			Crash Lock Bottom
<p>LT030129</p>	<p>Crash lock bottom</p>	<p>Compact & E flute</p>	
		Crash Lock Bottom	
<p>LT030130</p>	<p>Crash lock bottom</p>		<p>Compact & E flute</p>

		<p style="writing-mode: vertical-rl; transform: rotate(180deg);">Crash Lock Bottom</p>
<p>LT032127</p>	<p>Crash lock bottom</p>	
		<p style="writing-mode: vertical-rl; transform: rotate(180deg);">Crash Lock Bottom</p>
<p>LT032128</p>	<p>Crash lock bottom</p>	
		<p style="writing-mode: vertical-rl; transform: rotate(180deg);">Crash Lock Bottom</p>
<p>LT030001</p>	<p>Crash lock bottom</p>	

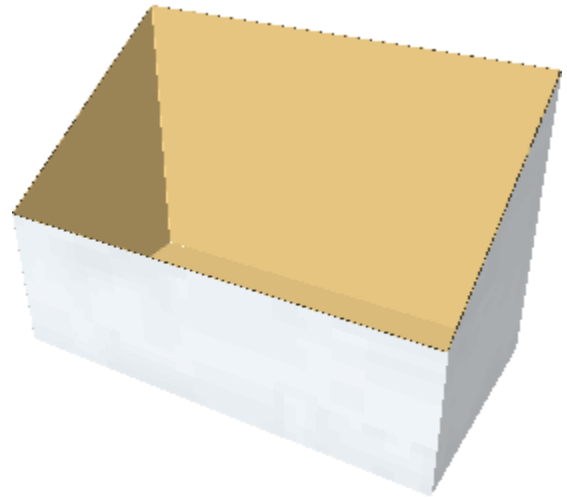
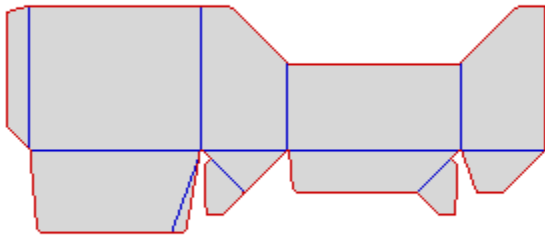

Crash Lock Bottom

LT030002

Compact & E flute

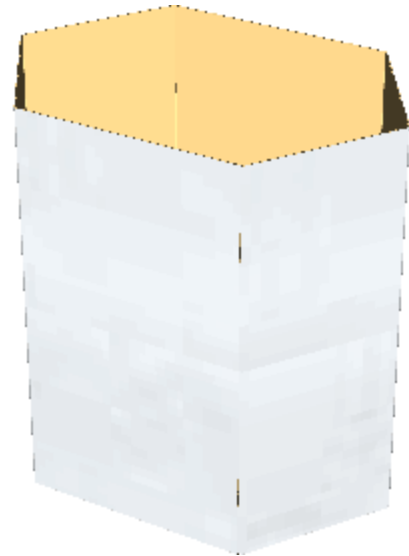
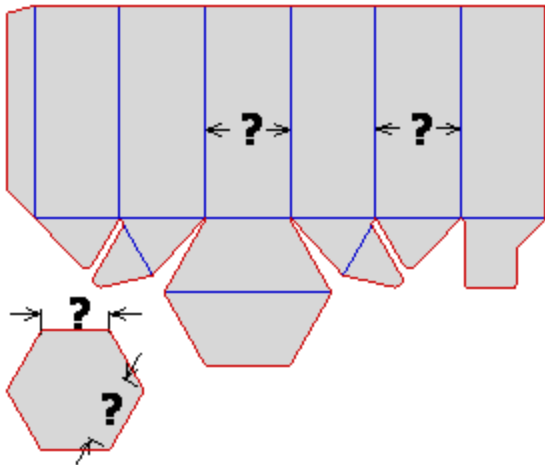

Crash Lock Bottom

LT030003

Crash lock bottom

Compact & E flute

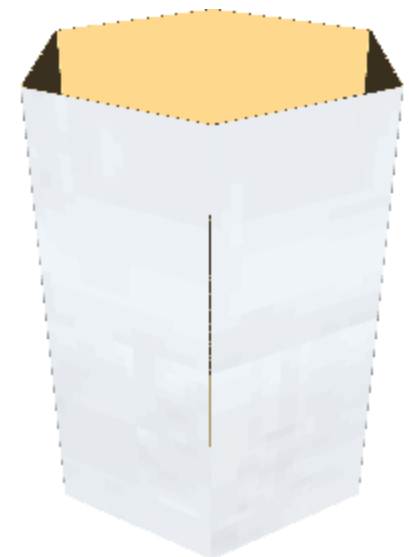
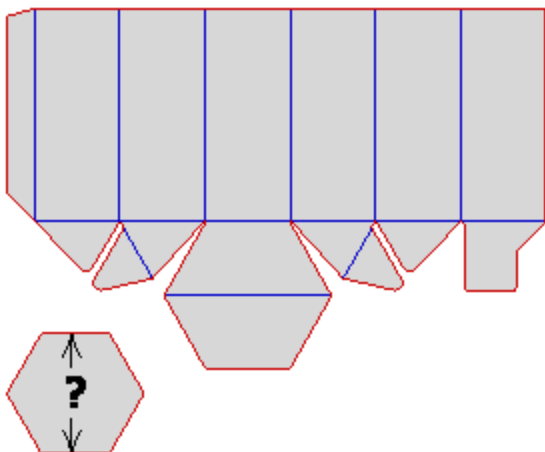

Crash Lock Bottom

LT030004

Crash lock bottom

Compact & E flute

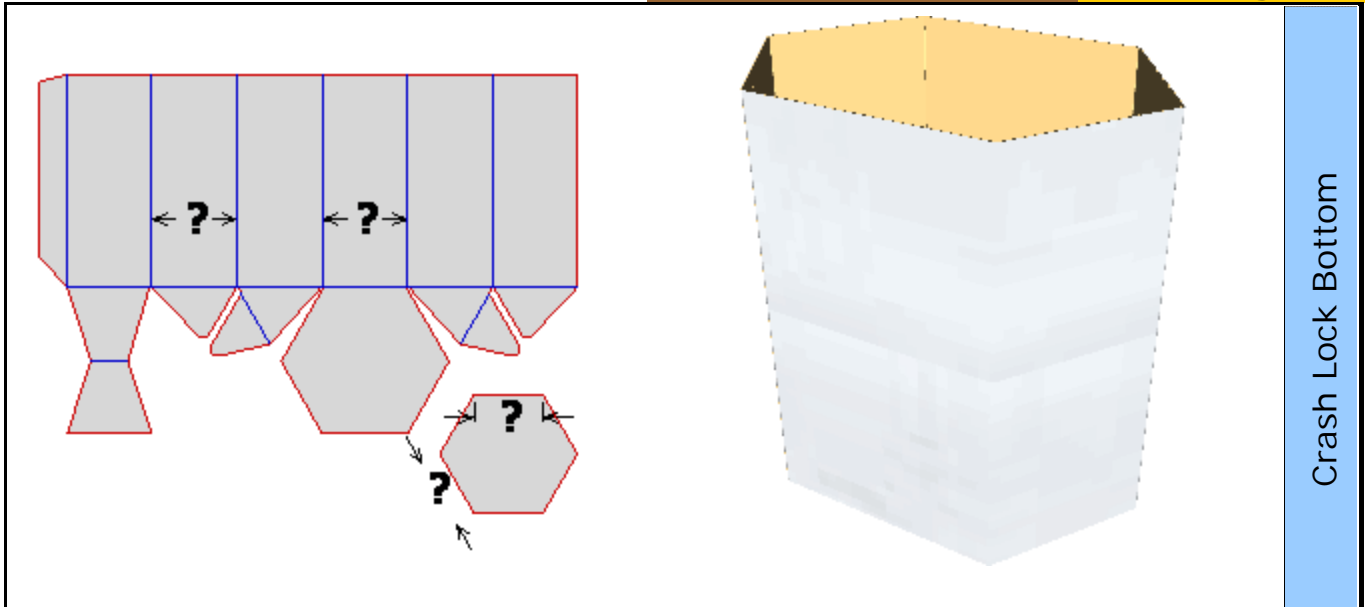

Crash Lock Bottom

LT030005

Crash lock bottom

Compact & E flute

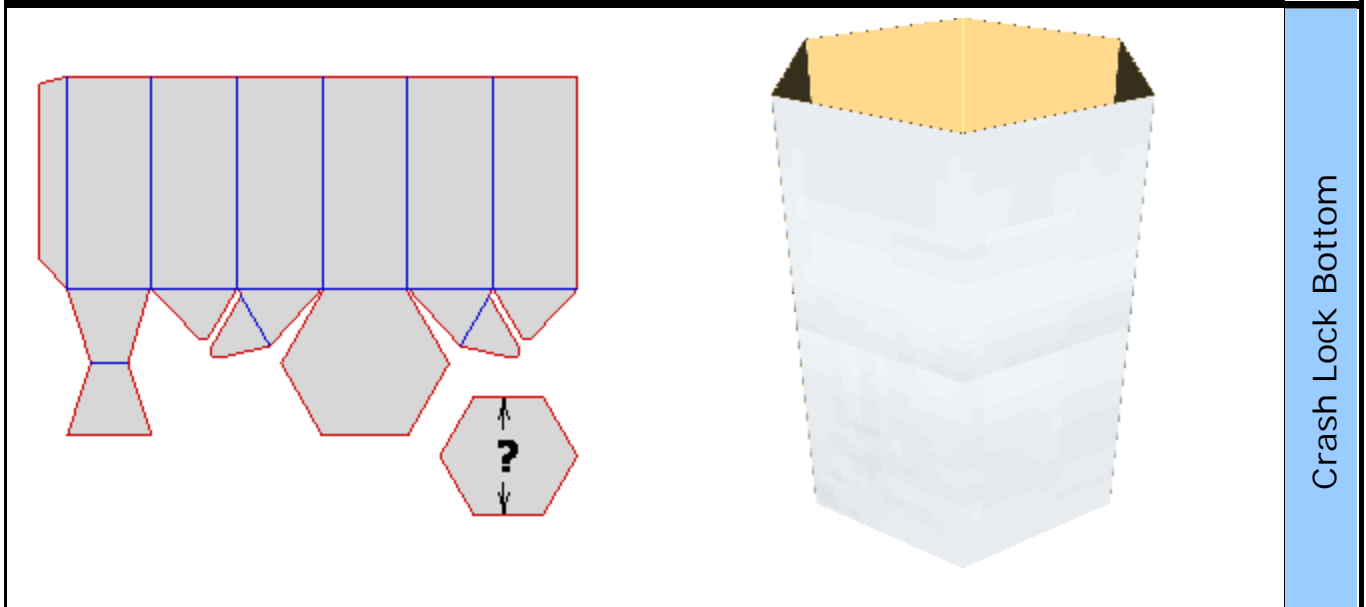

Crash Lock Bottom

LT030006

Crash lock bottom

Compact & E flute

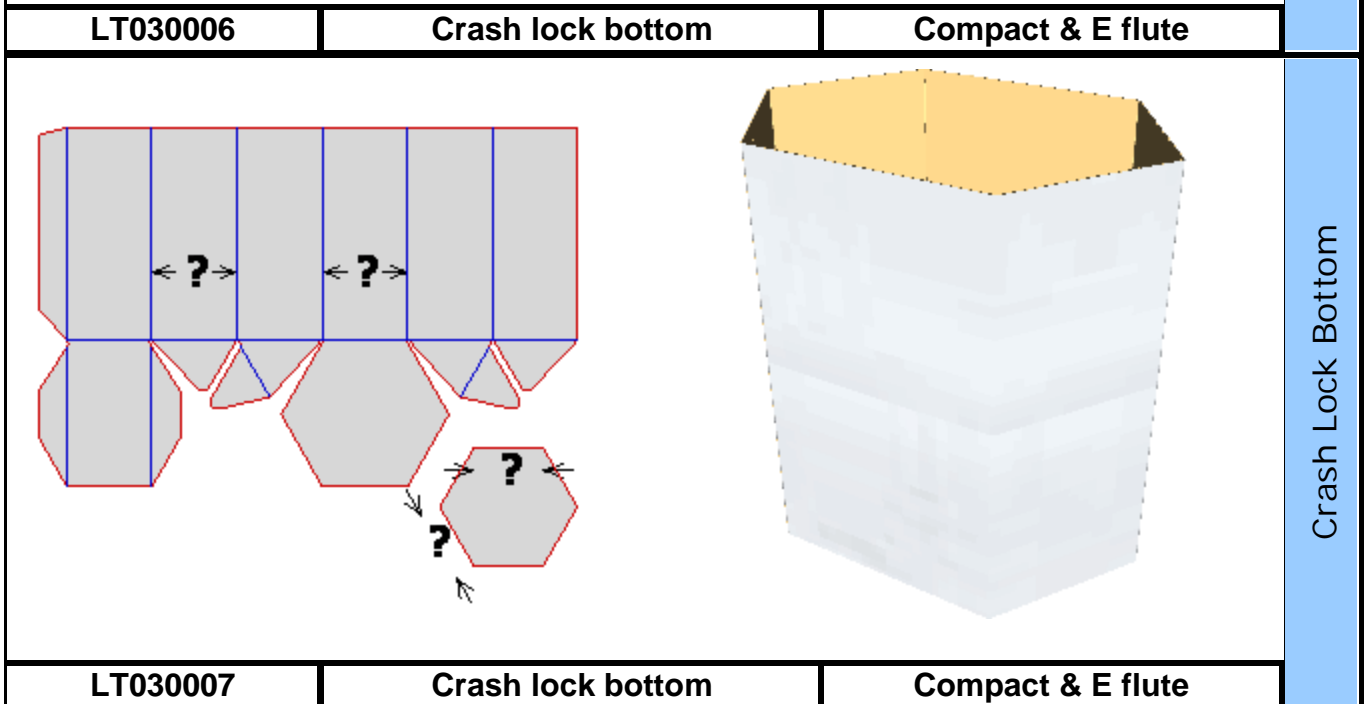

Crash Lock Bottom

LT030007

Crash lock bottom

Compact & E flute

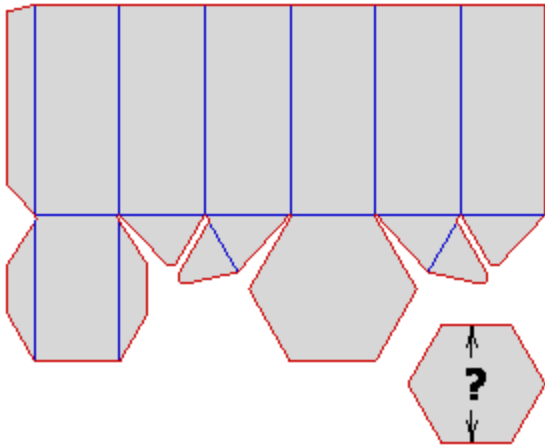

Crash Lock Bottom

LT030008

Crash lock bottom

Compact & E flute

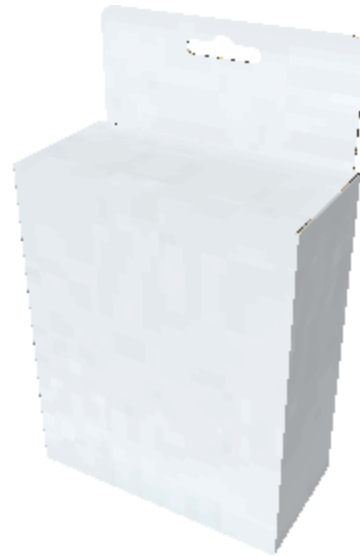
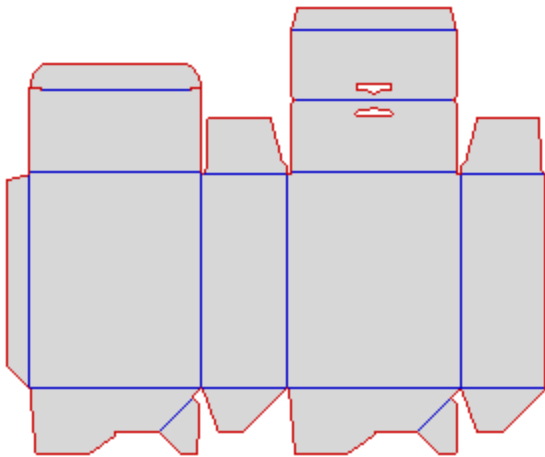

Crash Lock Bottom

LT030201

Compact & E flute

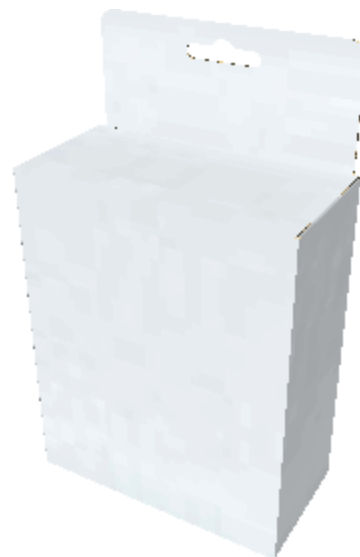
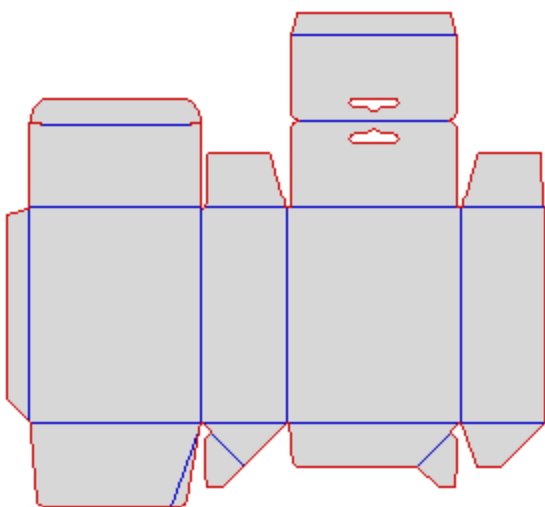

Crash Lock Bottom

LT032201

Compact & E flute

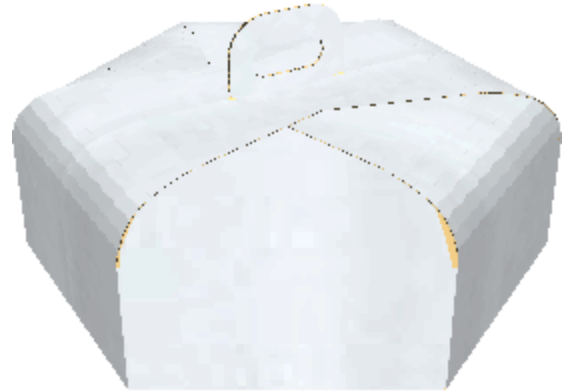
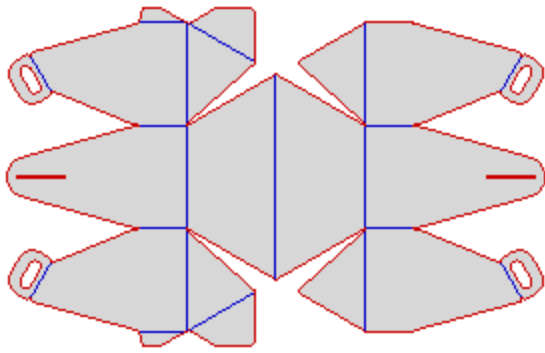

Crash Lock Bottom

LT033100

Crash lock bottom

Compact

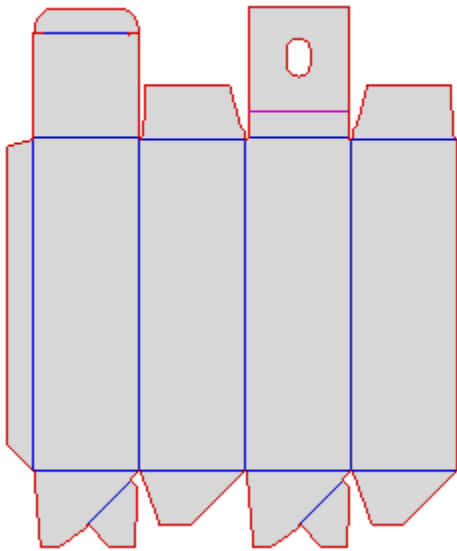

Crash Lock Bottom

LT030301

Compact & E flute

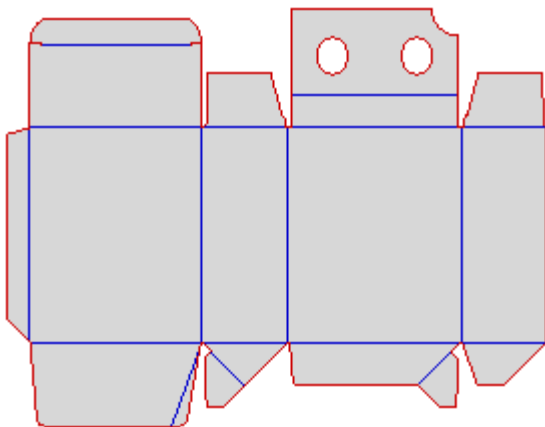

Crash Lock Bottom

LT032301

Compact & E flute

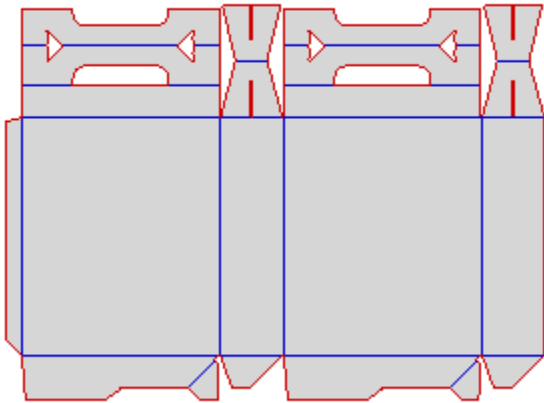

Crash Lock Bottom

LT030310

Compact & E flute

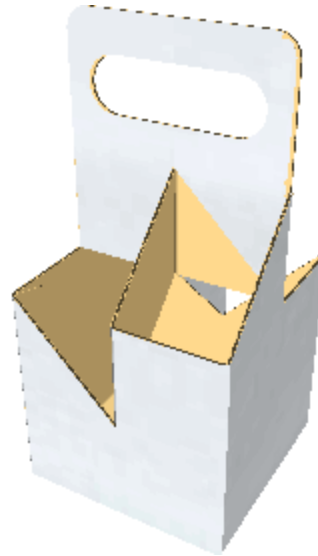
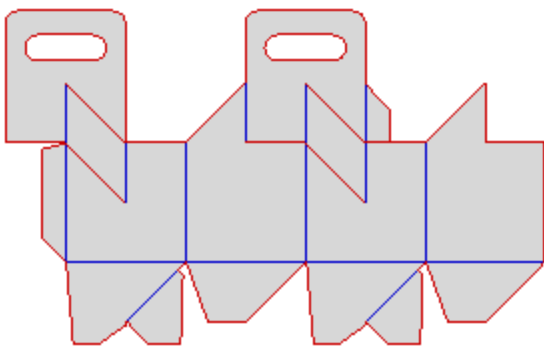

Crash Lock Bottom

LT030302

Compact & E flute

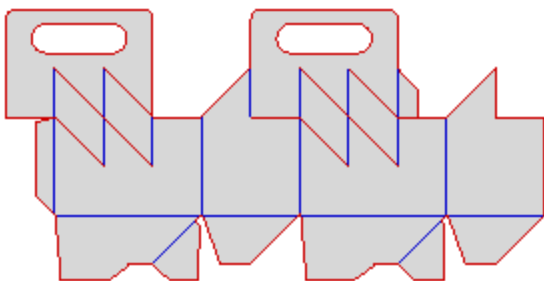

Crash Lock Bottom

LT030303

Compact & E flute

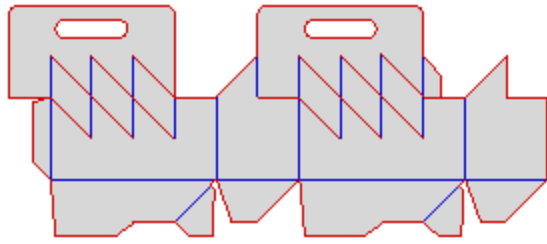

Crash Lock Bottom

LT030304

Compact & E flute

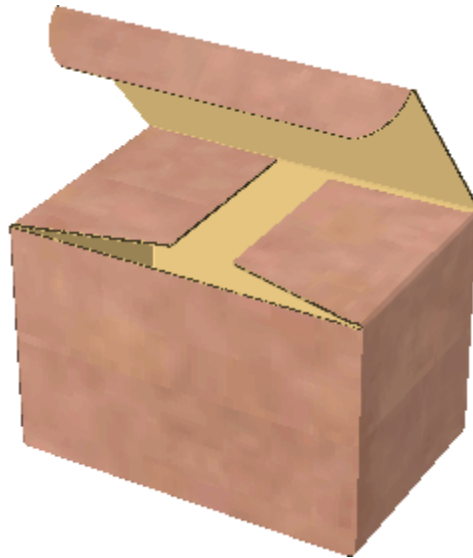
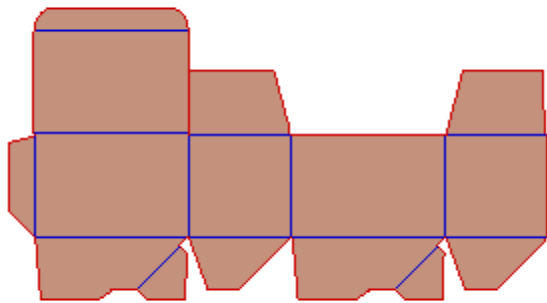

Crash Lock Bottom

OT030102

Corrugated

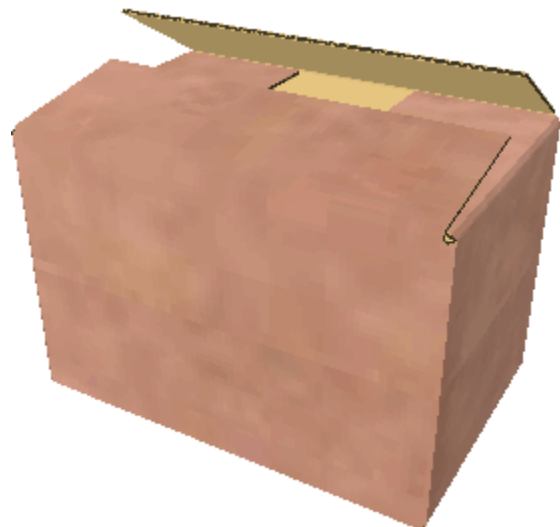
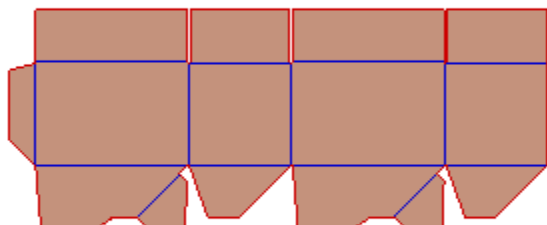

Crash Lock Bottom

OT030401

Corrugated

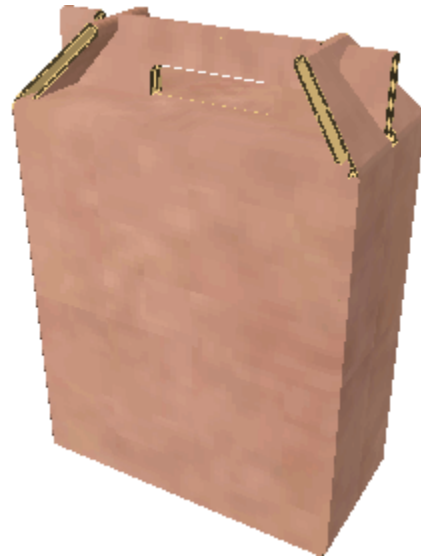
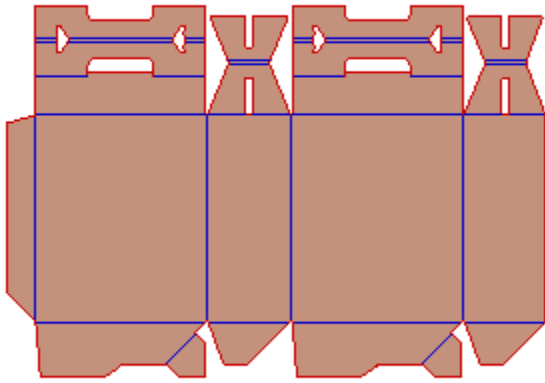

Crash Lock Bottom

OT030310

Corrugated

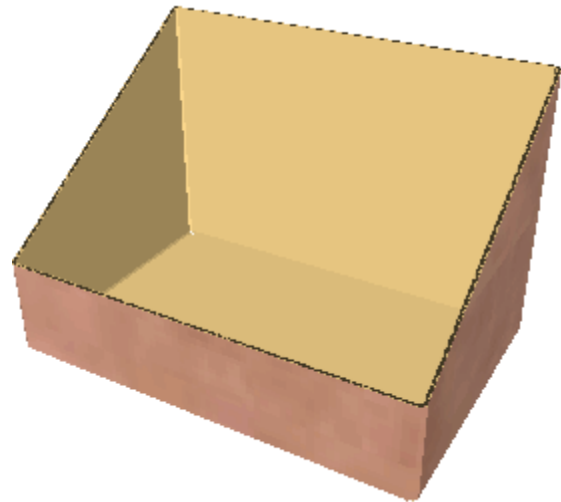
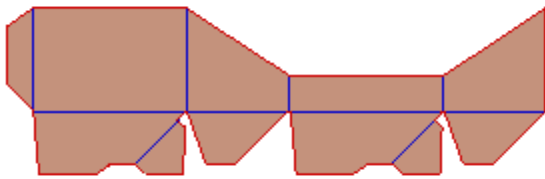

Crash Lock Bottom

OT030001

Corrugated

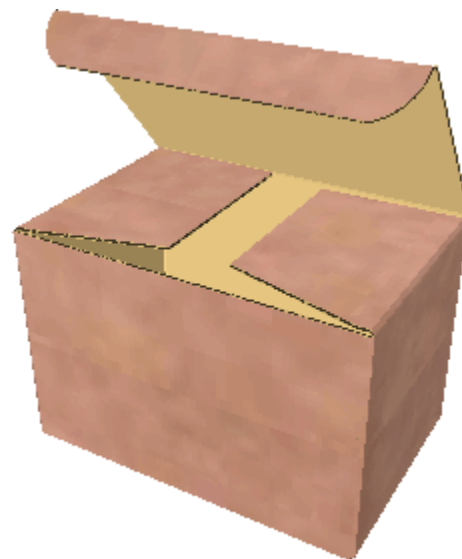
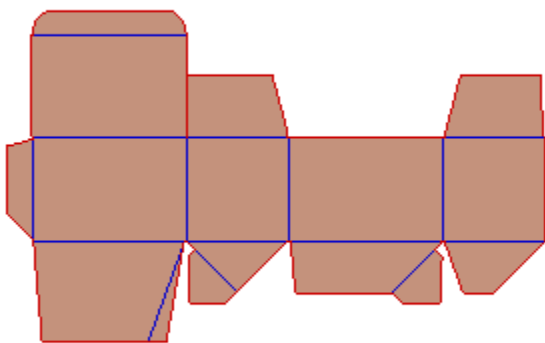

Crash Lock Bottom

OT032102

Corrugated

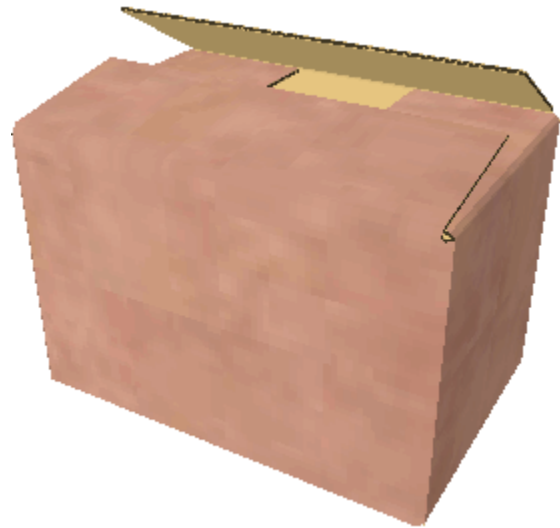
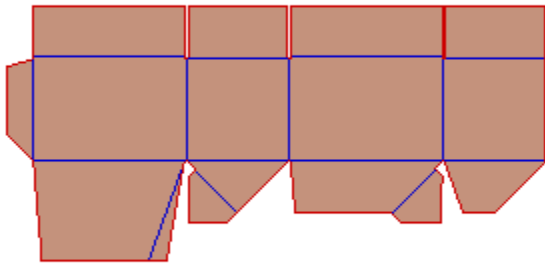

Crash Lock Bottom

OT032401

Corrugated

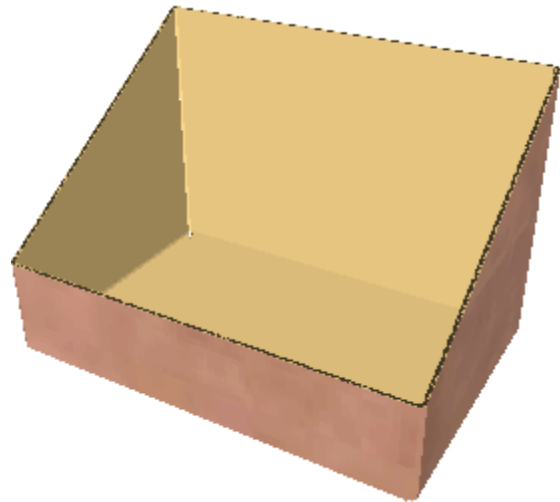
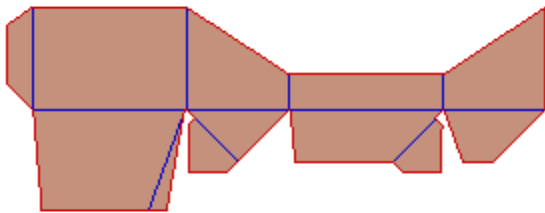

Crash Lock Bottom

OT030002

Corrugated

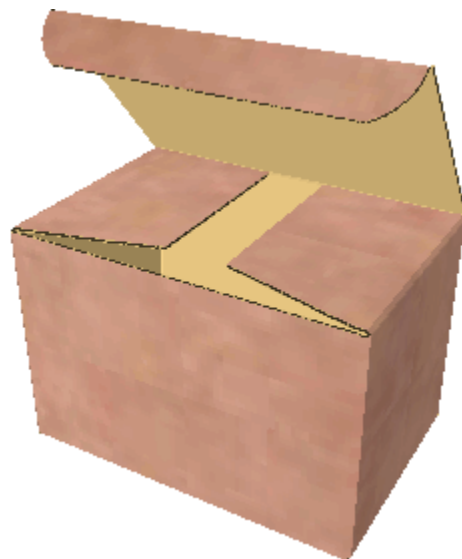
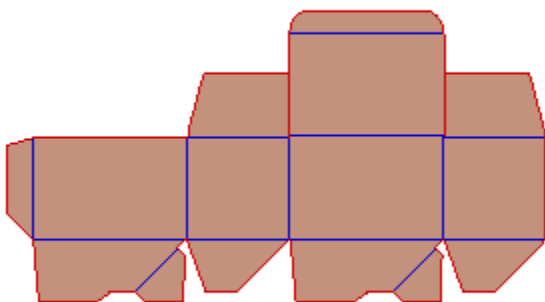

Crash Lock Bottom

OT030110

Corrugated

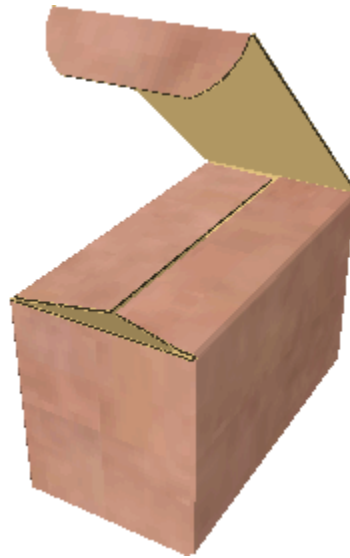
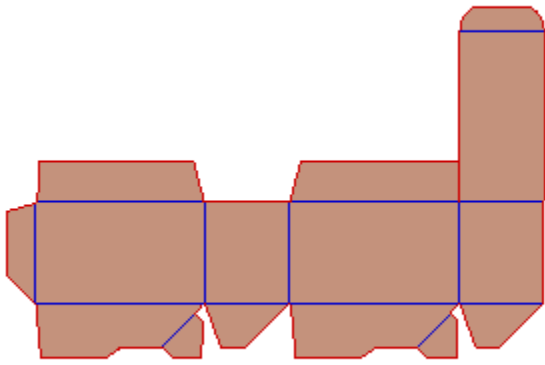

Crash Lock Bottom

OT030120

Corrugated

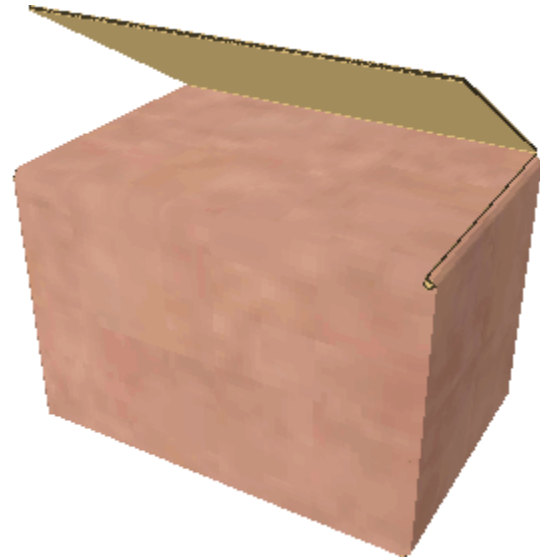
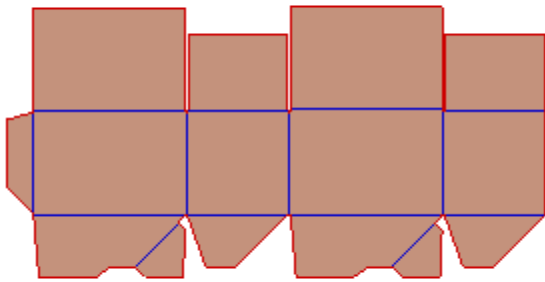

Crash Lock Bottom

OT030403

Corrugated

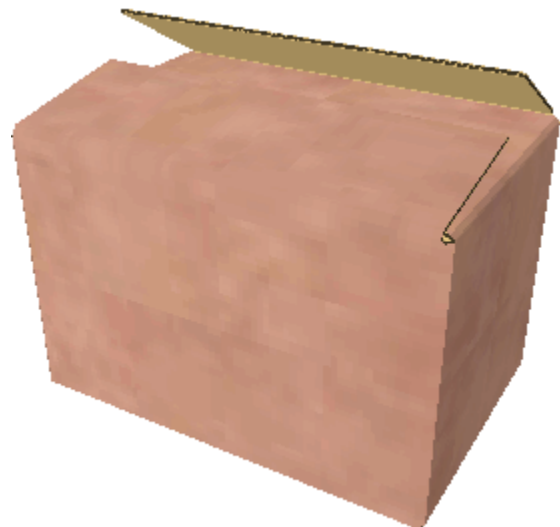
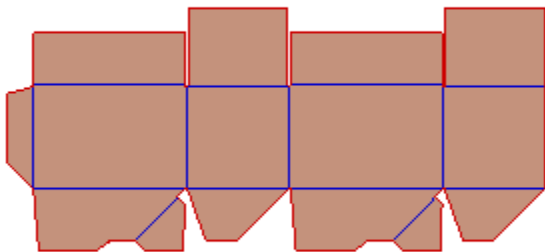

Crash Lock Bottom

OT030404

Corrugated

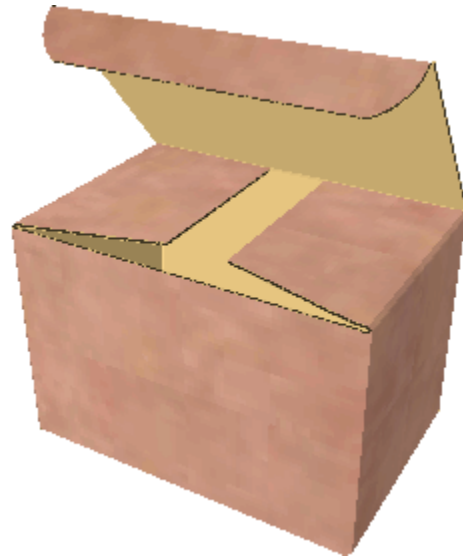
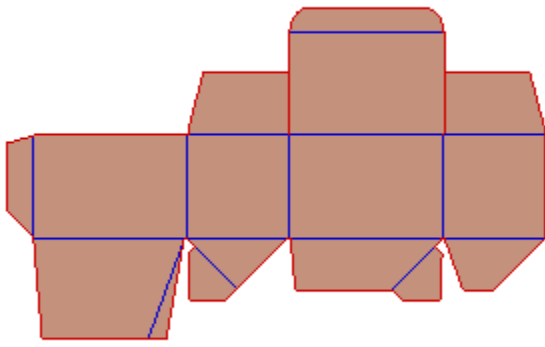

Crash Lock Bottom

OT032110

Corrugated

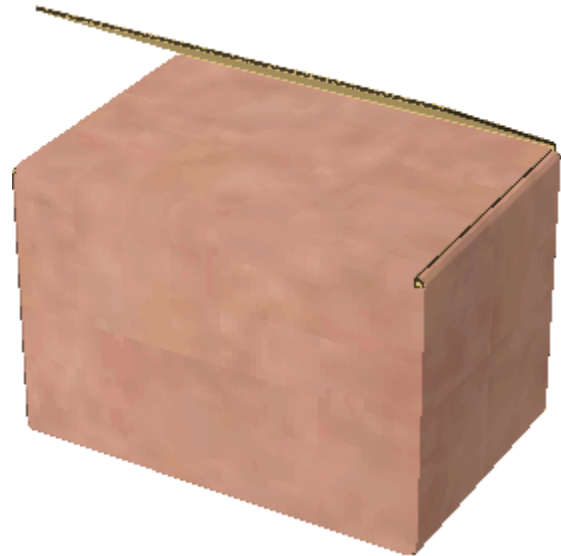
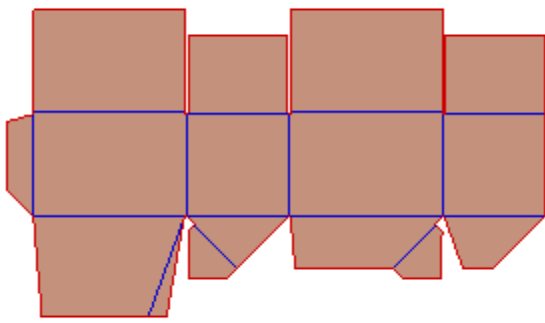

Crash Lock Bottom

OT032403

Corrugated

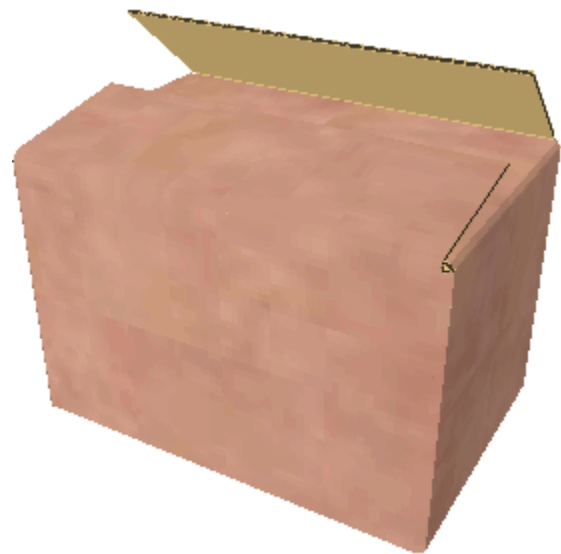
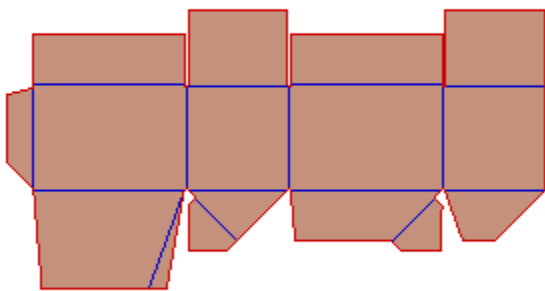

Crash Lock Bottom

OT032404

Corrugated

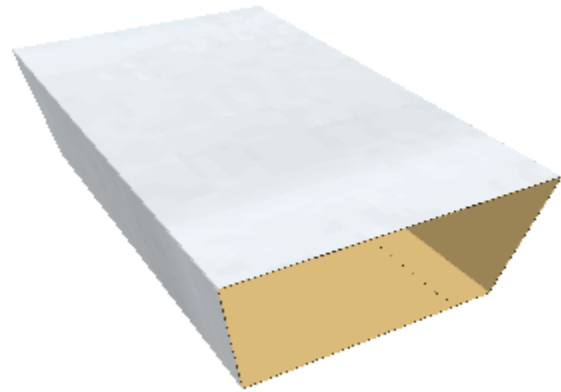
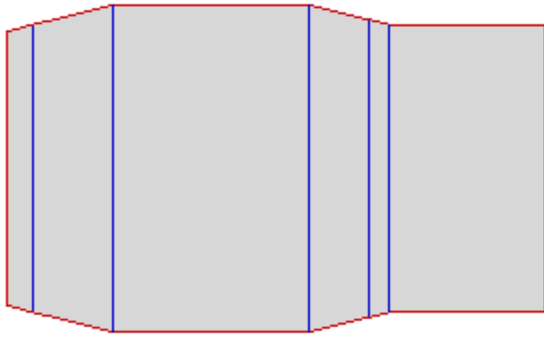

Sleeves

LT040003

Straight line

Compact & E flute

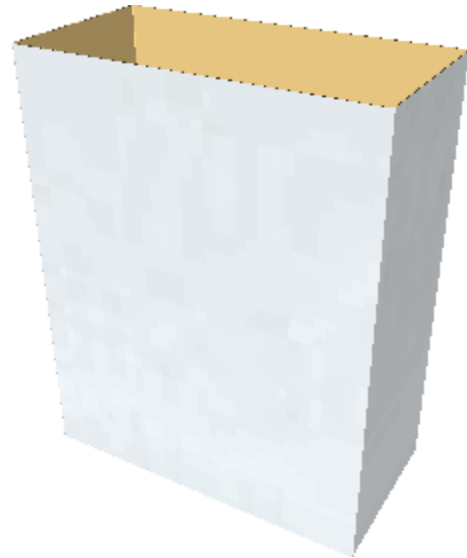
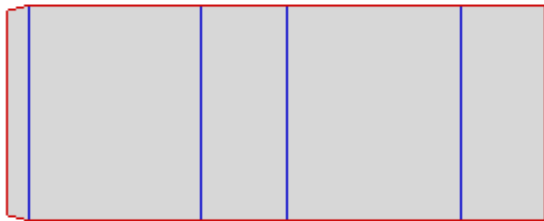

Sleeves

LT040001

Straight line

Compact & E flute

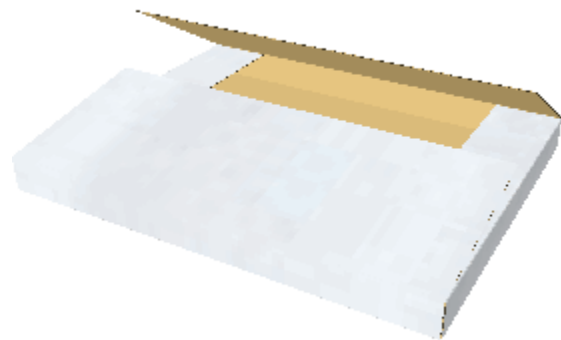
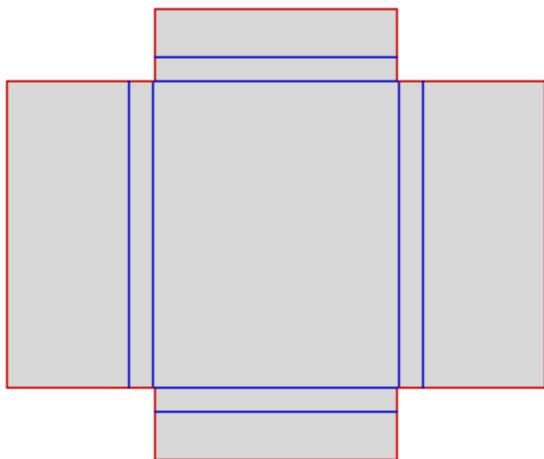

Sleeves

LT040201

Glue free

Compact & E flute

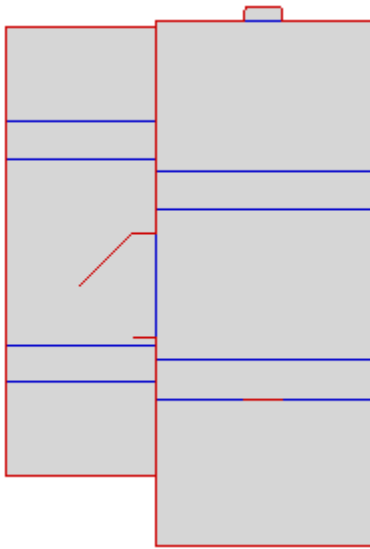

Sleeves

LT040004

Glue free

Compact & E flute

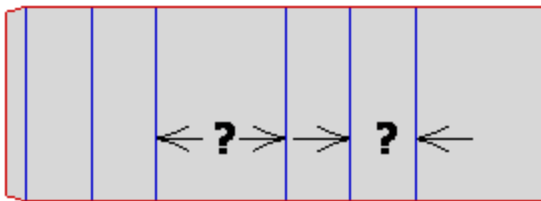

Sleeves

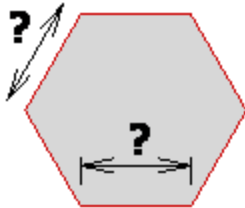

LT040020

Straight line

Compact & E flute

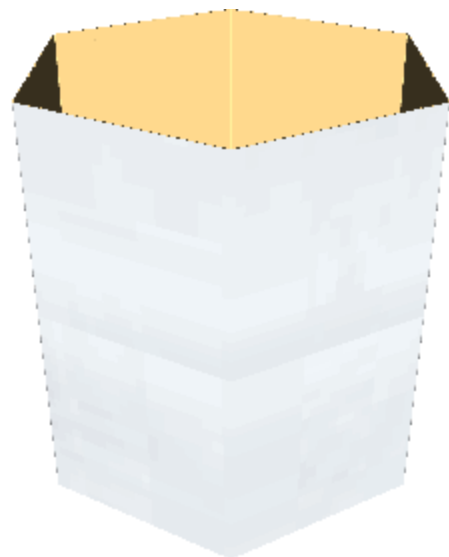

Sleeves

LT040021

Straight line

Compact & E flute

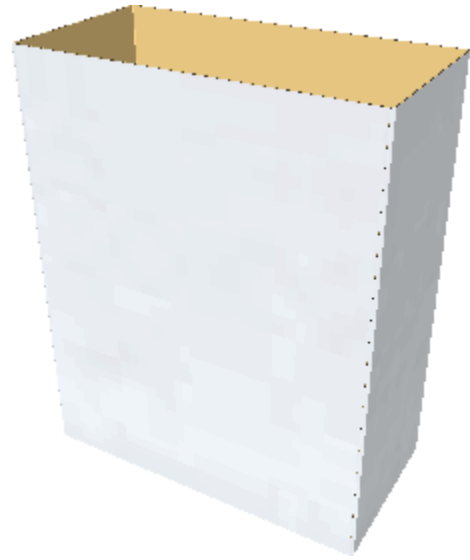

Sleeves

LT040002

Straight line

Compact & E flute

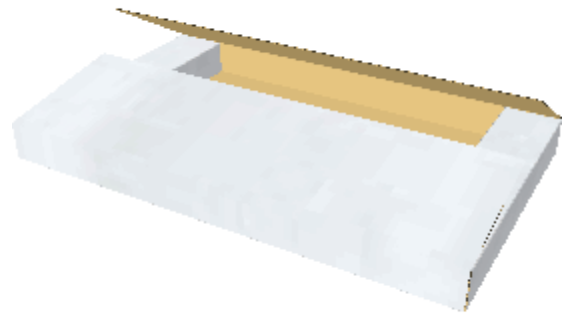
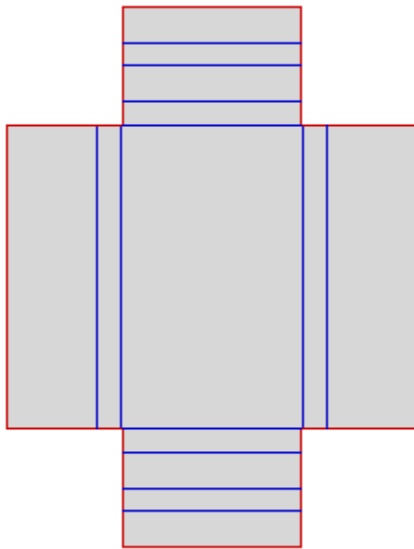

Sleeves

LT040202

Glue free

Compact & E flute

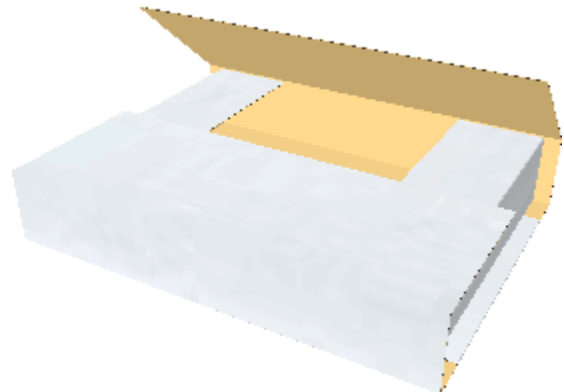
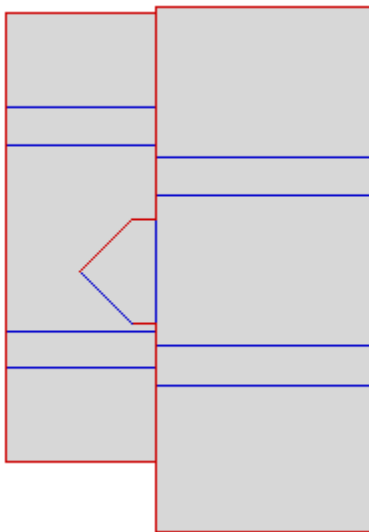

Sleeves

LT040005

Glue free

Compact & E flute

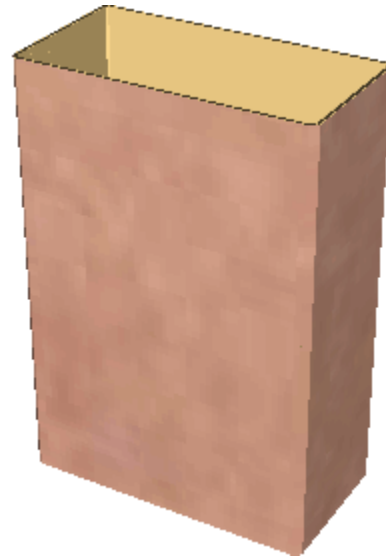
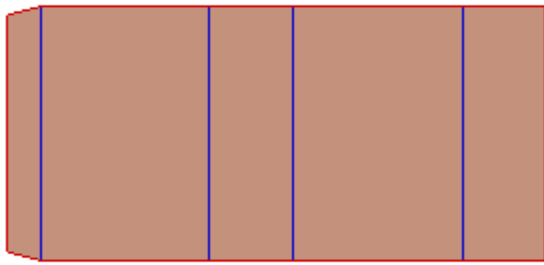

Sleeves

OT040001

Straight line

Corrugated

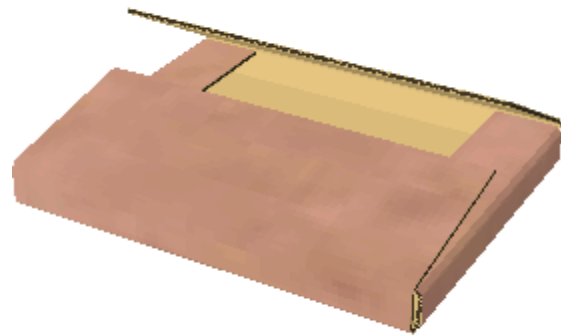
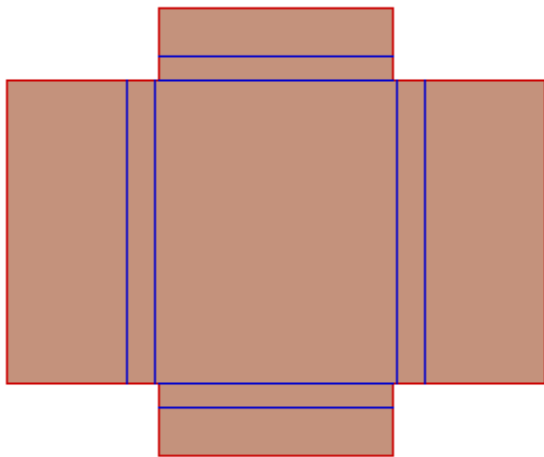

Sleeves

OT040201

Glue free

Corrugated

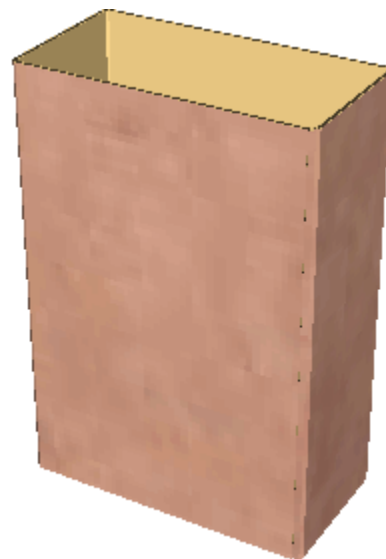

Sleeves

OT040002

Straight line

Corrugated

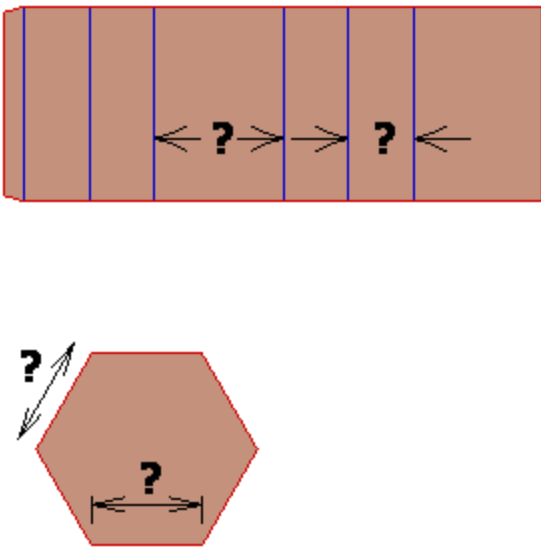
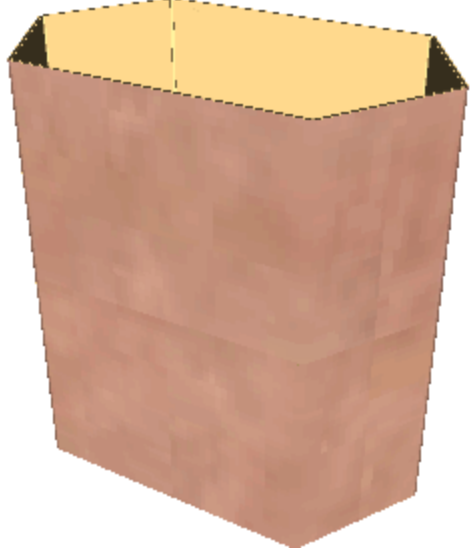
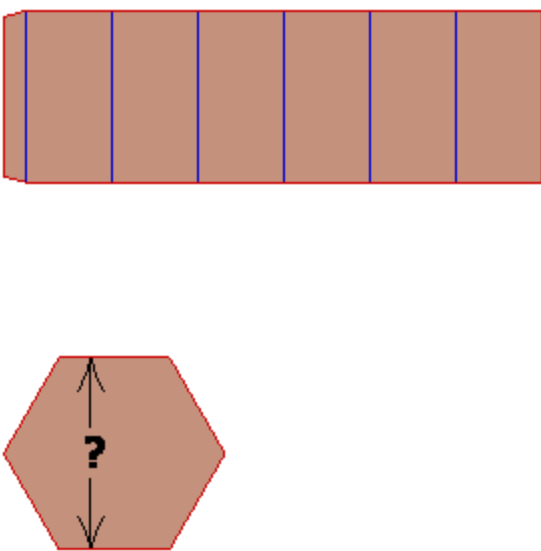
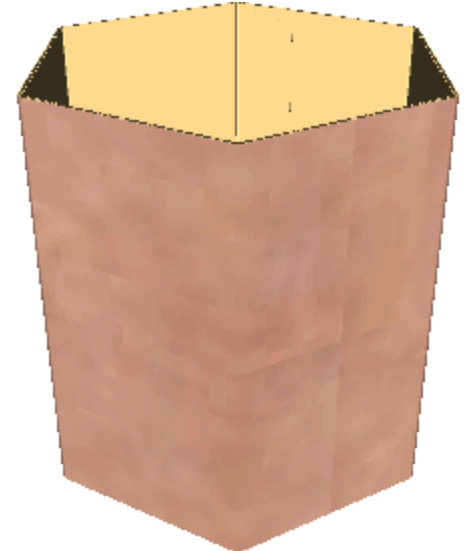
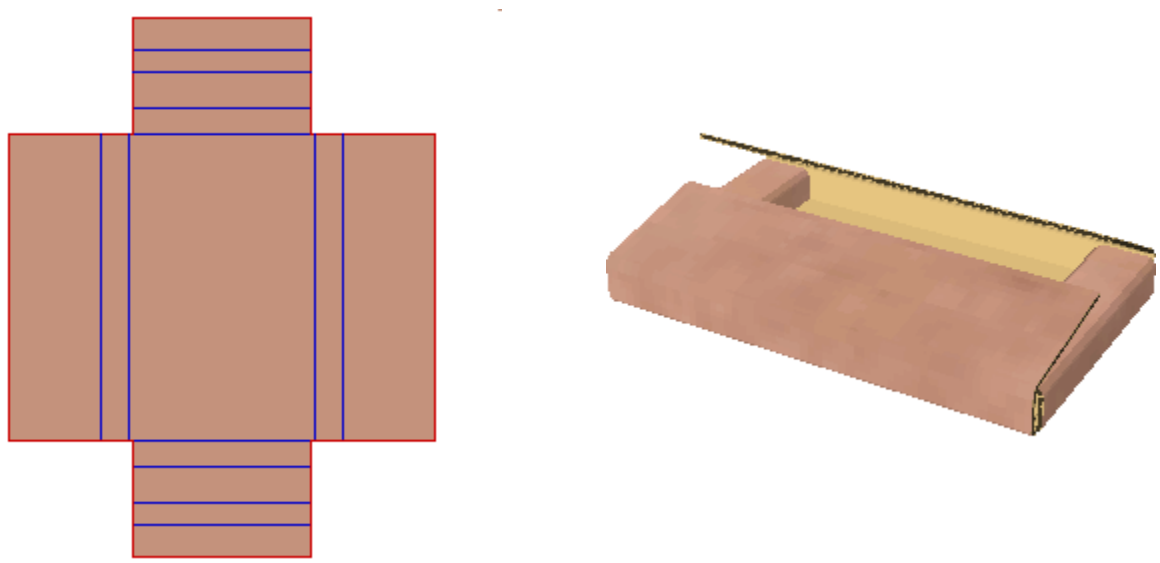
		Sleeves	
<p>OT040020</p>	<p>Straight line</p>		<p>Corrugated</p>
			Sleeves
<p>OT040021</p>	<p>Straight line</p>	<p>Corrugated</p>	
	<p>Glue free</p>	Sleeves	
<p>OT040202</p>	<p>Corrugated</p>		

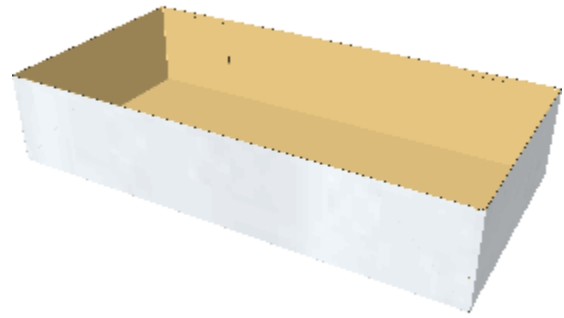
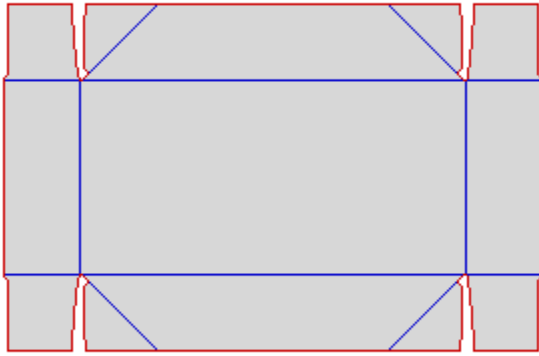

Glued Trays

LT050301

4 Corners

Compact & E flute

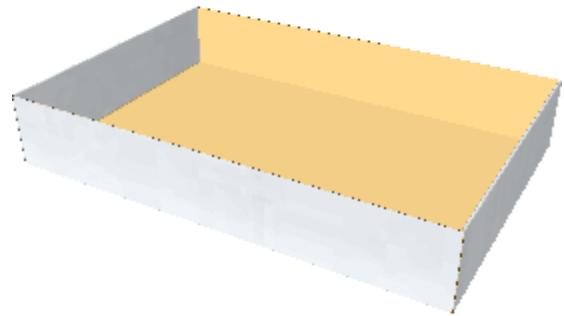
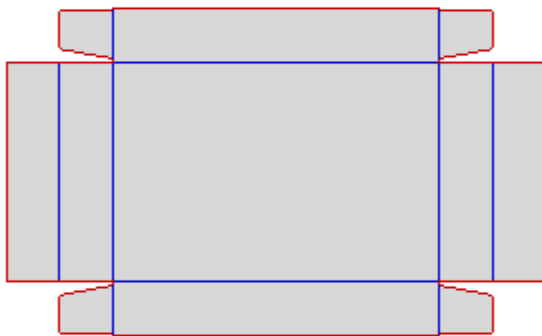

Glued Trays

LT050630

Packers

Compact & E flute

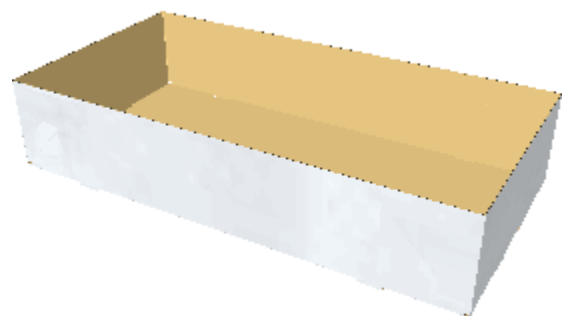
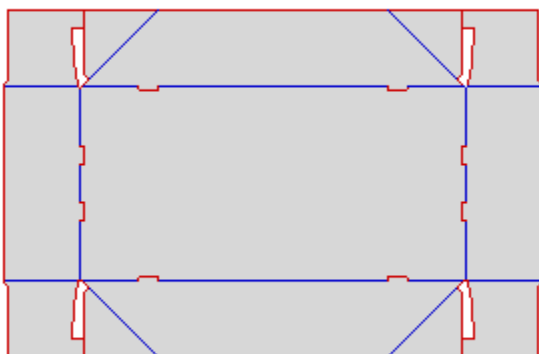

Glued Trays

LT050302

4 Corners

Compact & E flute

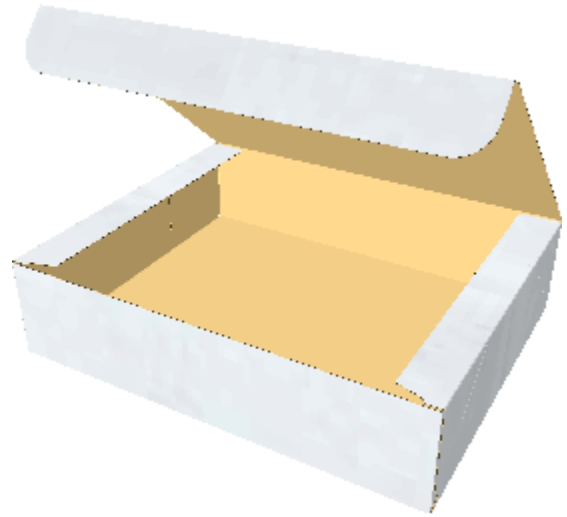
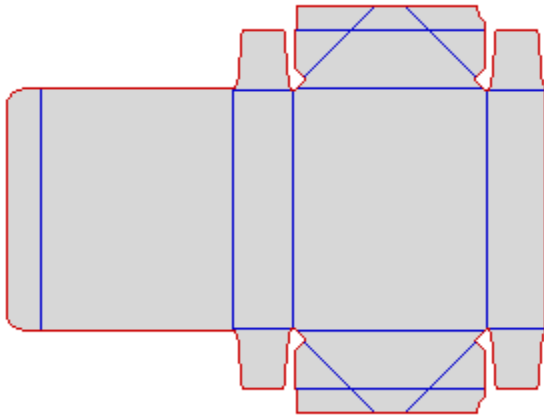

Glued Trays

LT050311

4 Corners

Compact & E flute

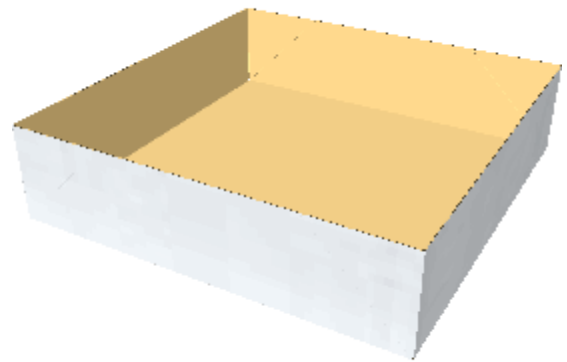
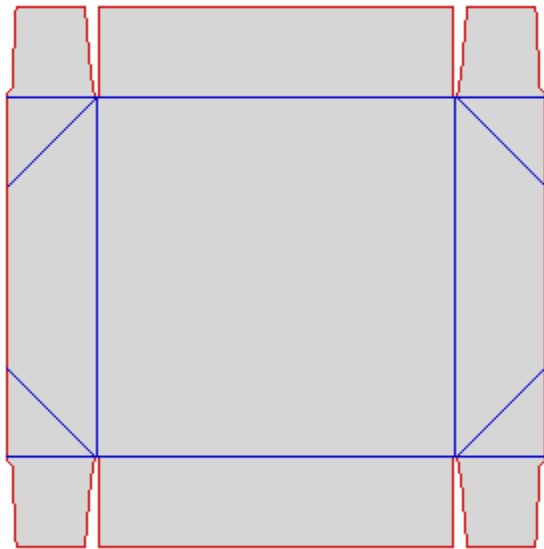

Glued Trays

LT050303

4 Corners

Compact & E flute

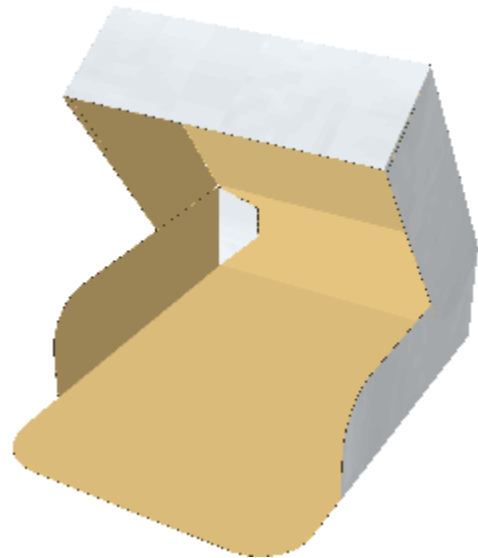
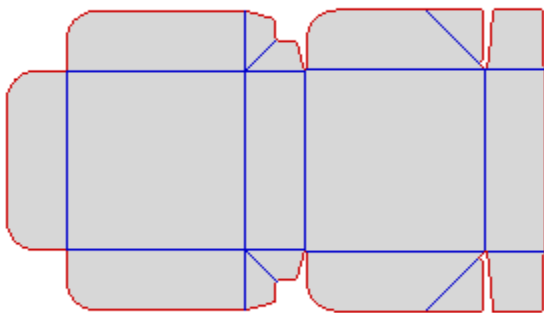

Glued Trays

LT051201

4 Corners

Compact & E flute

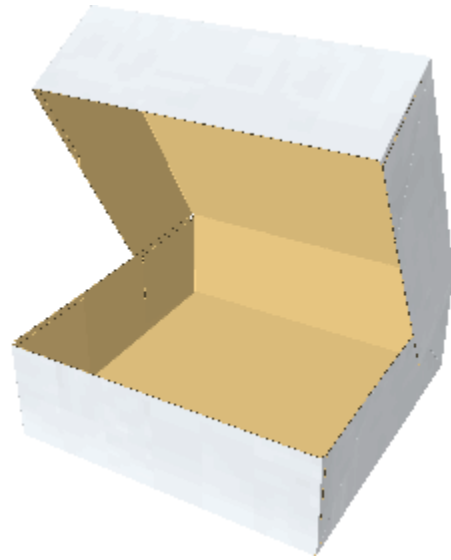
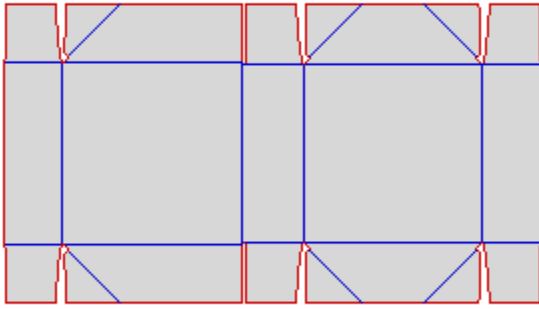

Glued Trays

LT050401

6 Corners

Compact & E flute

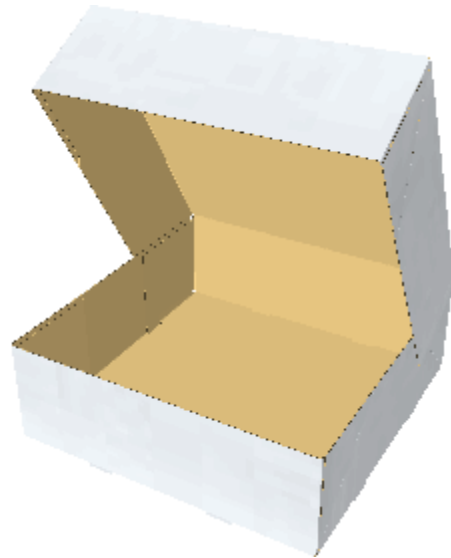
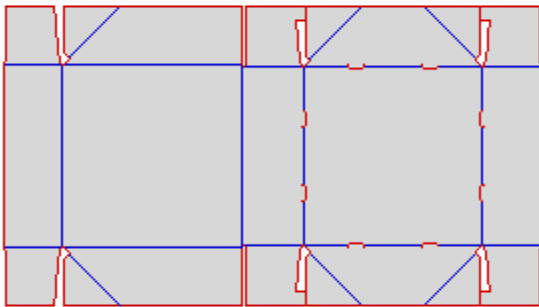

Glued Trays

LT050402

6 Corners

Compact & E flute

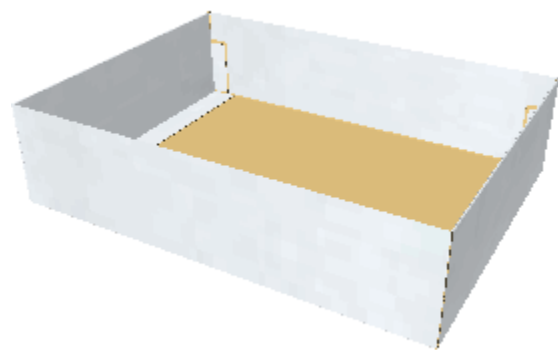
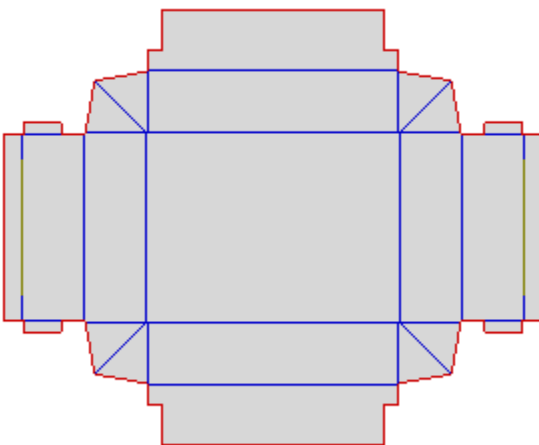

Glued Trays

LT050101

Straight line

Compact & E flute

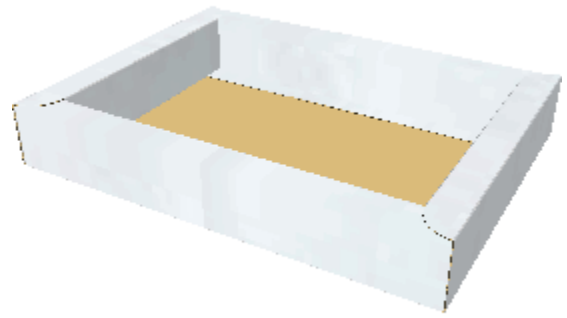
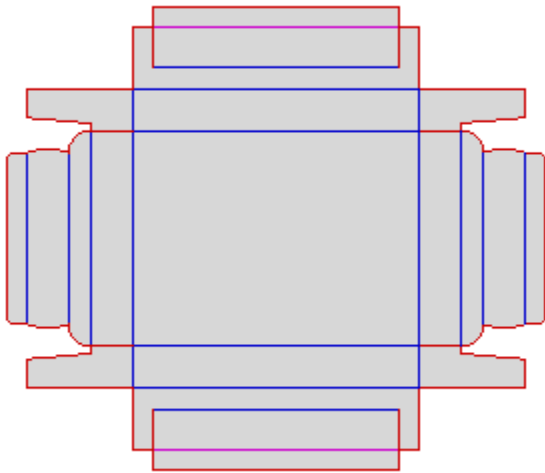

Glued Trays

LT050500

Straight line

Compact & E flute

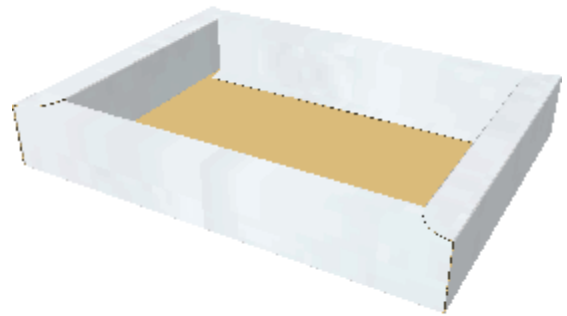
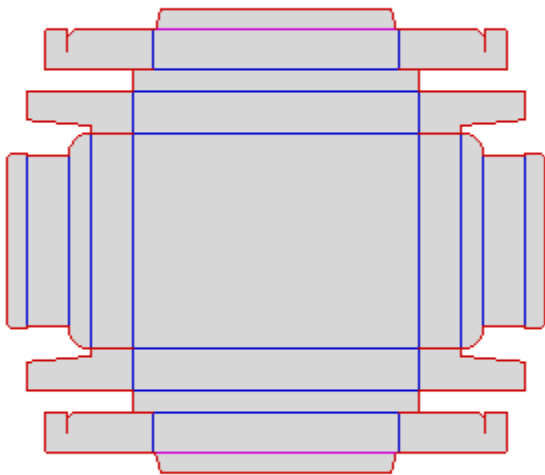

Glued Trays

LT050510

Straight line

Compact & E flute

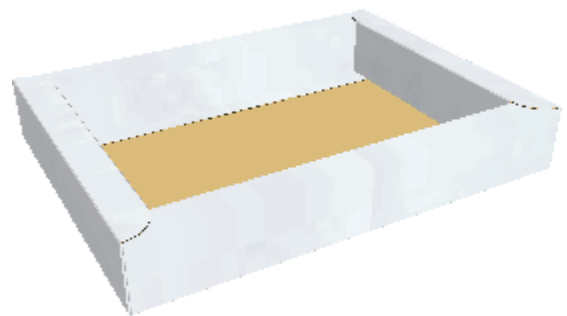
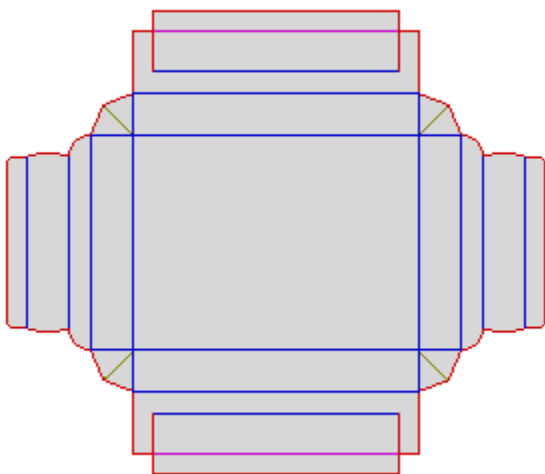

Glued Trays

LT050501

Straight line

Compact & E flute

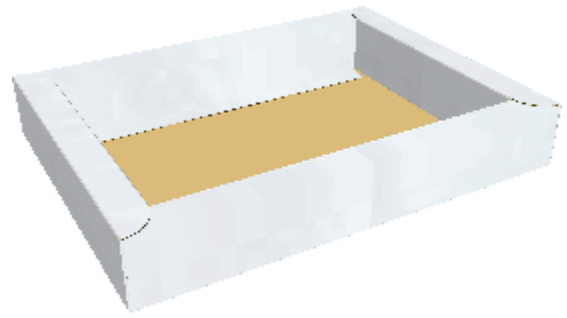
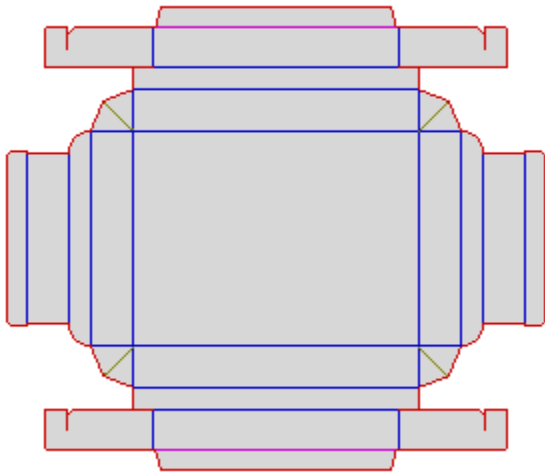

Glued Trays

LT050511

Straight line

Compact & E flute

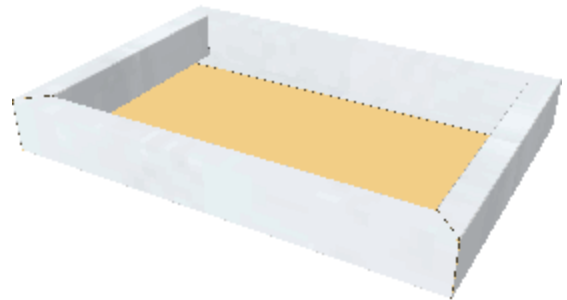
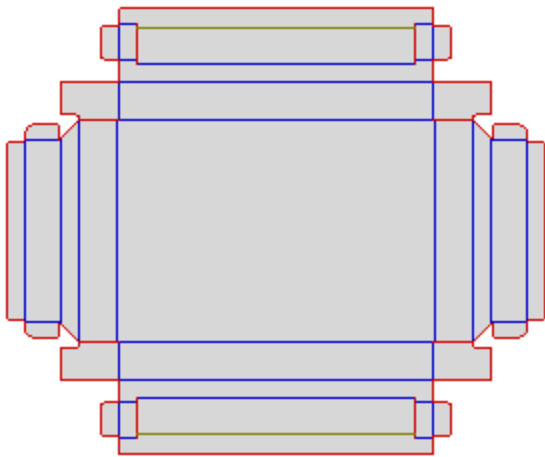

Glued Trays

LT050520

Straight line

Compact & E flute

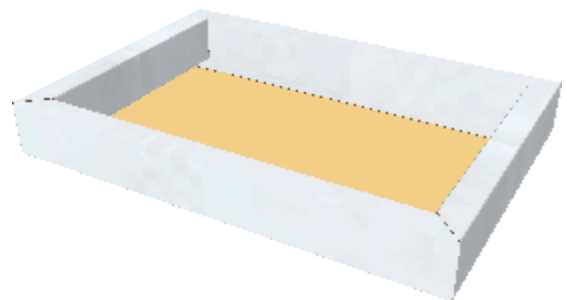
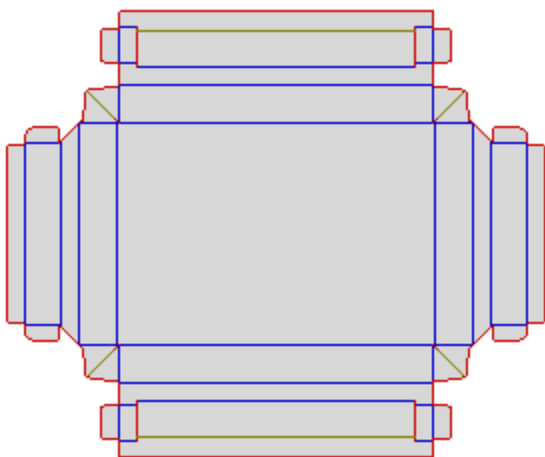

Glued Trays

LT050521

Straight line

Compact & E flute

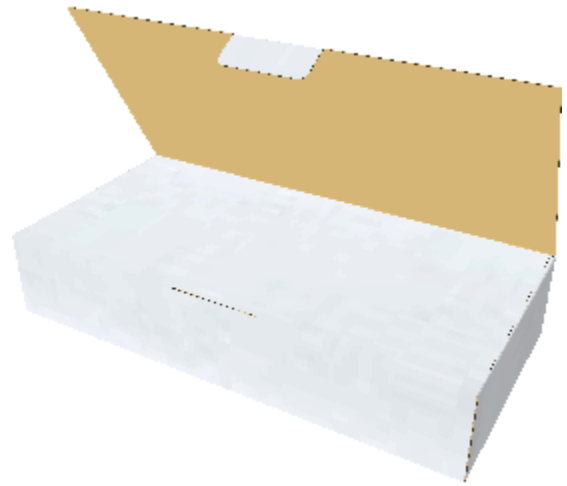
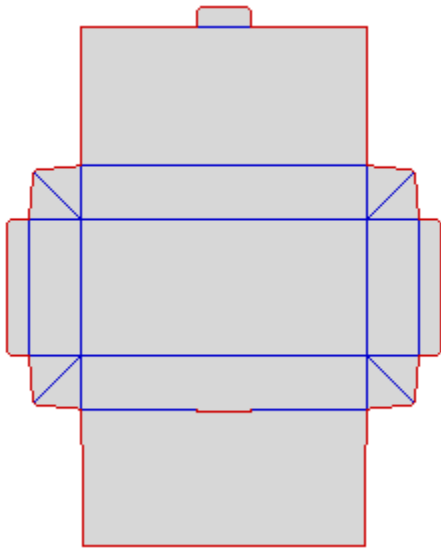

Glued Trays

LT051301

4 Corners

Compact & E flute

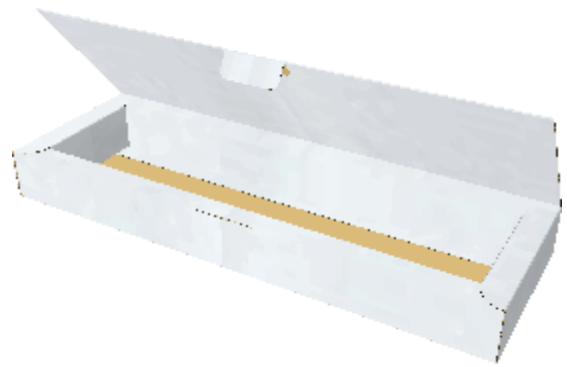
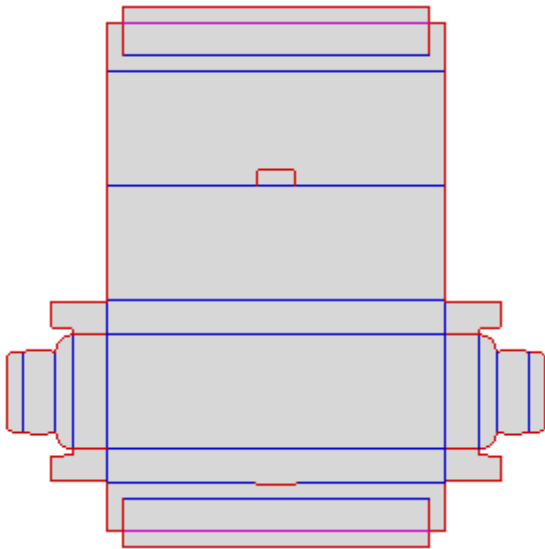

Glued Trays

LT051500

Straight line

Compact & E flute

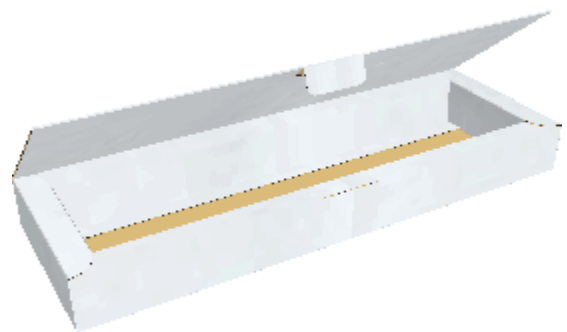
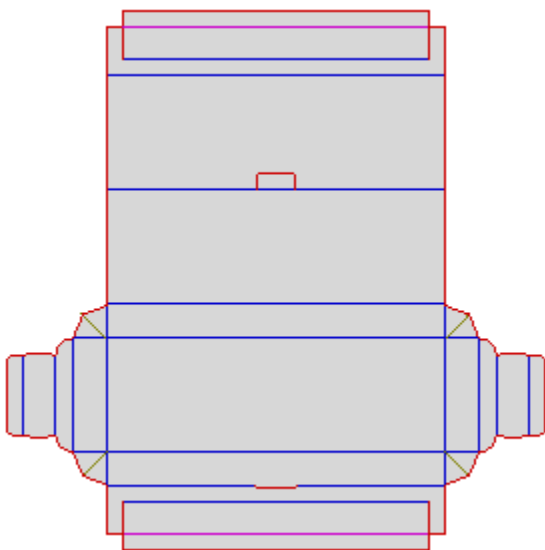

Glued Trays

LT051501

Straight line

Compact & E flute

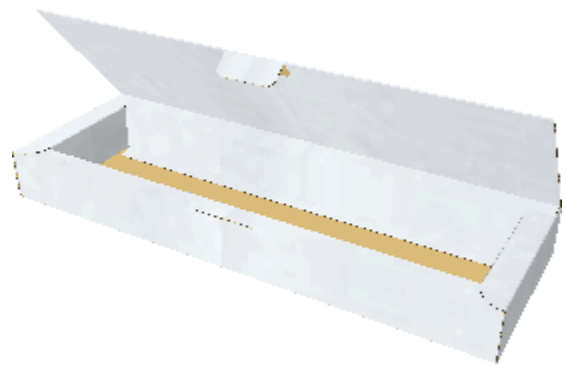
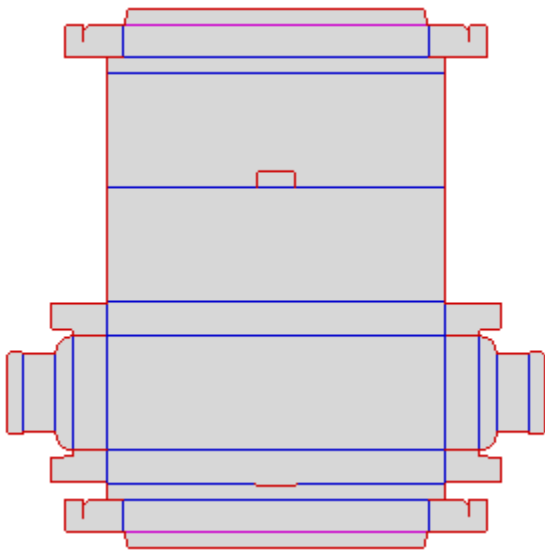

Glued Trays

LT051510

Straight line

Compact & E flute

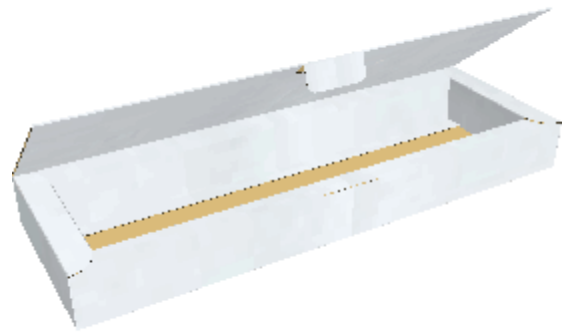
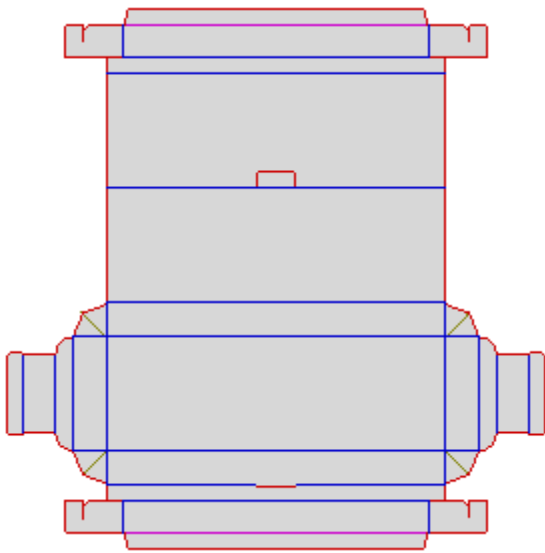

Glued Trays

LT051511

Straight line

Compact & E flute

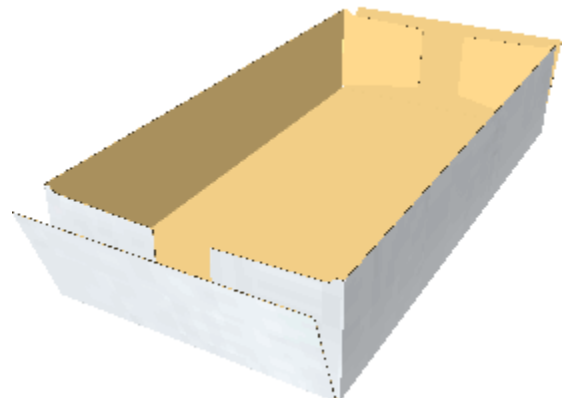
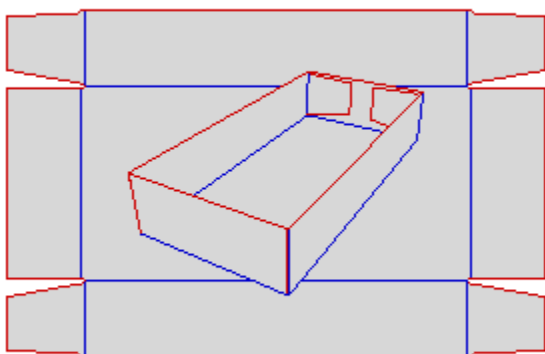

Glued Trays

LT050600_01

Packers

Compact & E flute

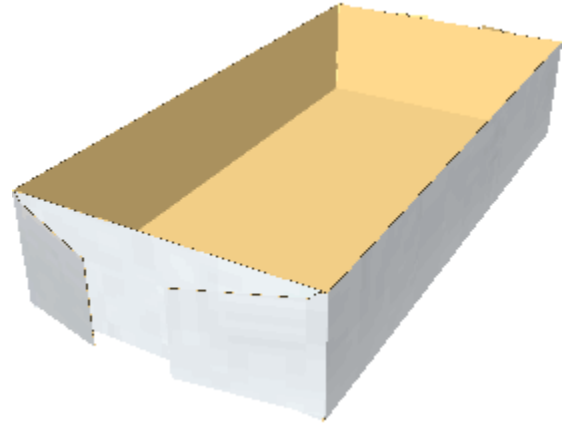
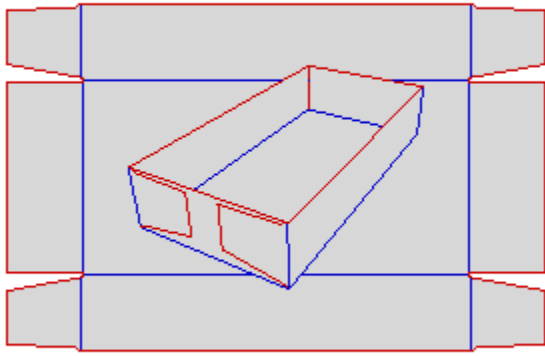

Glued Trays

LT050601

Packers

Compact & E flute

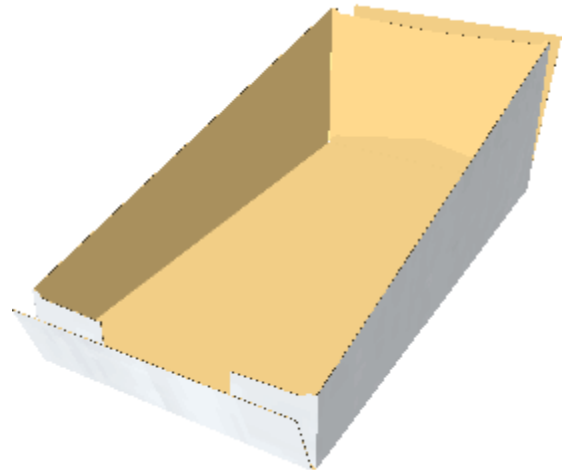
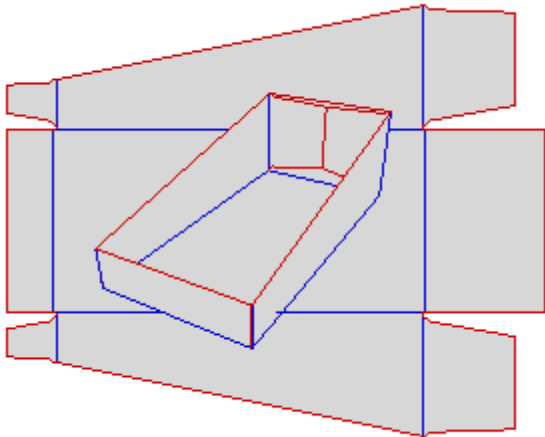

Glued Trays

LT050610_01

Packers

Compact & E flute

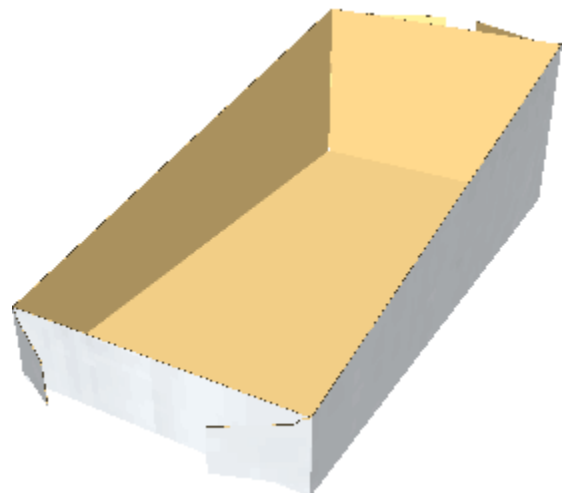
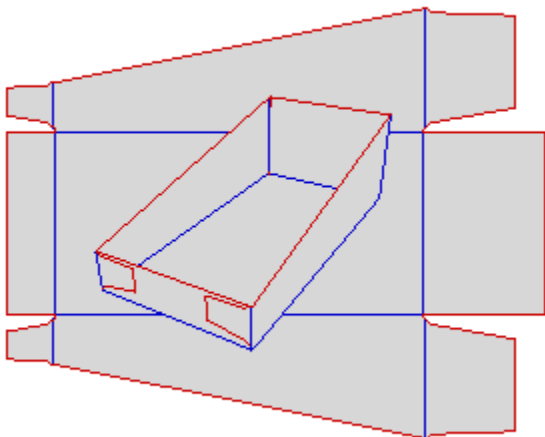

Glued Trays

LT050611

Packers

Compact & E flute

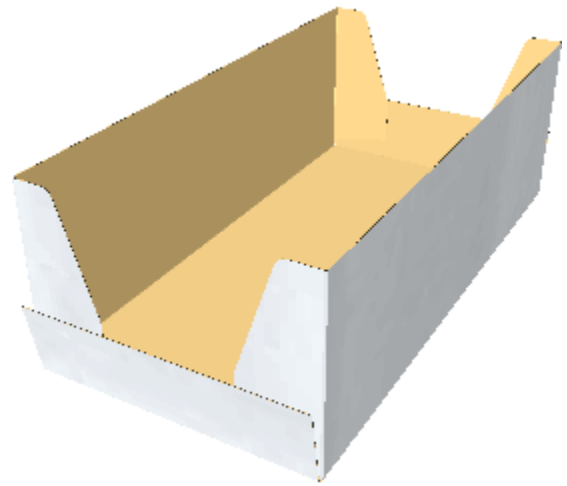
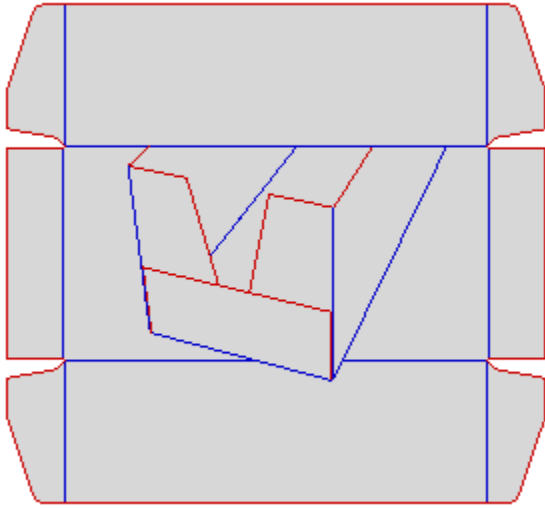

Glued Trays

LT050620_01

Packers

Compact & E flute

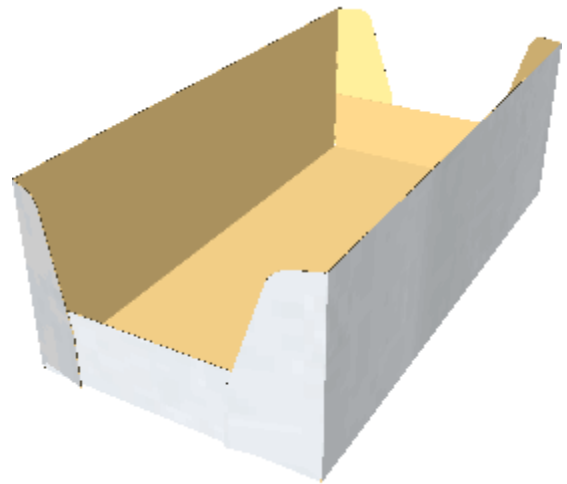
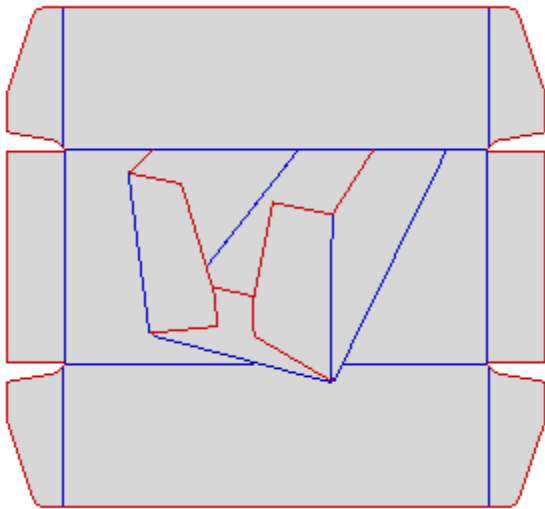

Glued Trays

LT050621

Packers

Compact & E flute

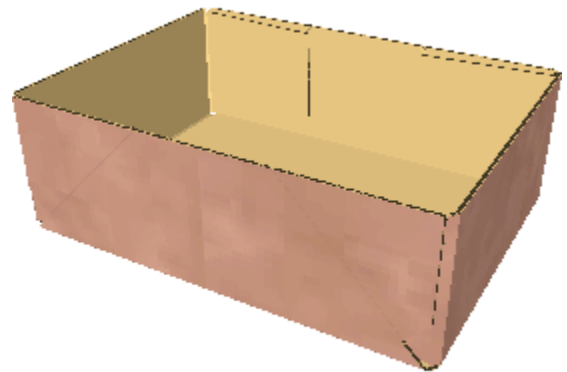
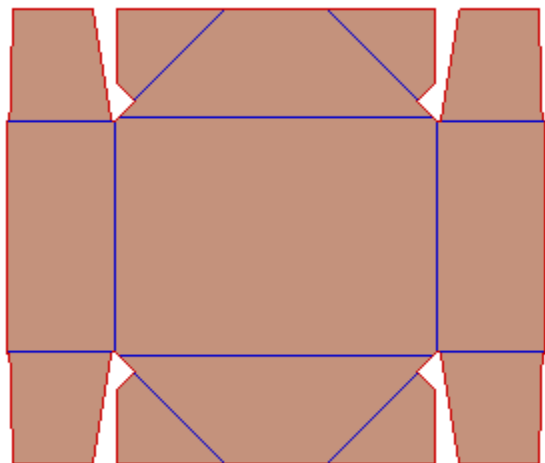

Glued Trays

OT050301

4 Corners

Corrugated

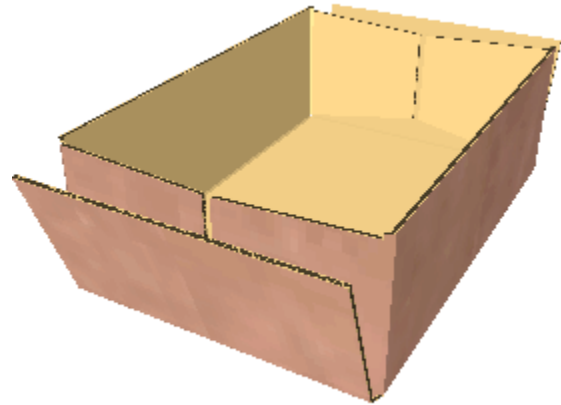
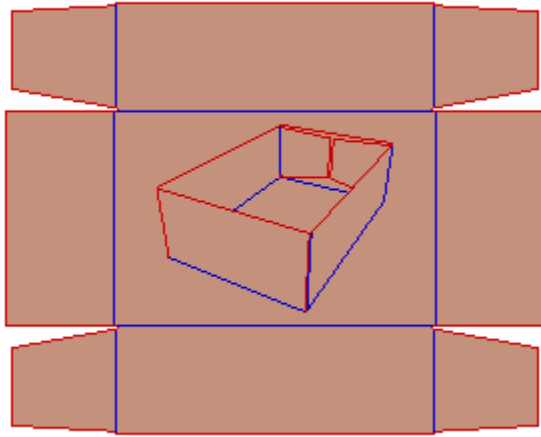

Glued Trays

OT050600

Packers

Corrugated

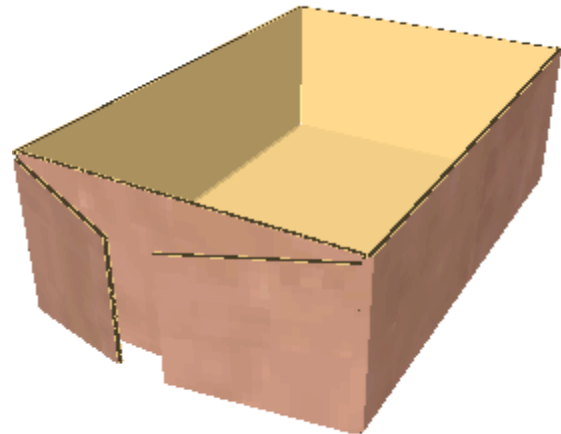
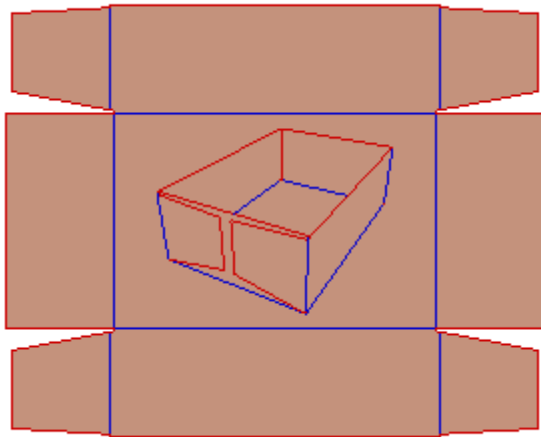

Glued Trays

OT050601

Packers

Corrugated

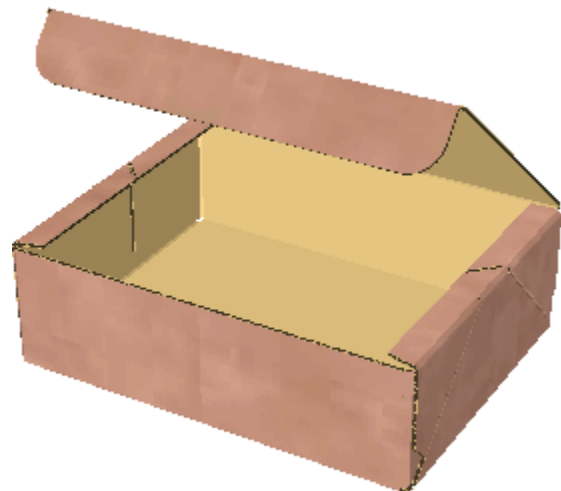
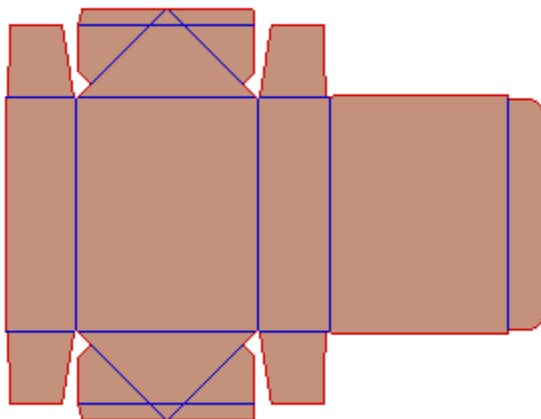

Glued Trays

OT050311

4 Corners

Corrugated

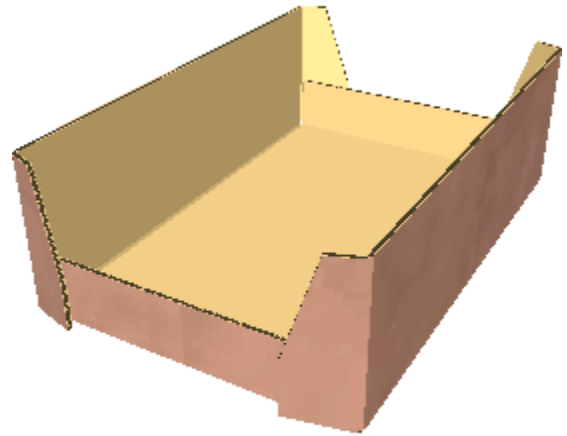
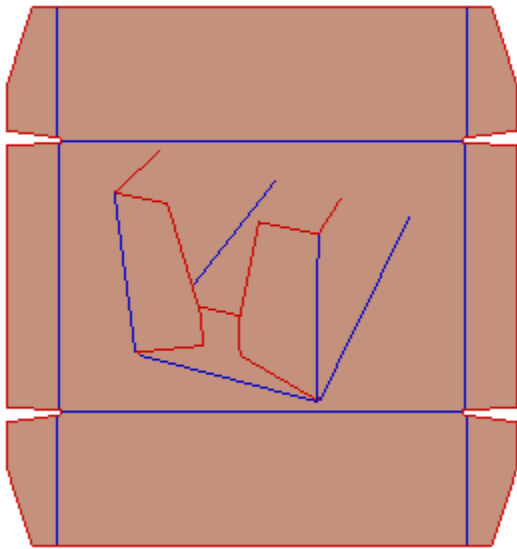

Glued Trays

OT050611_01

Packers

Corrugated

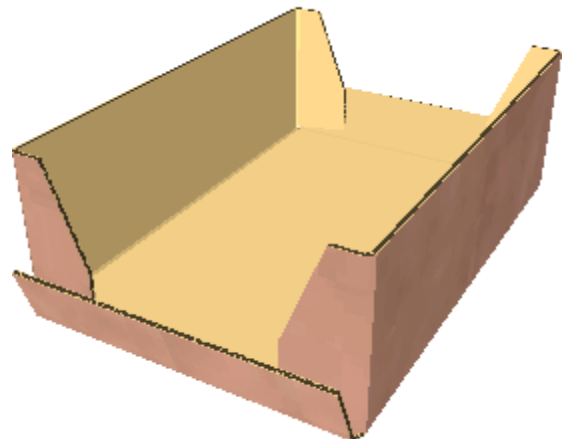
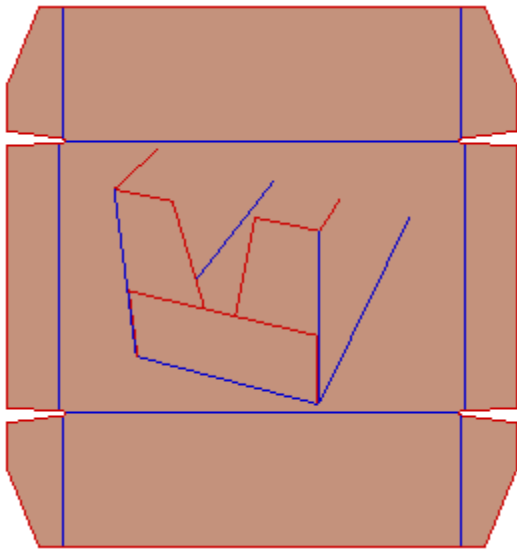

Glued Trays

OT050613

Packers

Corrugated

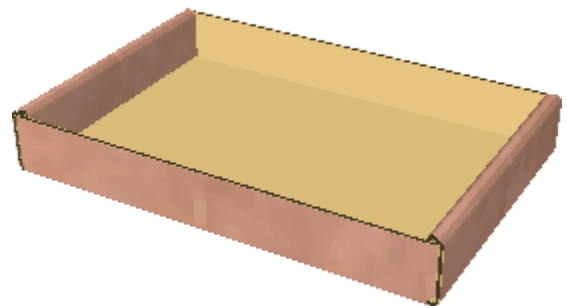

Glued Trays

OT050630

Packers

Corrugated

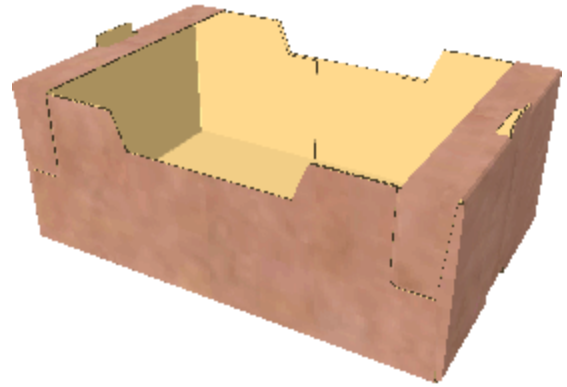
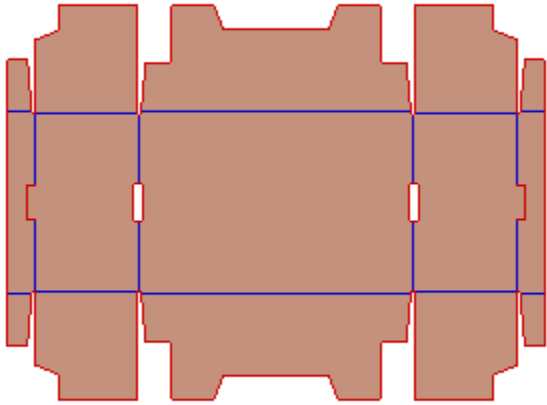

Glued Trays

OT050800

Packers

Corrugated

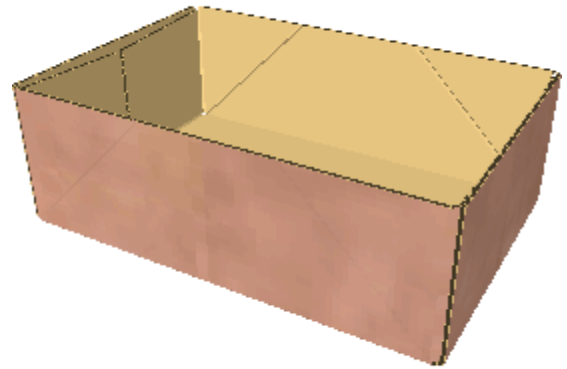
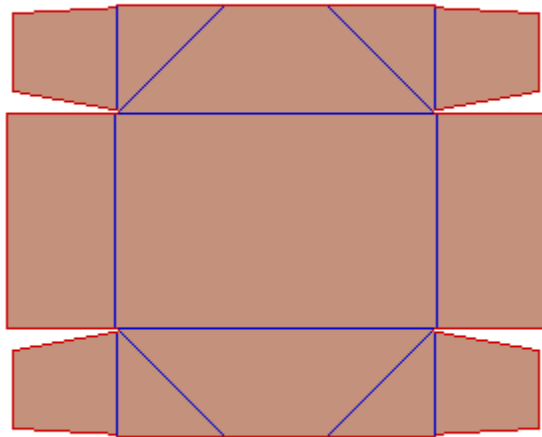

Glued Trays

OT050303

4 Corners

Corrugated

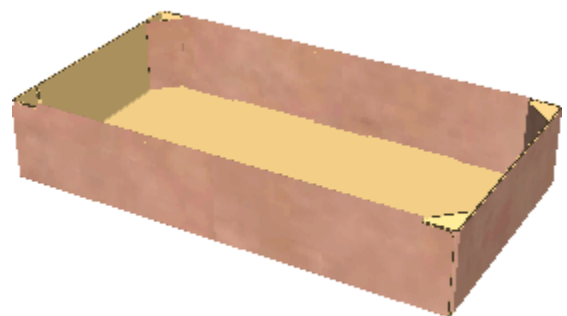
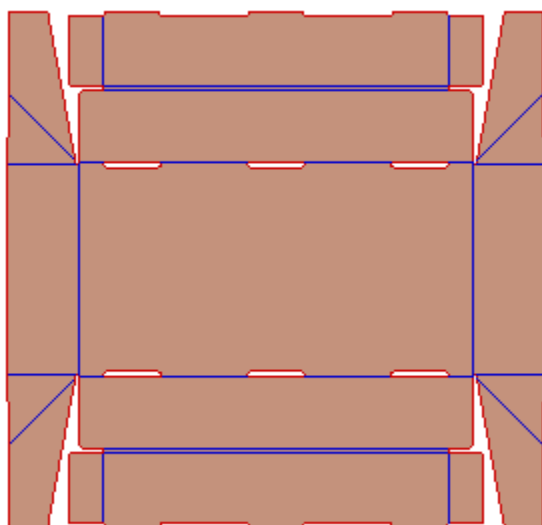

Glued Trays

OT050700_01

4 Corners

Corrugated

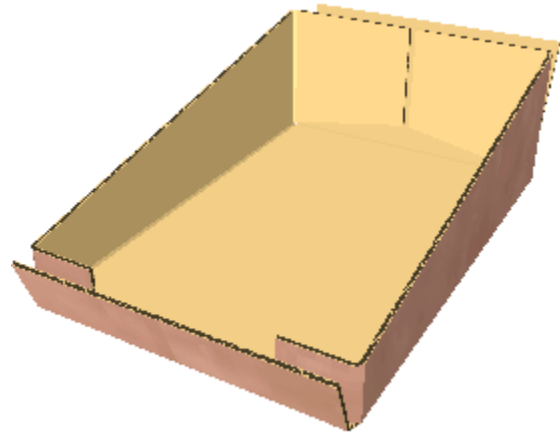
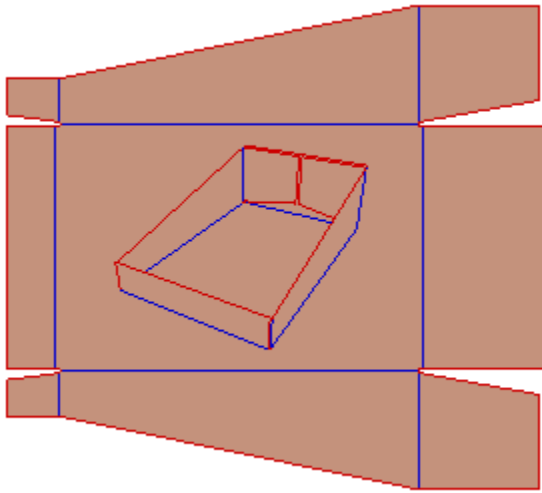

Glued Trays

OT050610

Packers

Corrugated

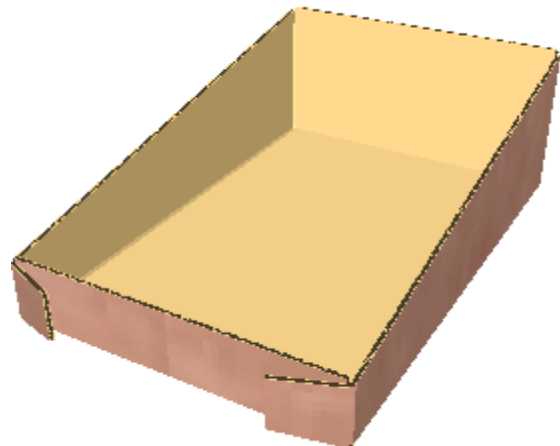
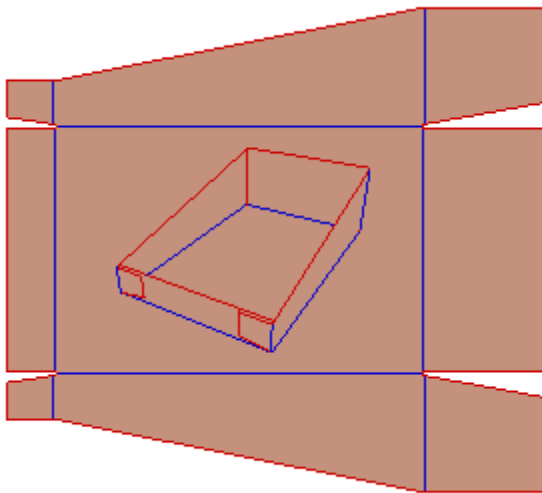

Glued Trays

OT050612

Packers

Corrugated

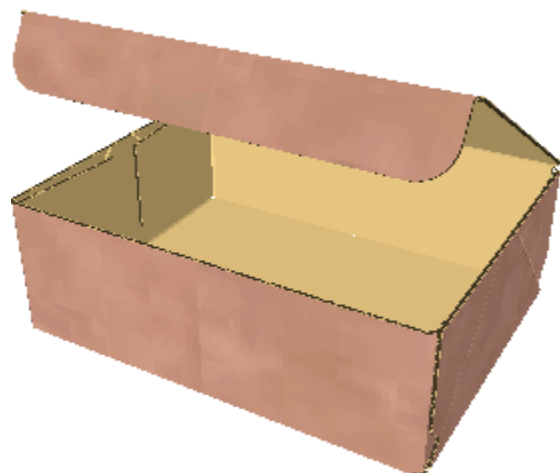
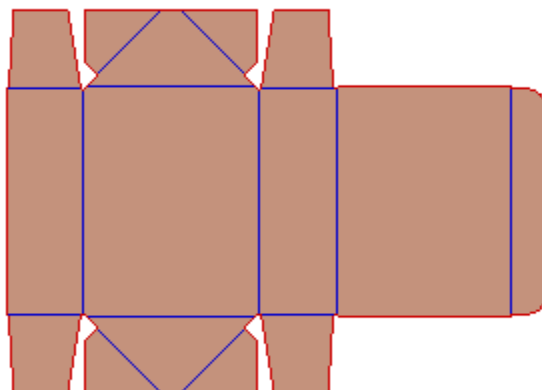

Glued Trays

OT050310

4 Corners

Corrugated

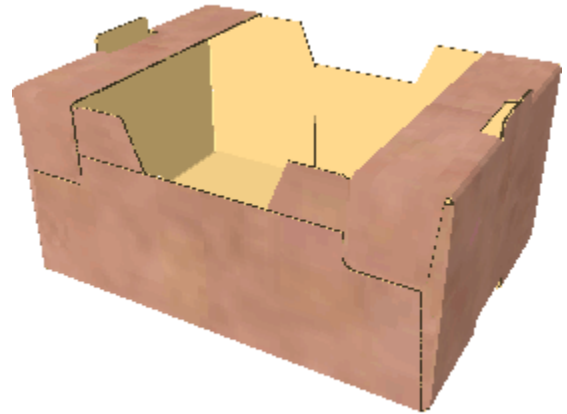
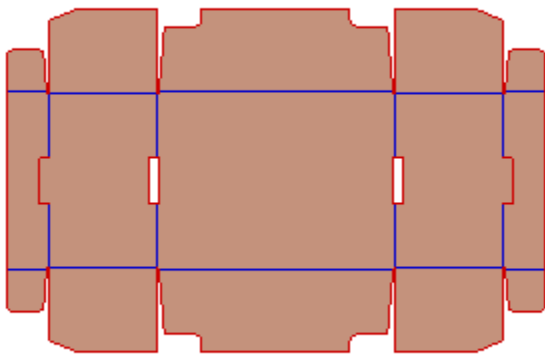

Glued Trays

OT050801

Packers

Corrugated

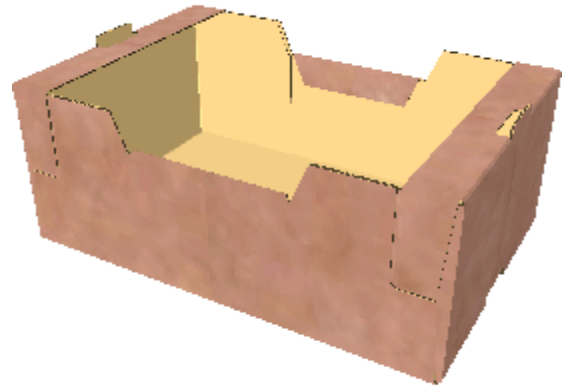
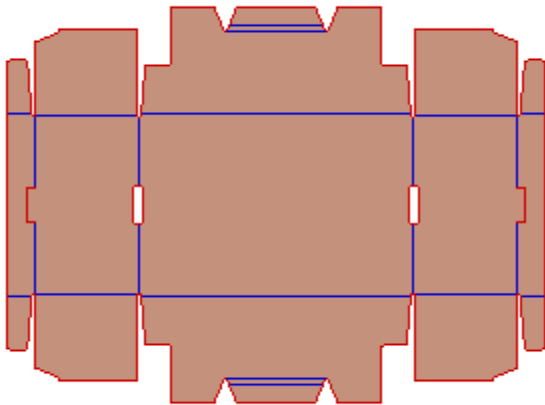

Glued Trays

OT050802

Packers

Corrugated

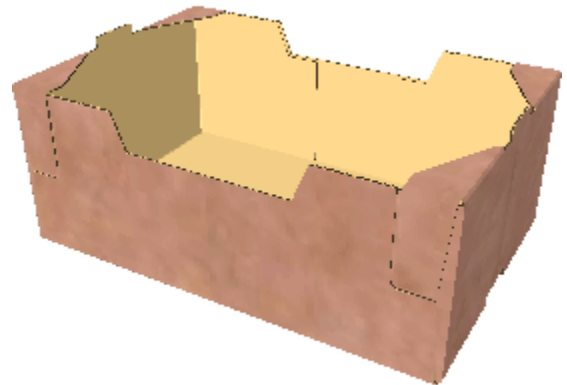
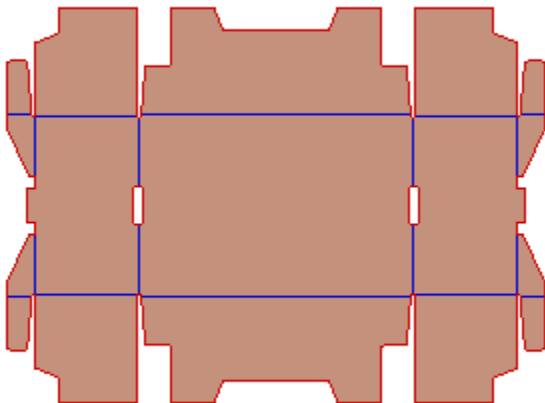

Glued Trays

OT050803

Packers

Corrugated

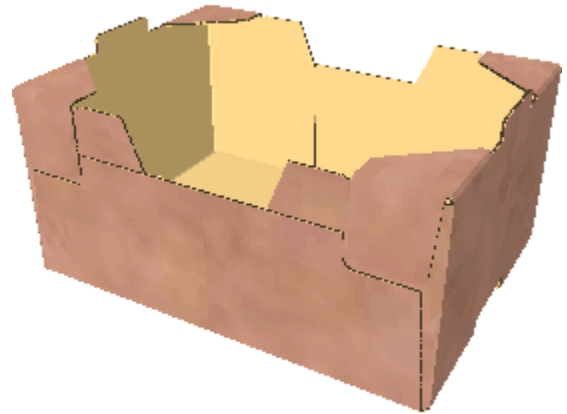
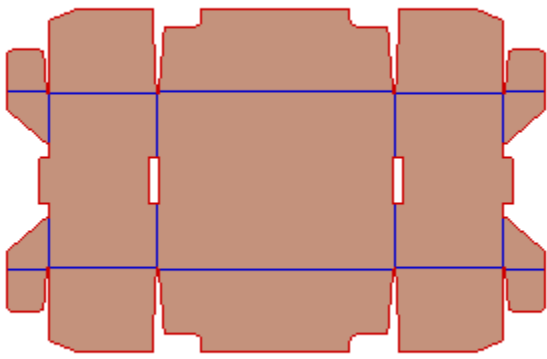

Glued Trays

OT050804

Packers

Corrugated

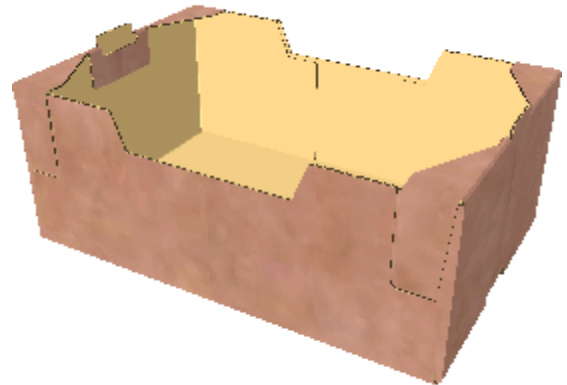
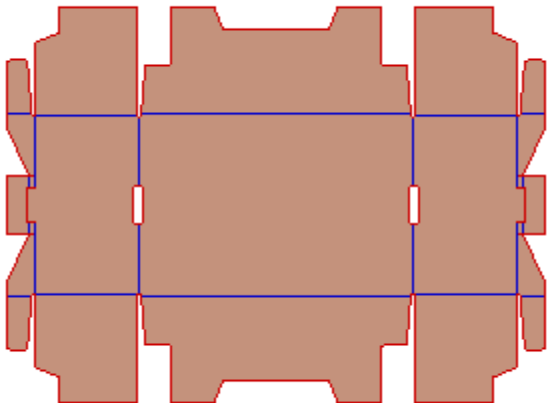

Glued Trays

OT050805

Packers

Corrugated

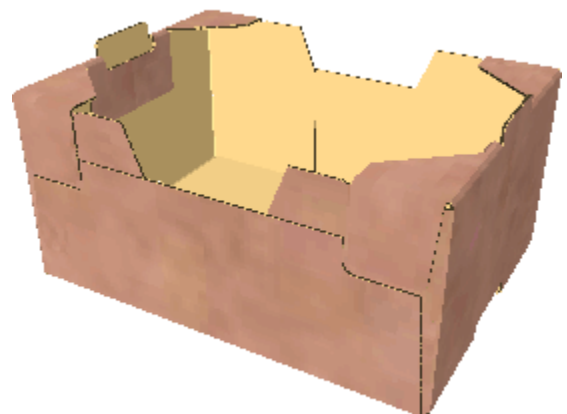
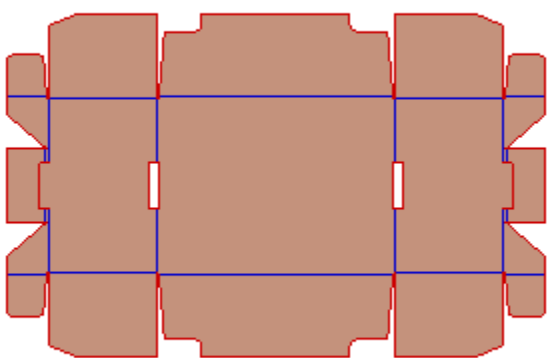

Glued Trays

OT050806

Packers

Corrugated

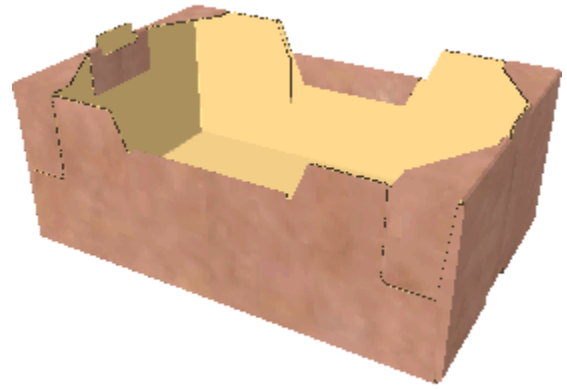
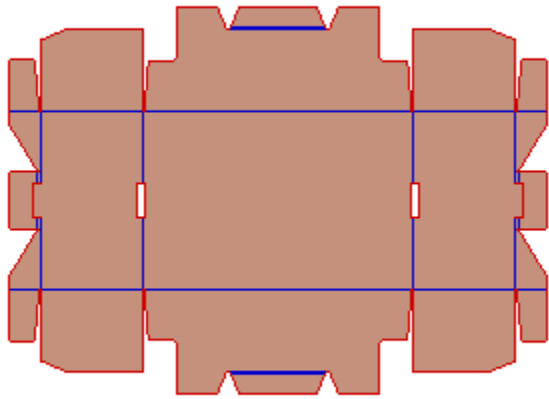

Glued Trays

OT050807

Packers

Corrugated

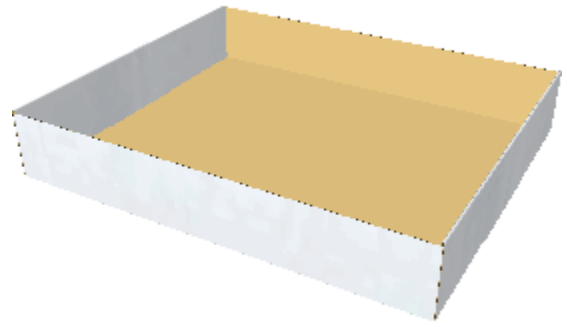
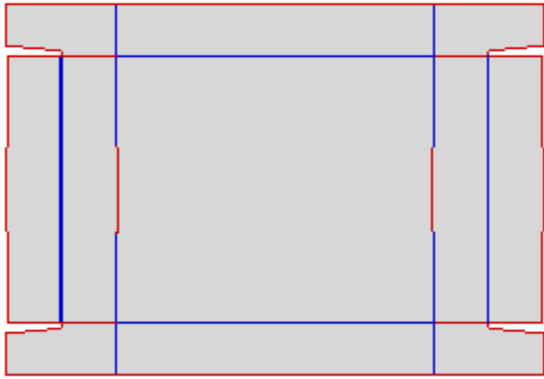

Self-Locking Trays

LT060101

Glue free

Compact & E flute

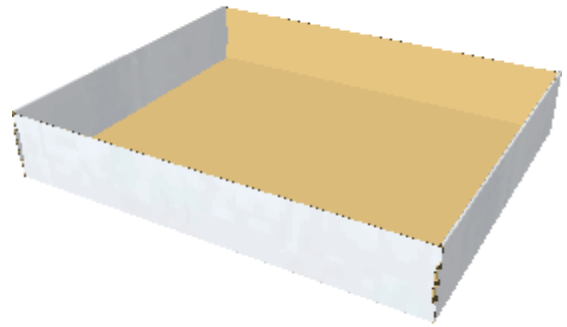
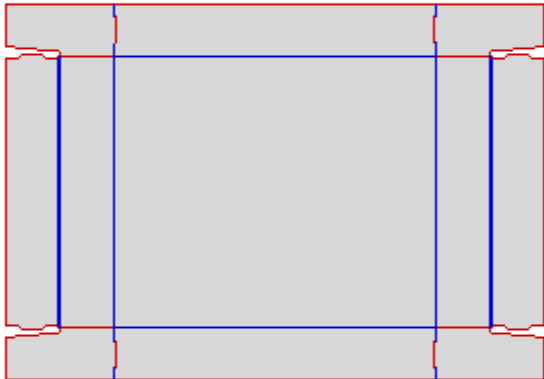

Self-Locking Trays

LT060102

Glue free

Compact & E flute

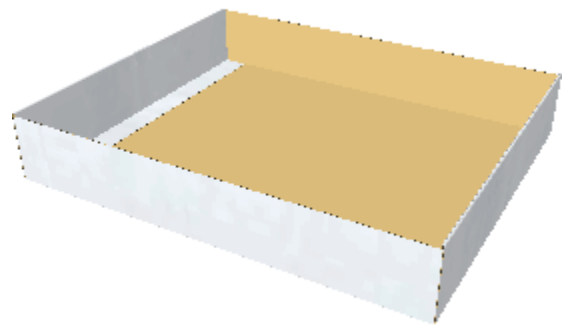
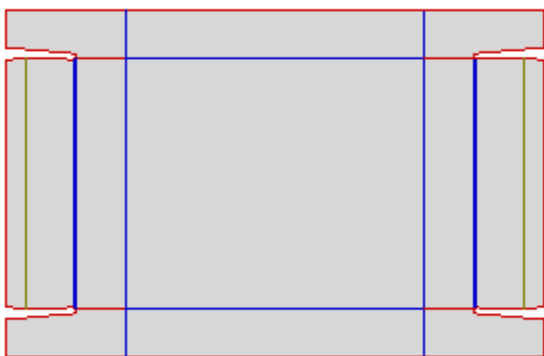

Self-Locking Trays

LT060103

Glue free

Compact & E flute

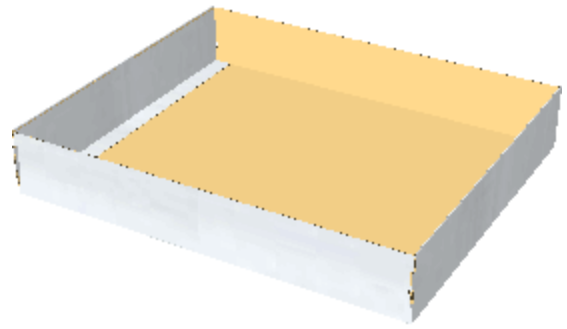
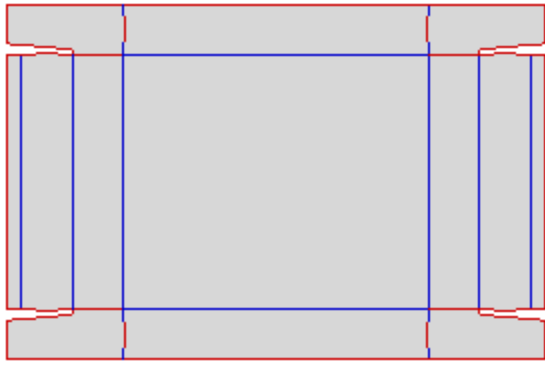

Self-Locking Trays

OT060105

Glue free

Compact & E flute

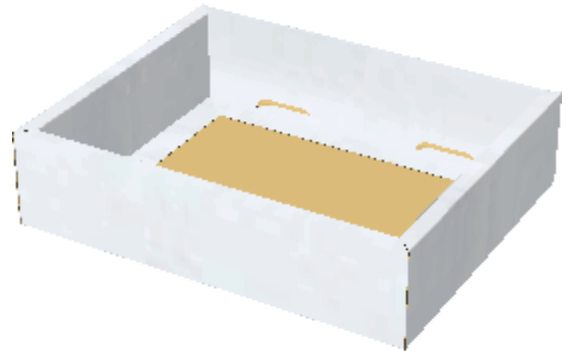
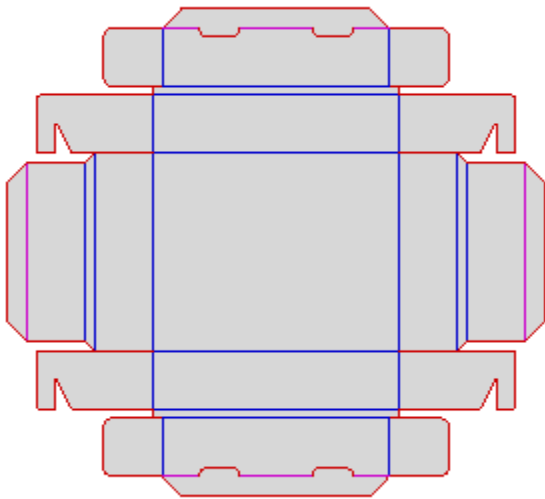

Self-Locking Trays

LT060104

Glue free

Compact & E flute

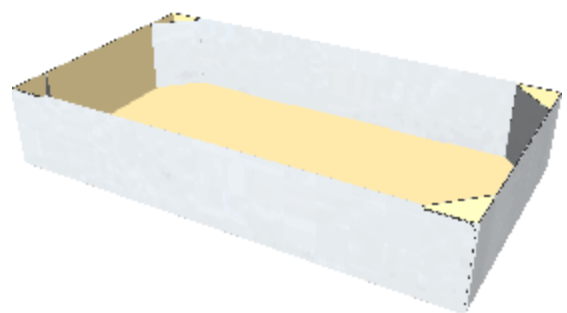
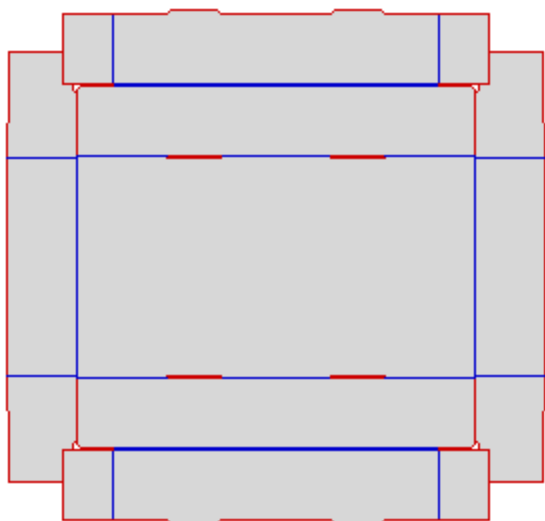

Self-Locking Trays

LT060120

Glue free

Compact & E flute

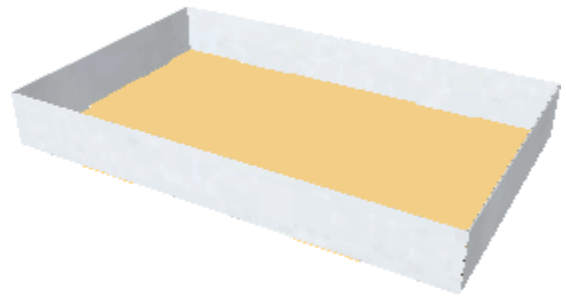
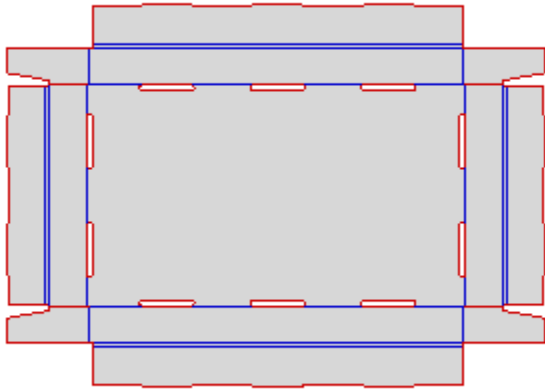

Self-Locking Trays

LT060130

Glue free

Compact & E flute

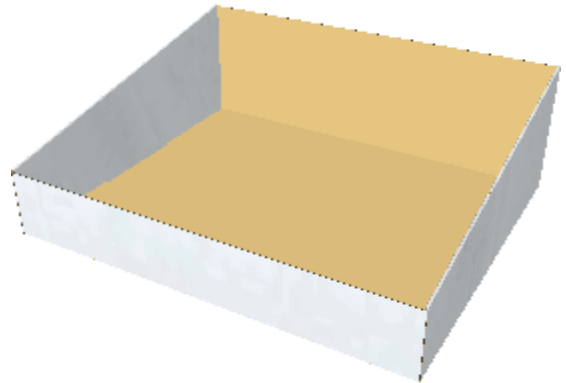
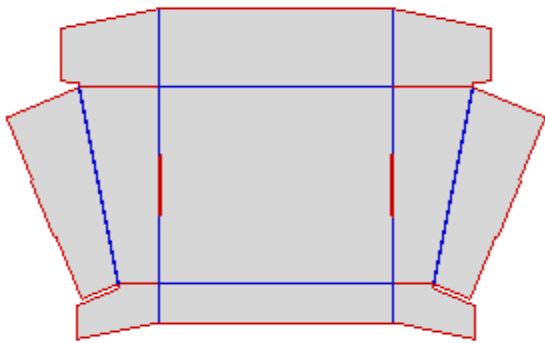

Self-Locking Trays

LT150101

Glue free

Compact & E flute

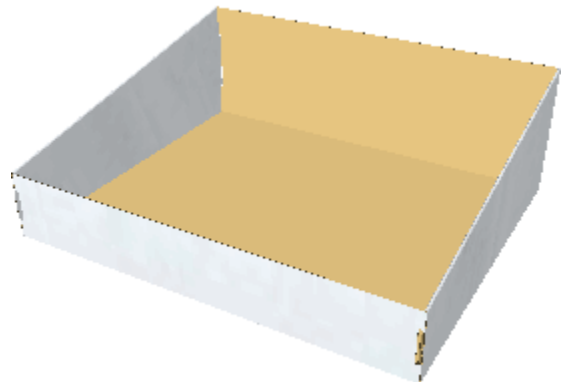
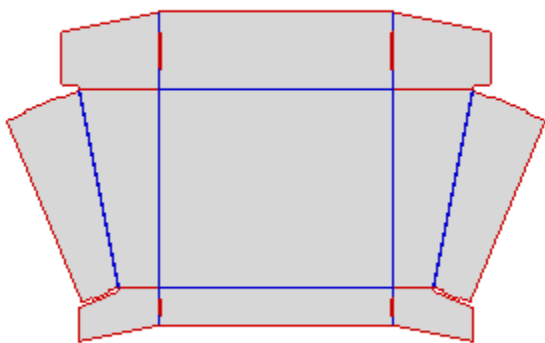

Self-Locking Trays

LT150102

Glue free

Compact & E flute

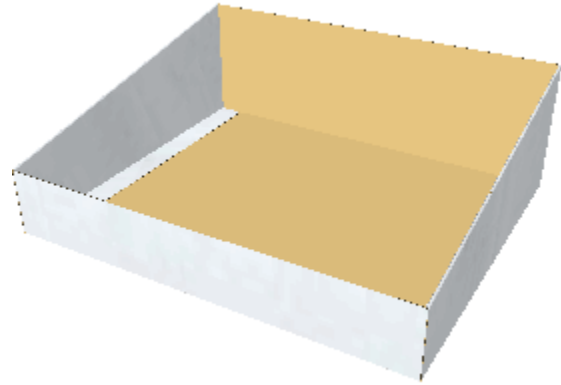
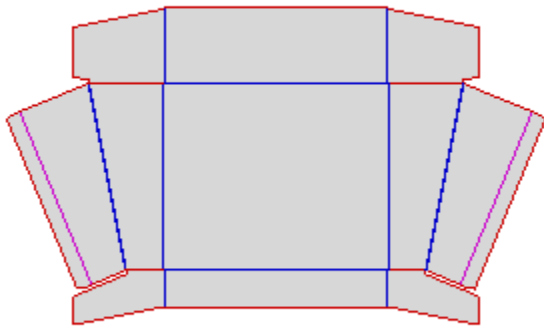

Self-Locking Trays

LT150103

Glue free

Compact & E flute

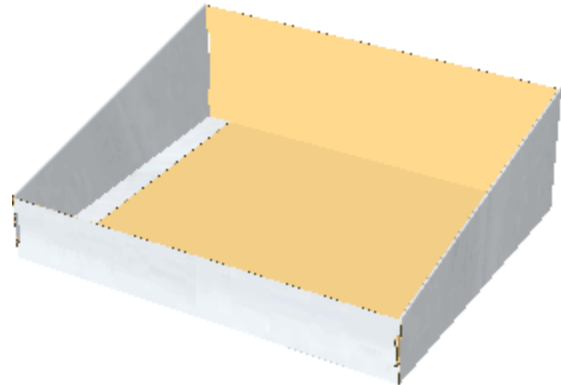
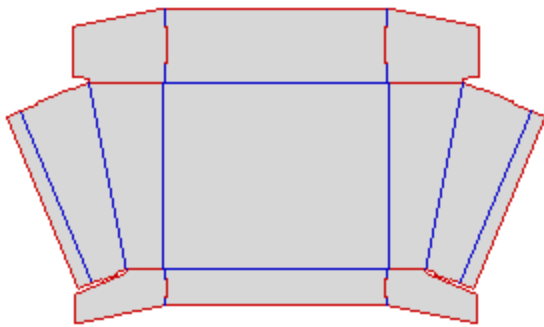

Self-Locking Trays

LT060110

Glue free

Compact & E flute

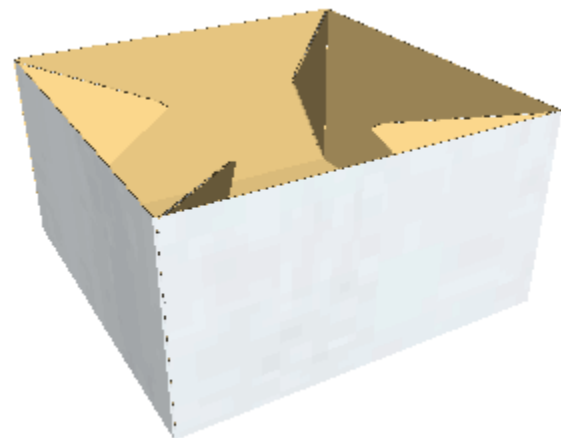
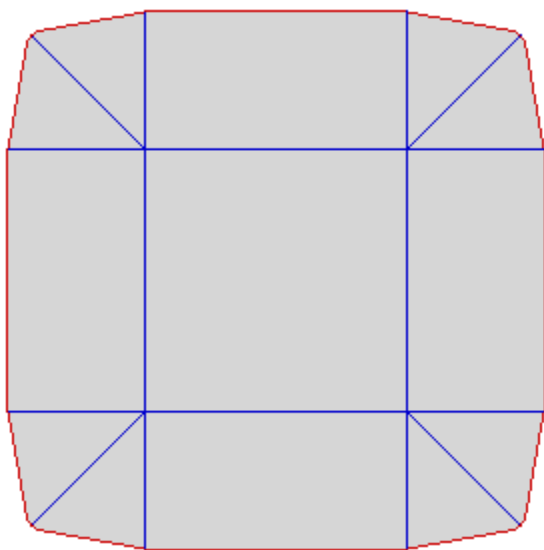

Self-Locking Trays

LT060001

Glue free

Compact & E flute

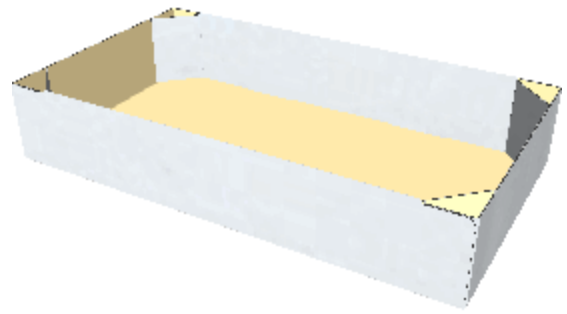
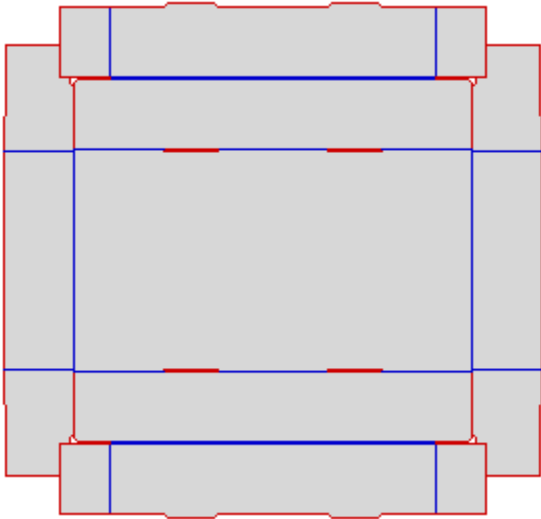

Self-Locking Trays

LT060120

Glue free

Compact & E flute

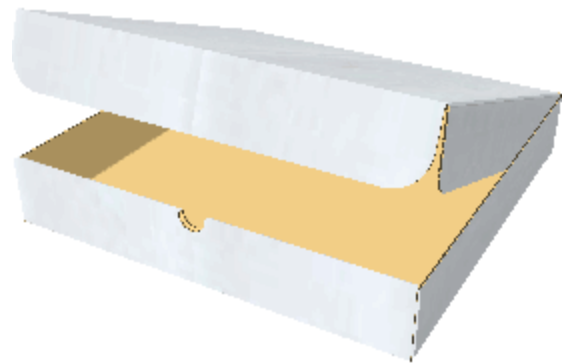
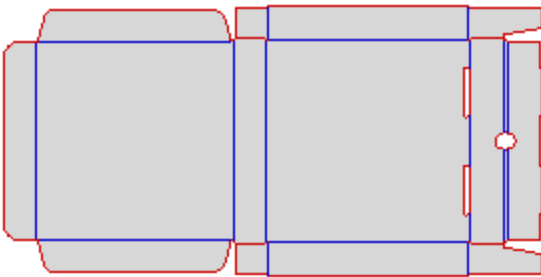

Self-Locking Trays

LT061120

Glue free

E flute

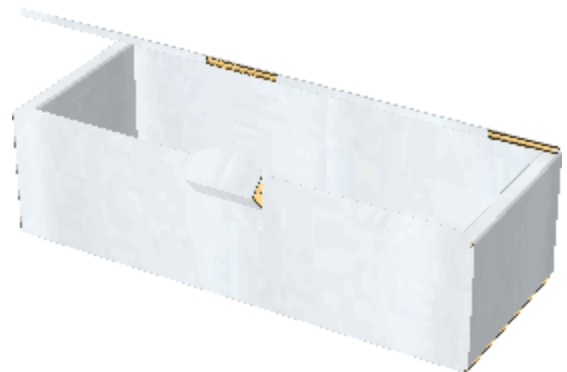
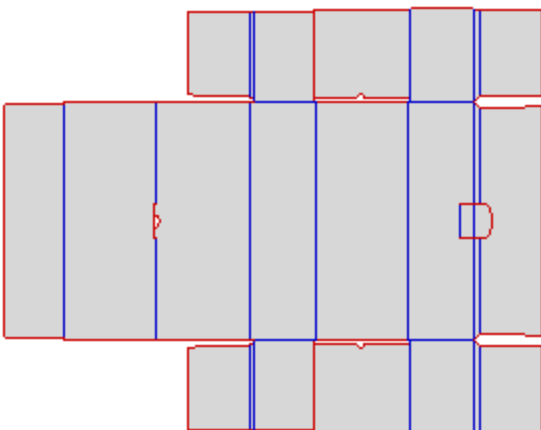

Self-Locking Trays

LT061400

Glue free

E flute

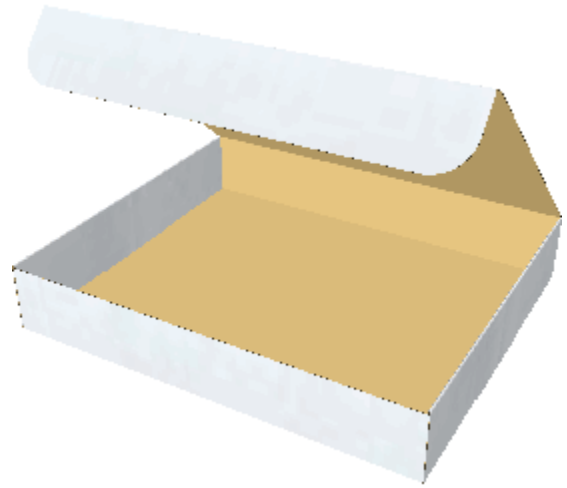
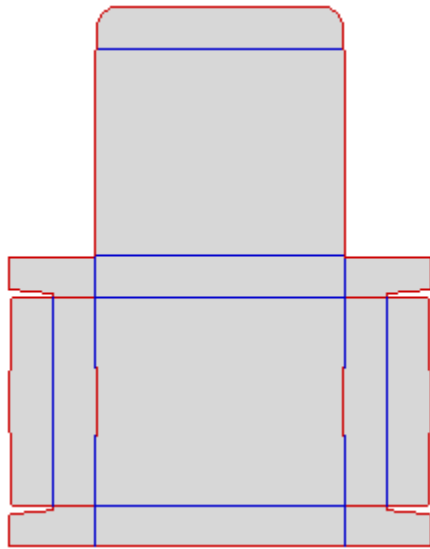

Self-Locking Trays

LT061101

Glue free

Compact & E flute

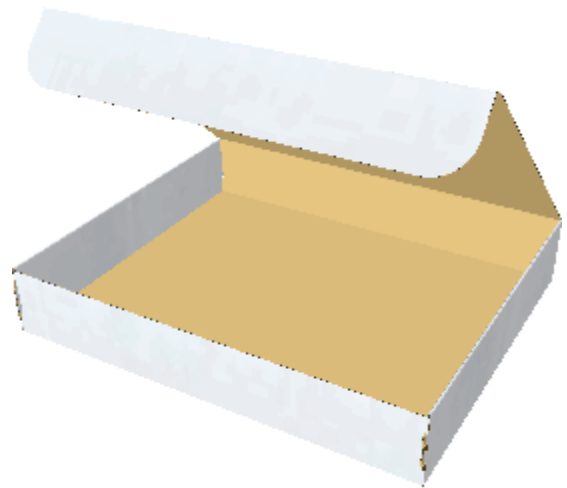
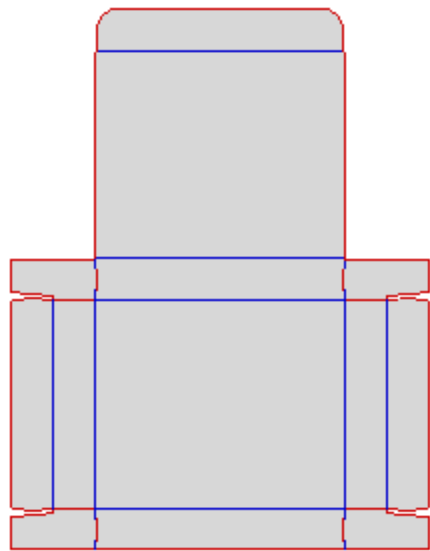

Self-Locking Trays

LT061102

Glue free

Compact & E flute

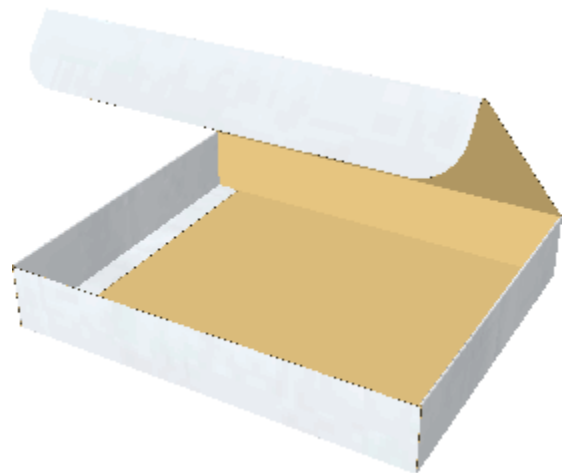
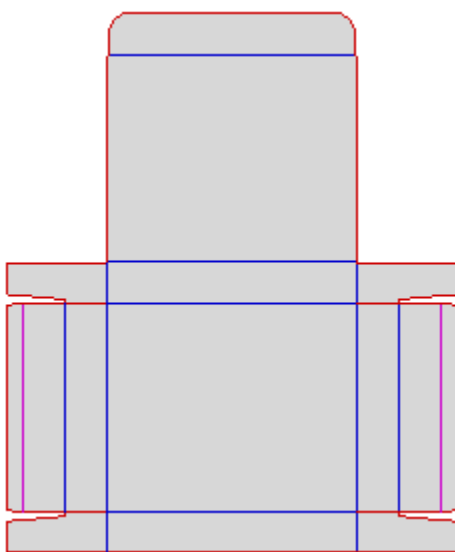

Self-Locking Trays

LT061103

Glue free

Compact & E flute

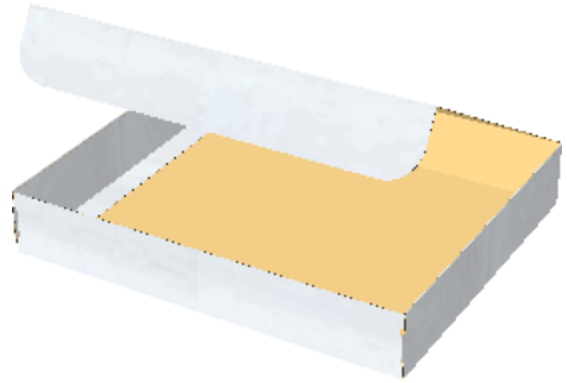
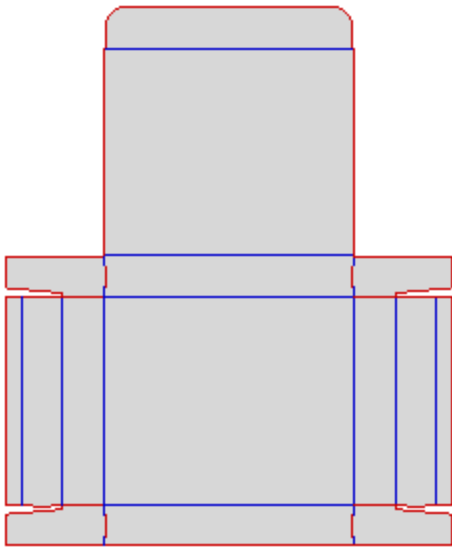

Self-Locking Trays

LT061106

Glue free

Compact & E flute

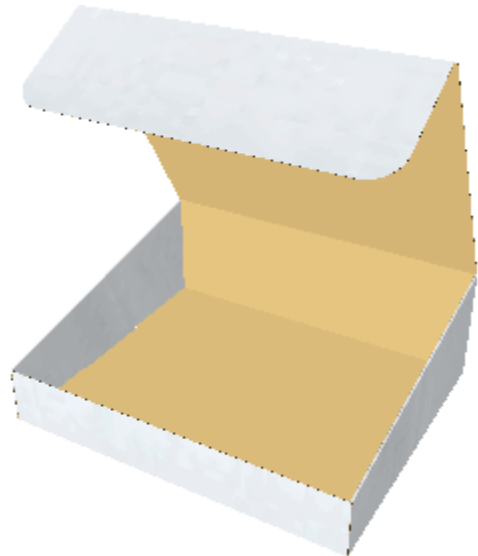
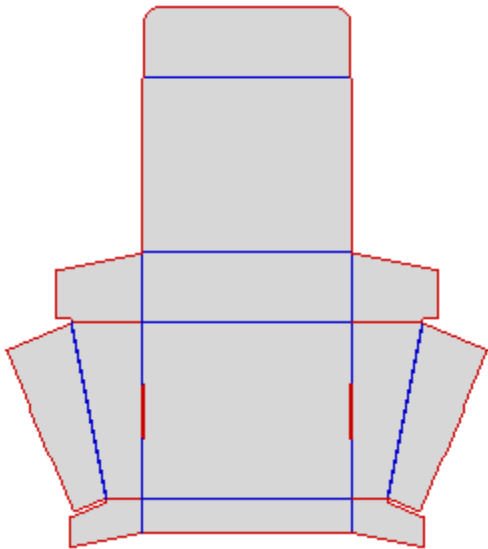

Self-Locking Trays

LT151101

Glue free

Compact & E flute

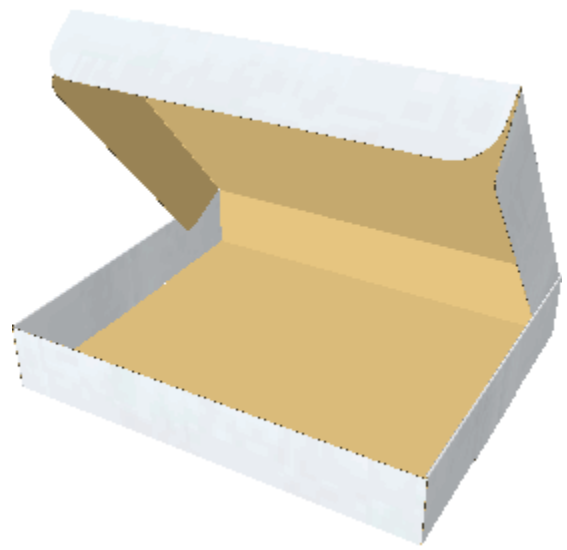
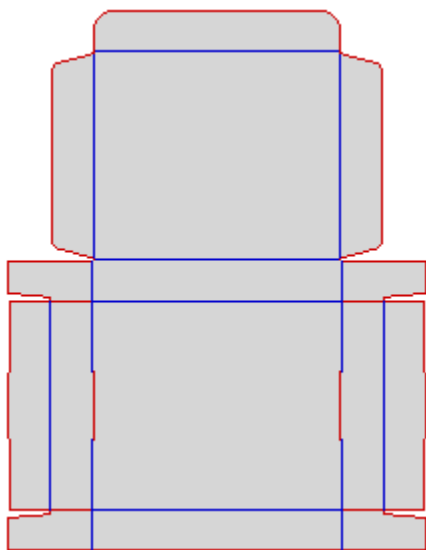

Self-Locking Trays

LT061104

Glue free

Compact & E flute

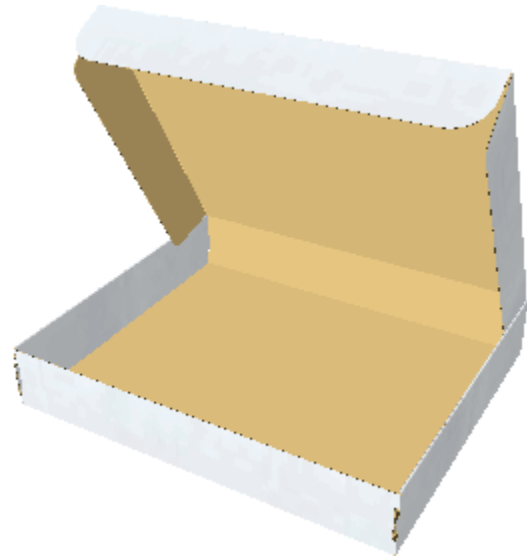
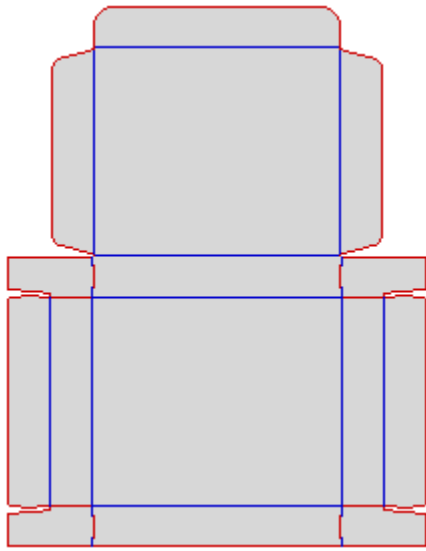

Self-Locking Trays

LT061105

Glue free

Compact & E flute

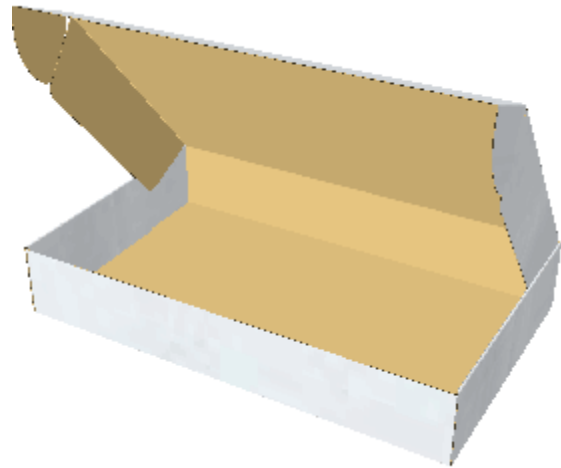
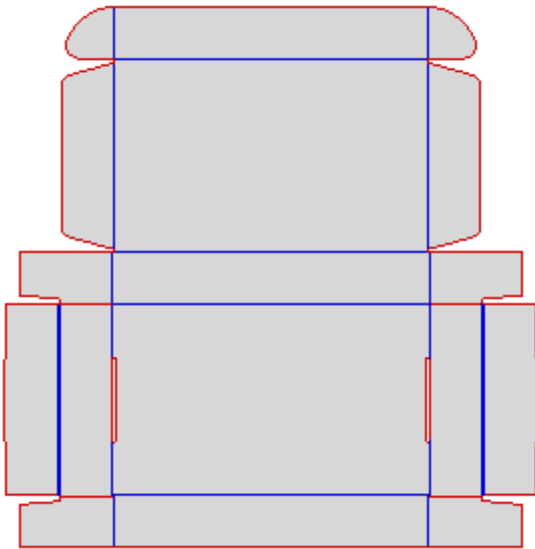

Self-Locking Trays

LT061110

Glue free

Compact & E flute

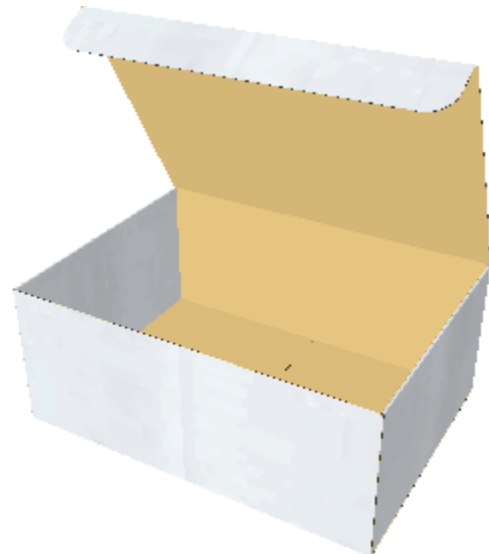
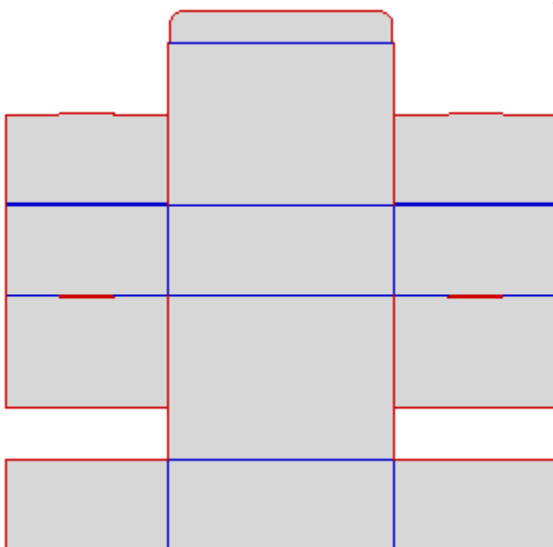

Self-Locking Trays

LT061140

Glue free

Compact & E flute

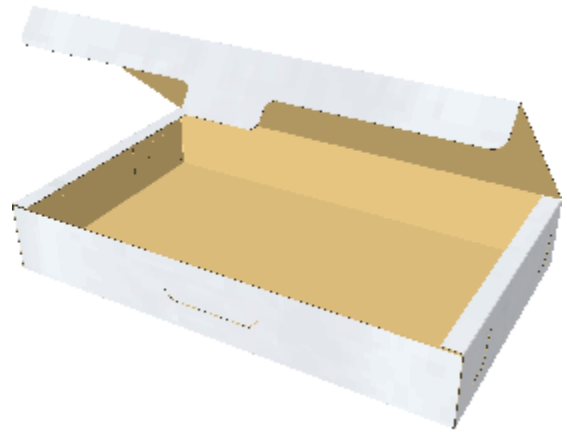
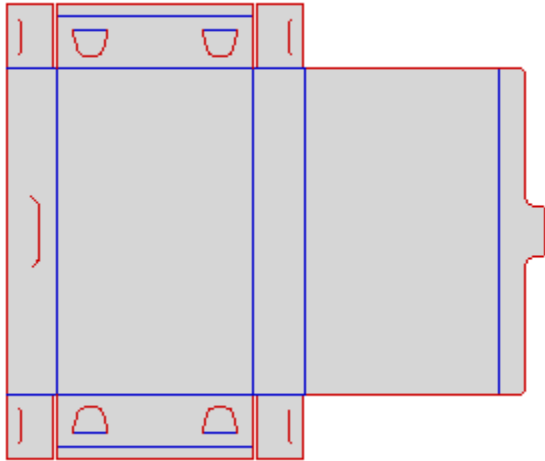

Self-Locking Trays

LT061001

Glue free

Compact & E flute

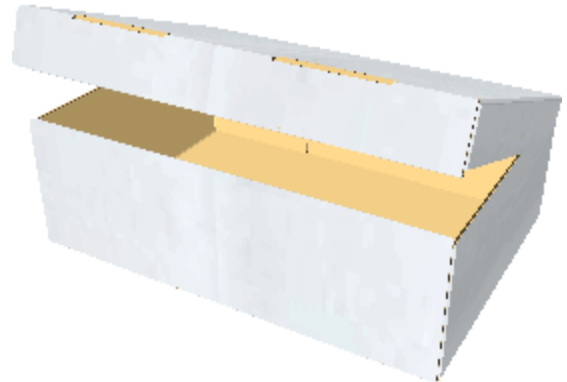
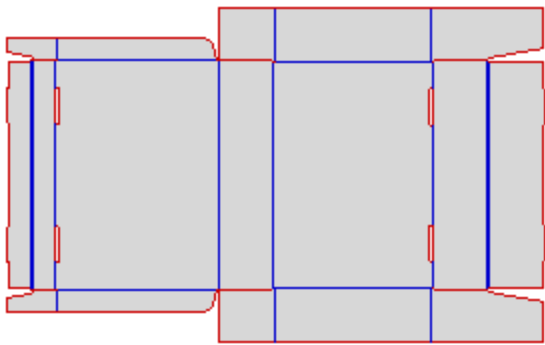

Self-Locking Trays

LT061121

Glue free

E flute

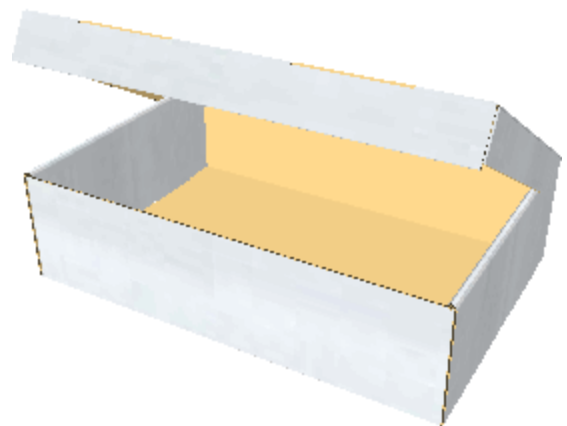
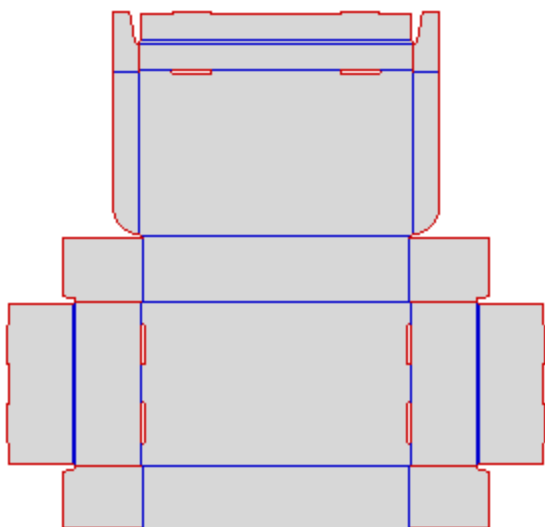

Self-Locking Trays

LT061130

Glue free

E flute

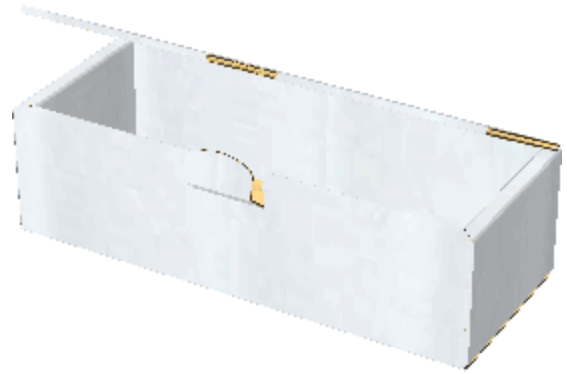
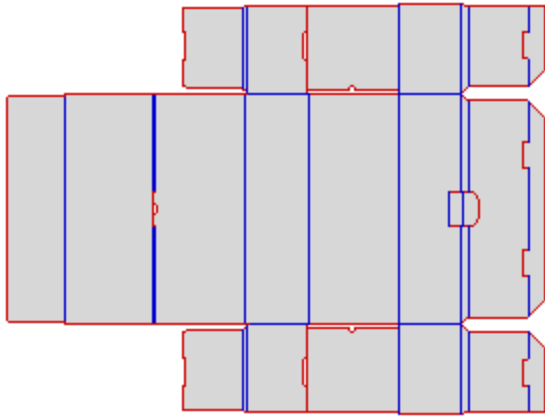

Self-Locking Trays

LT061401

Glue free

E flute

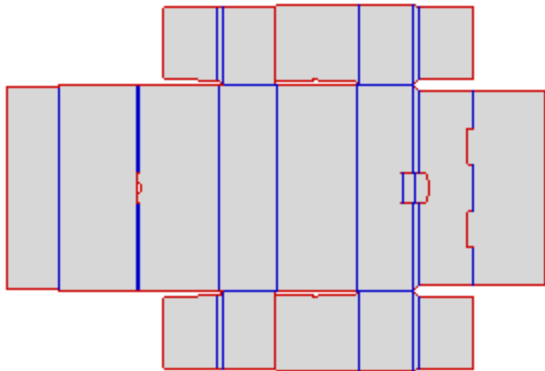

Self-Locking Trays

LT061402

Glue free

E flute

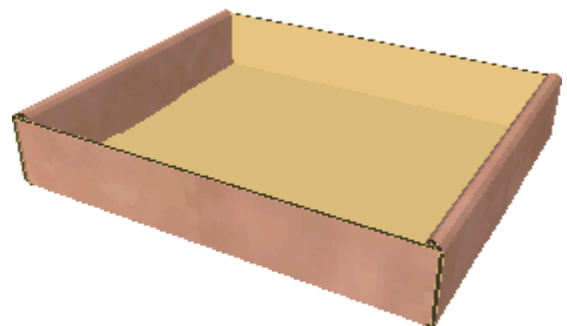
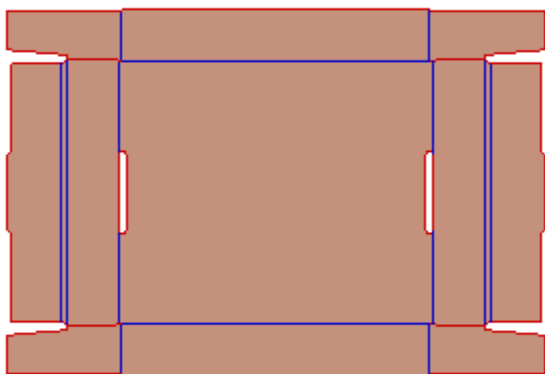

Self-Locking Trays

OT060101

Glue free

Corrugated

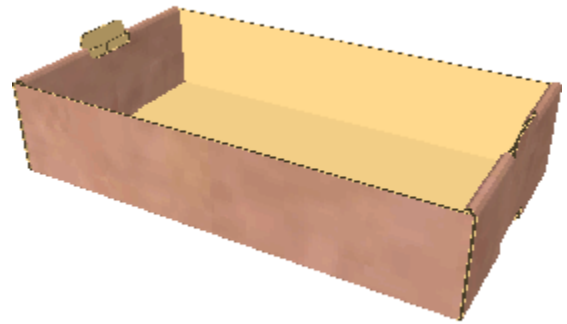
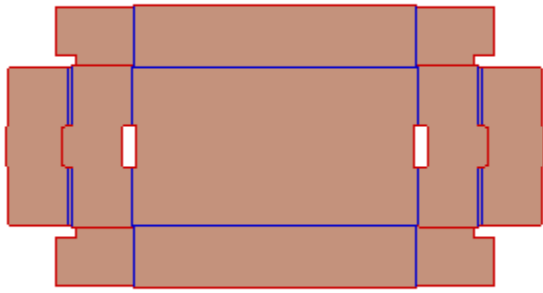

Self-Locking Trays

OT060140_01

Glue free

Corrugated

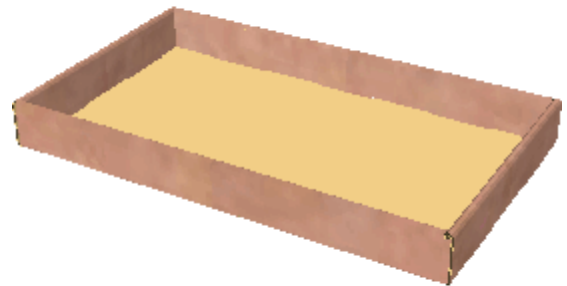
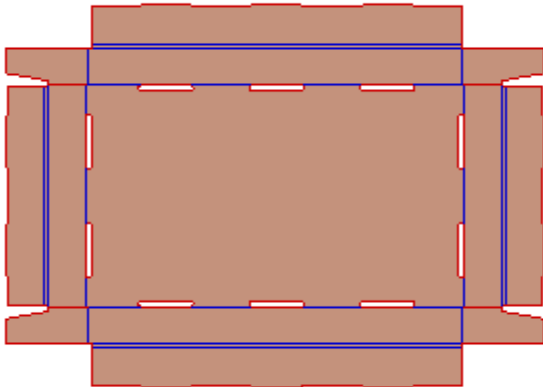

Self-Locking Trays

OT060130_01

Glue free

Corrugated

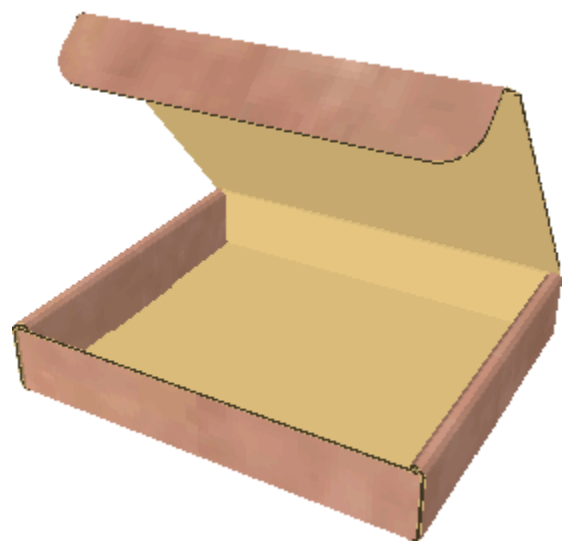
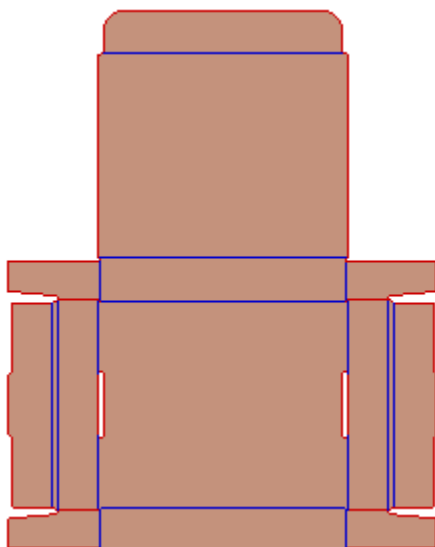

Self-Locking Trays

OT061101

Glue free

Corrugated

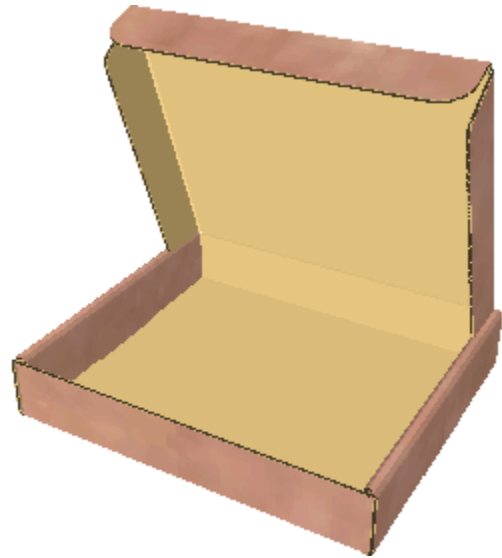
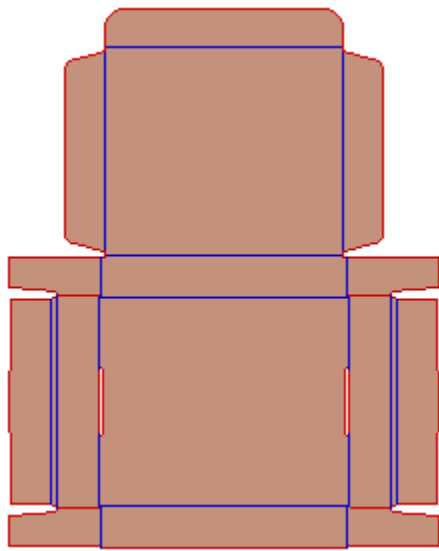

Self-Locking Trays

OT061104

Glue free

Corrugated

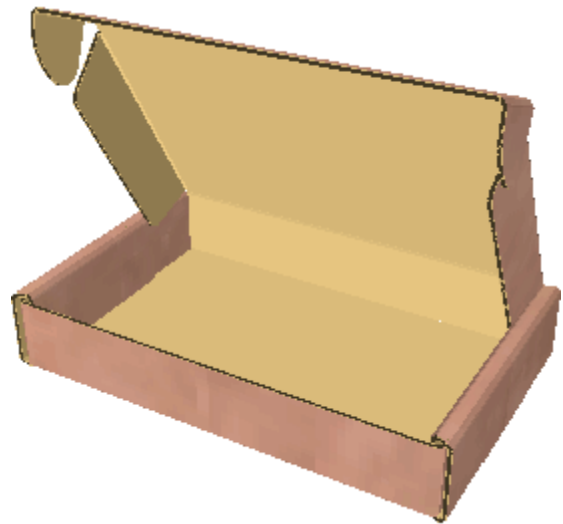
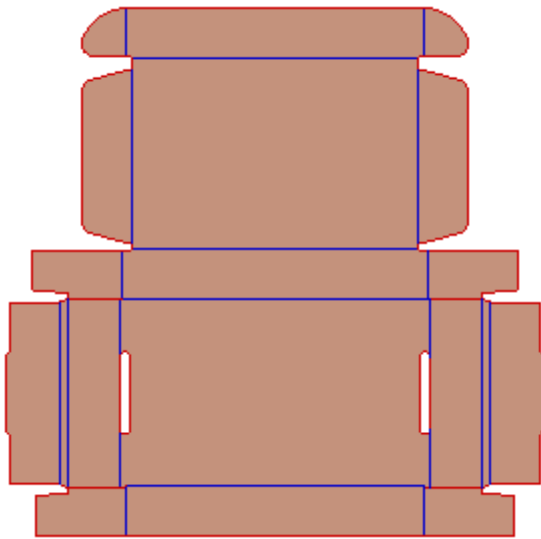

Self-Locking Trays

OT061110

Glue free

Corrugated

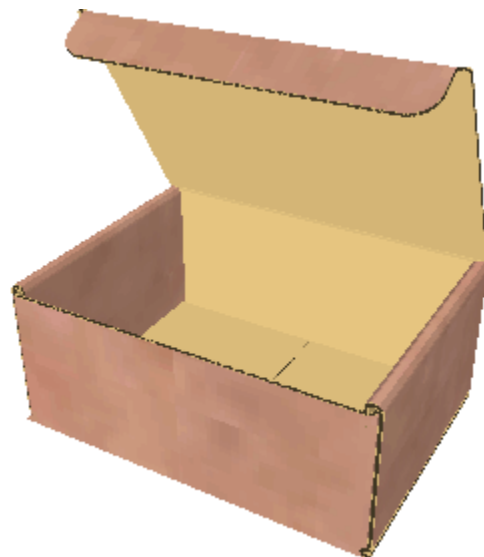
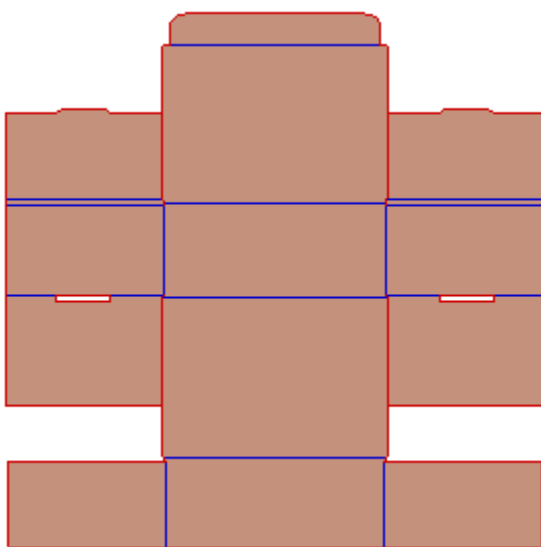

Self-Locking Trays

OT061140

Glue free

Corrugated

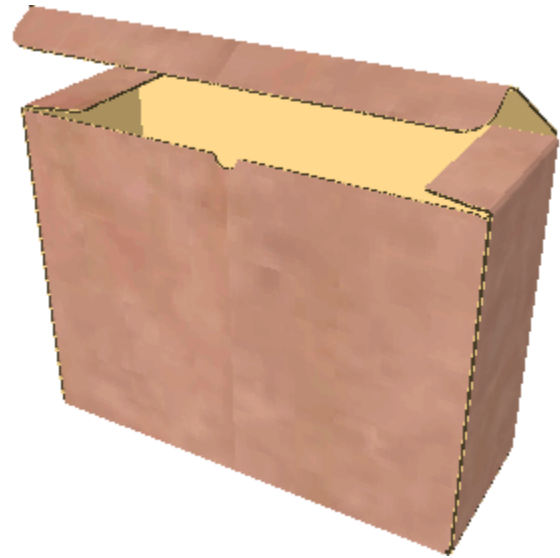
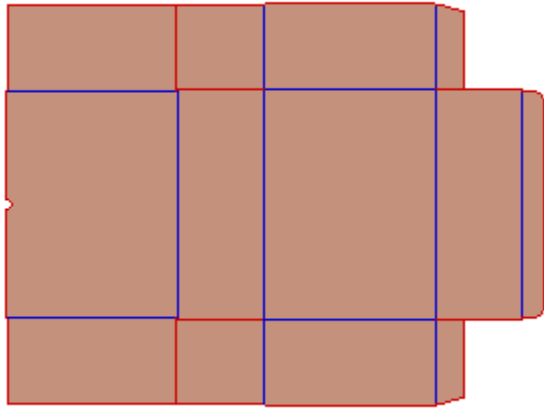

Self-Locking Trays

OT061300

Glue free

Corrugated

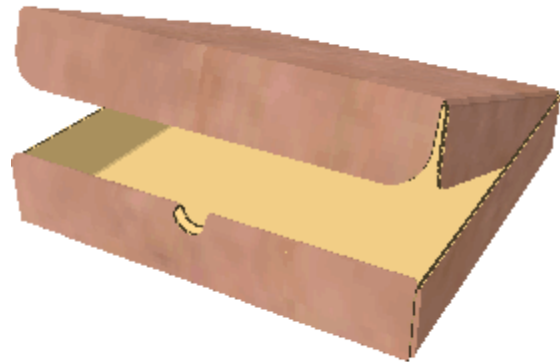
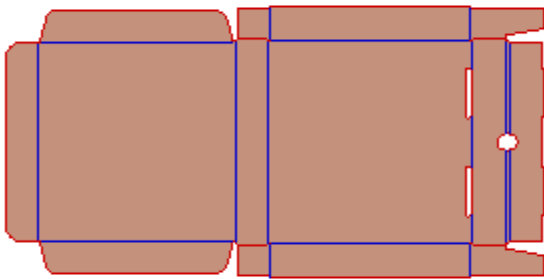

Self-Locking Trays

OT061120

Glue free

Corrugated

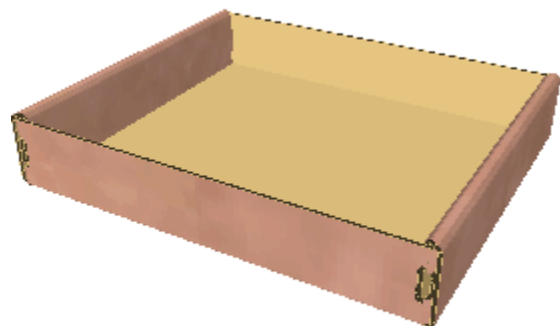
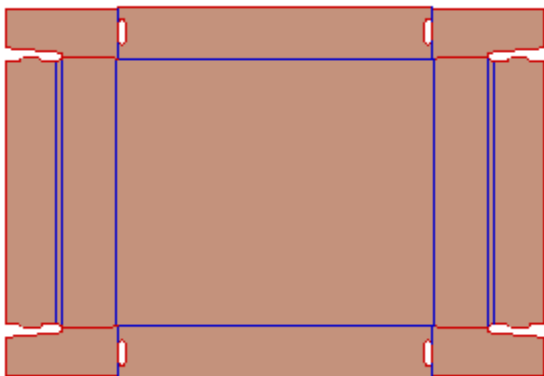

Self-Locking Trays

OT060102

Glue free

Corrugated

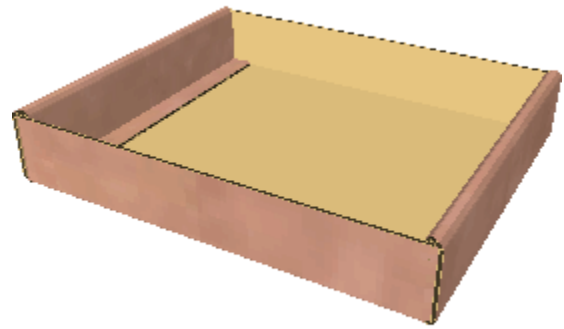
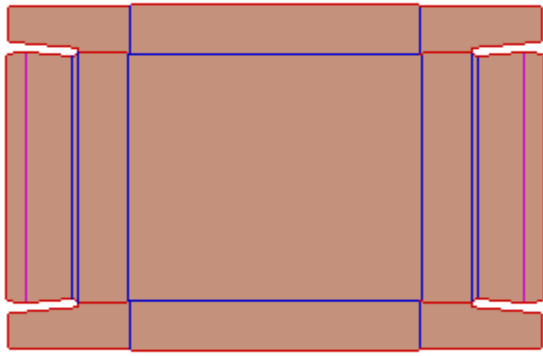

Self-Locking Trays

OT060103

Glue free

Corrugated

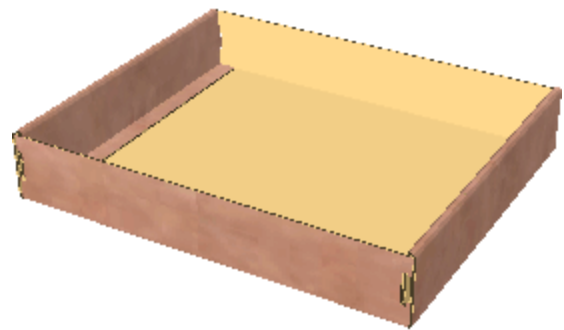
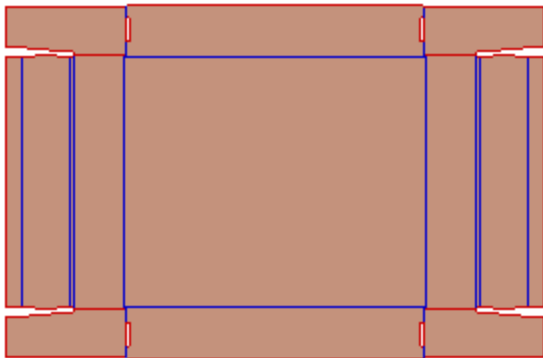

Self-Locking Trays

OT060105

Glue free

Corrugated

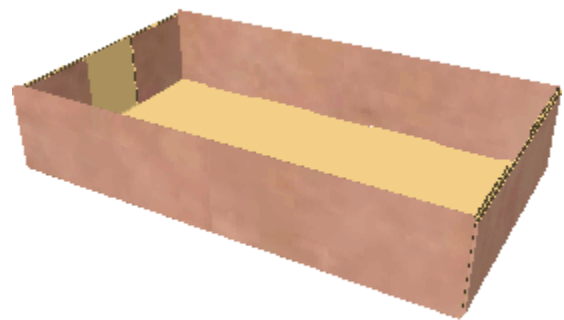
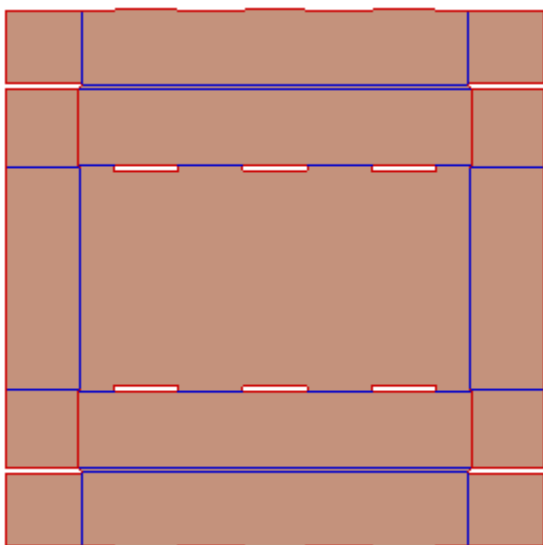

Self-Locking Trays

OT060120_01

Glue free

Corrugated

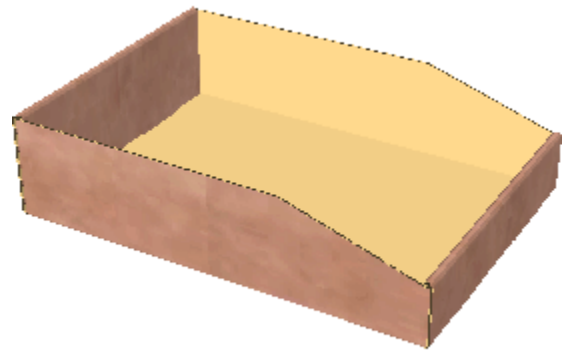
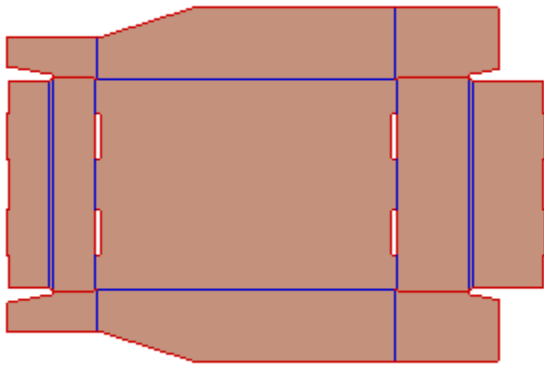

Self-Locking Trays

OT060104

Glue free

Corrugated

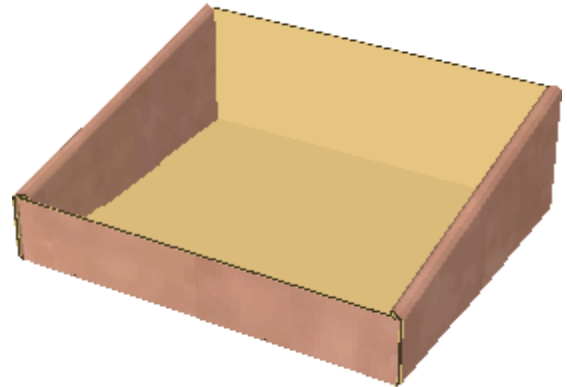
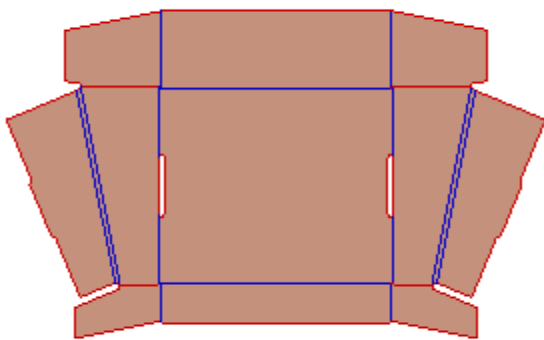

Self-Locking Trays

OT150101

Glue free

Corrugated

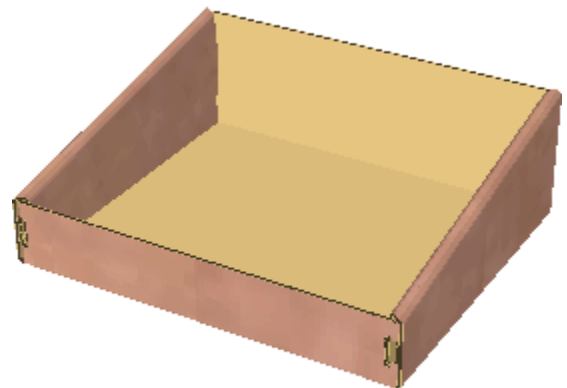
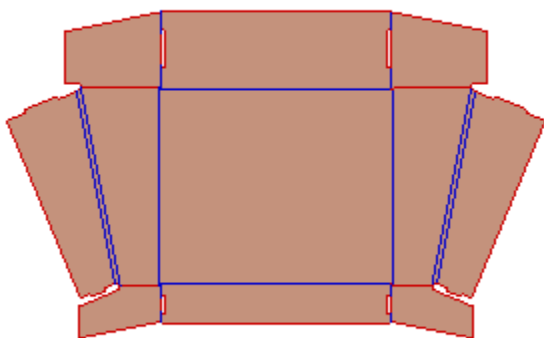

Self-Locking Trays

OT150102

Glue free

Corrugated

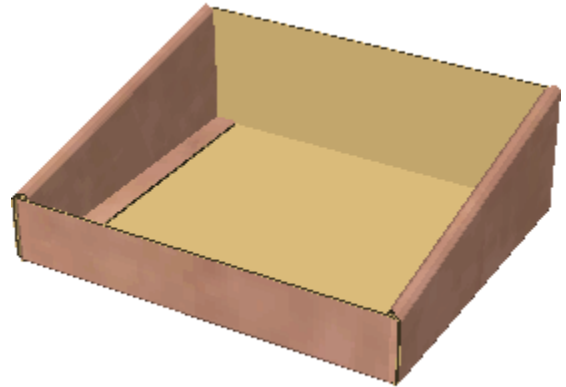
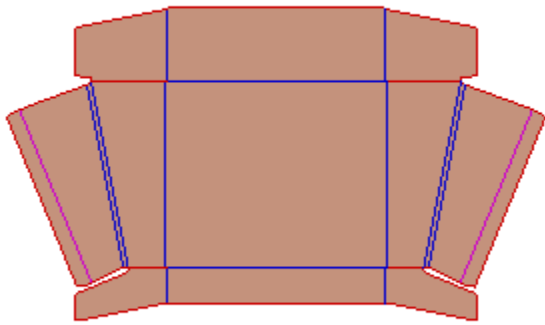

Self-Locking Trays

OT150103

Glue free

Corrugated

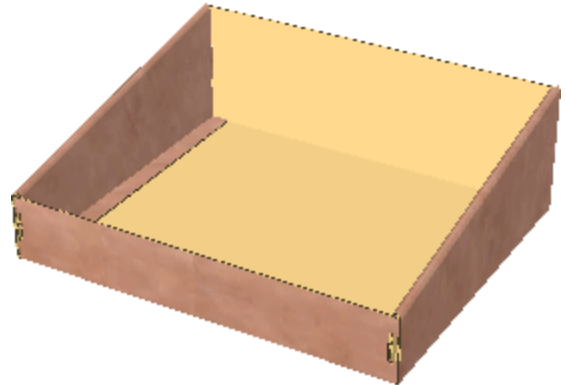
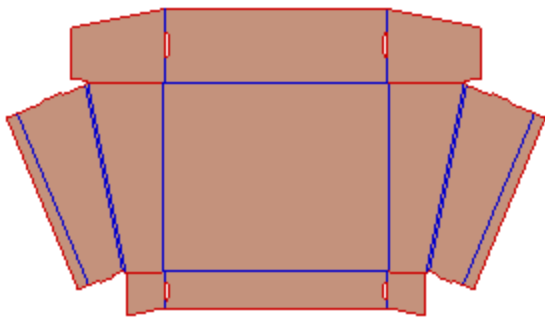

Self-Locking Trays

OT060110

Glue free

Corrugated

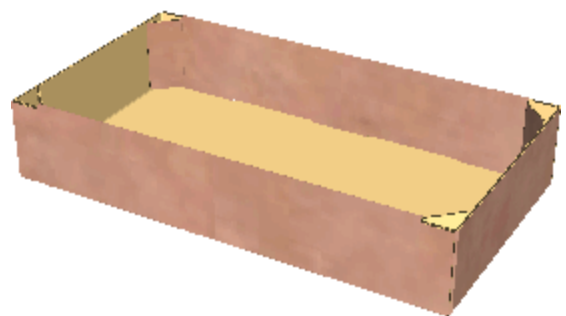
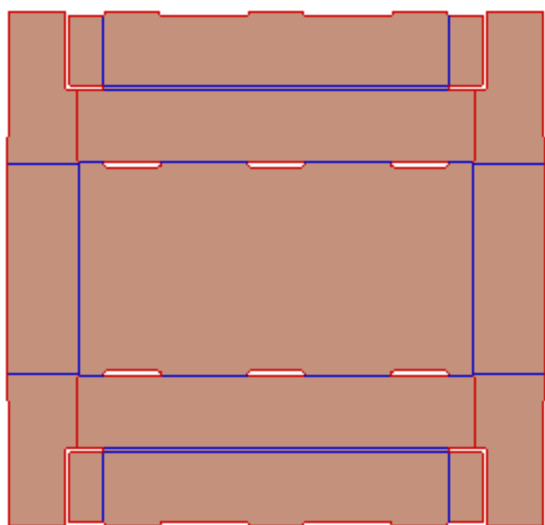

Self-Locking Trays

OT060123

Glue free

Corrugated

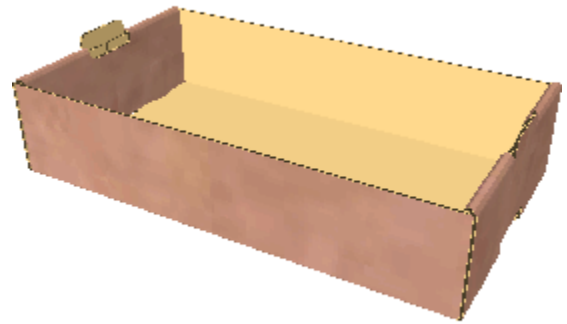
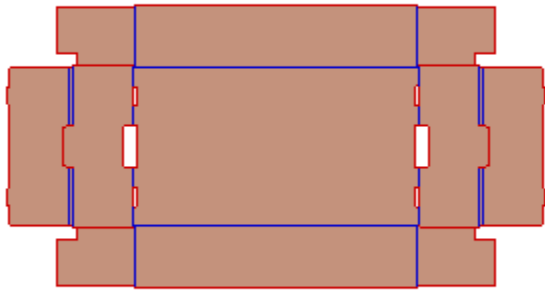

Self-Locking Trays

OT060141_01

Glue free

Corrugated

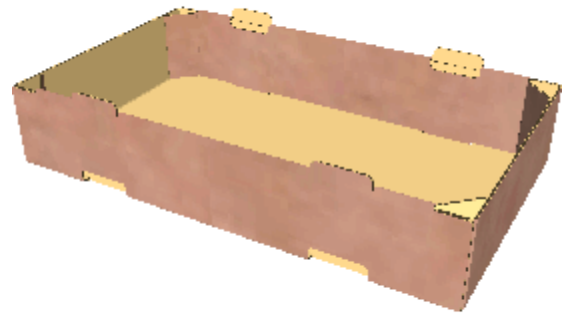
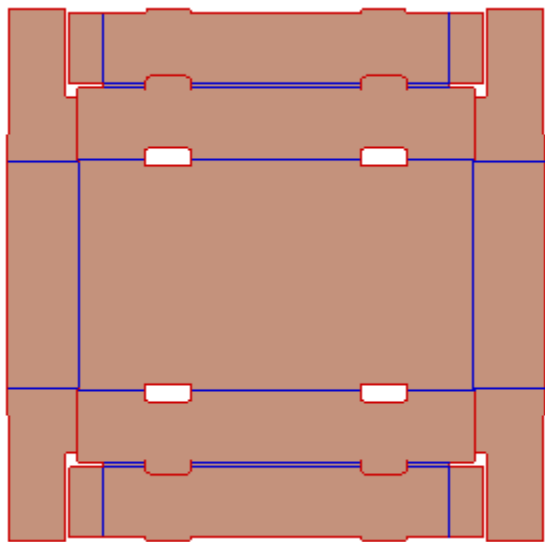

Self-Locking Trays

OT060121_01

Glue free

Corrugated

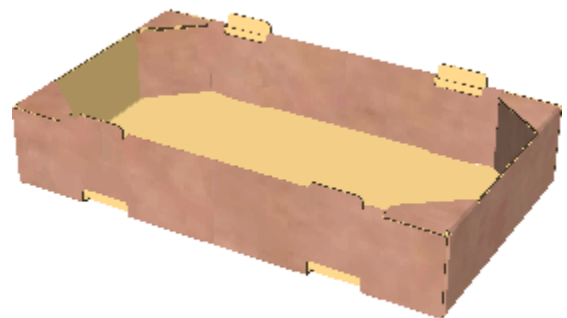
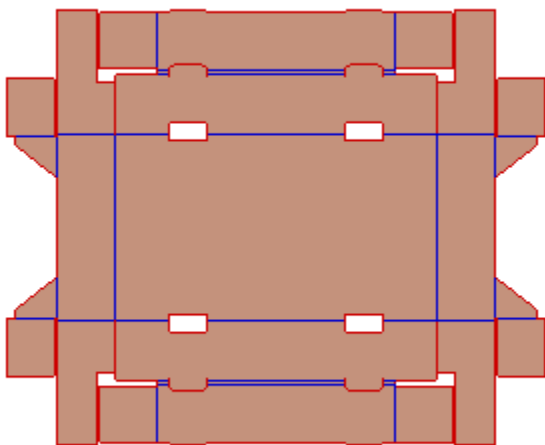

Self-Locking Trays

OT060150_01

Glue free

Corrugated

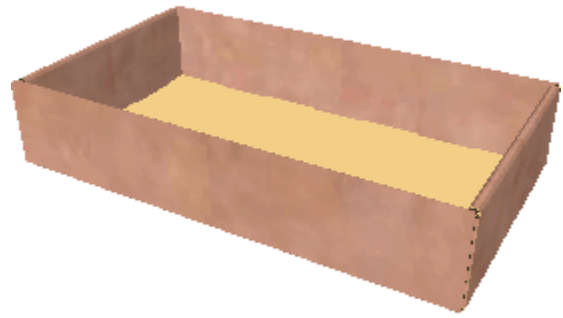
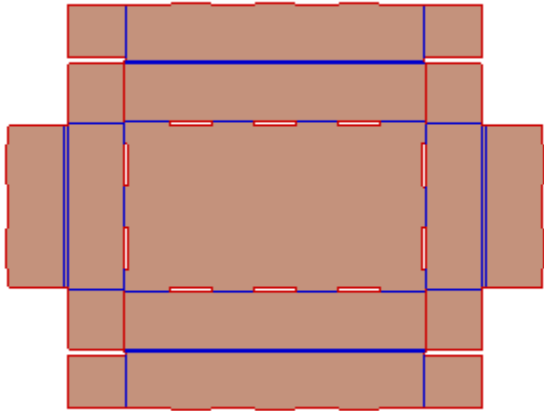

Self-Locking Trays

OT060131_01

Glue free

Corrugated

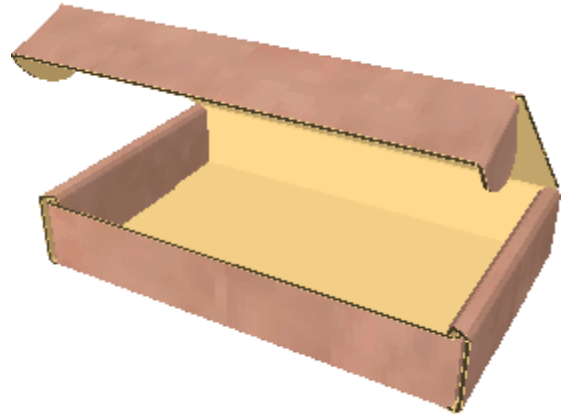
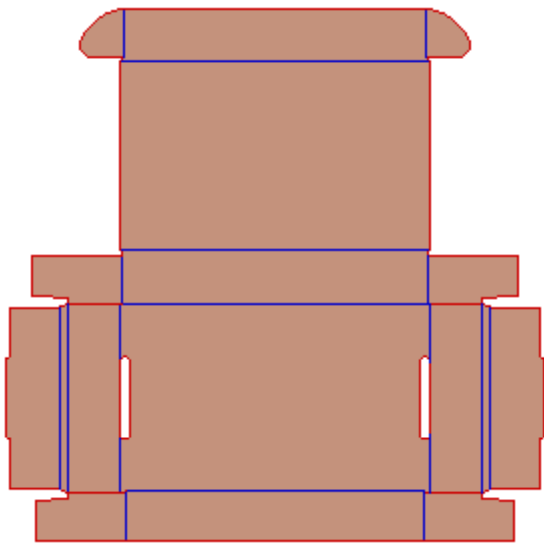

Self-Locking Trays

OT061111

Glue free

Corrugated

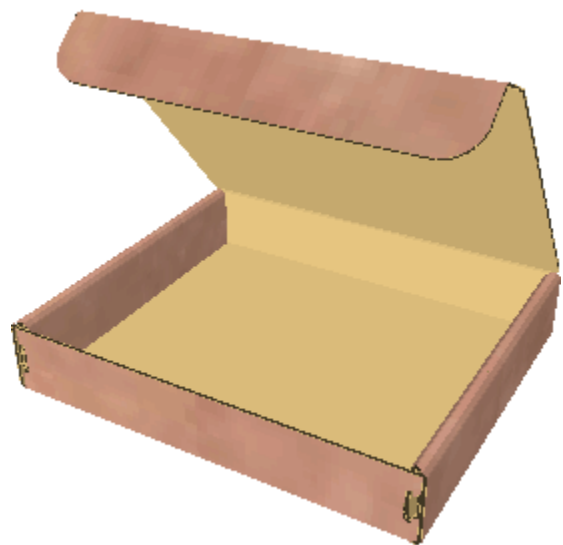
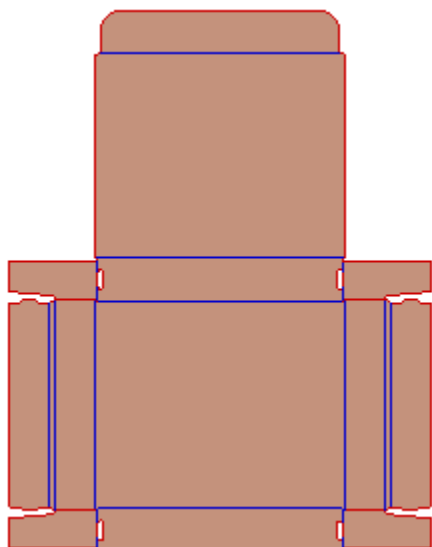

Self-Locking Trays

OT061102

Glue free

Corrugated

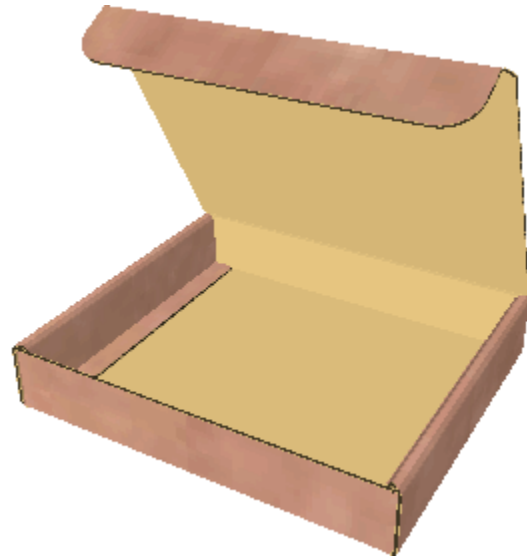
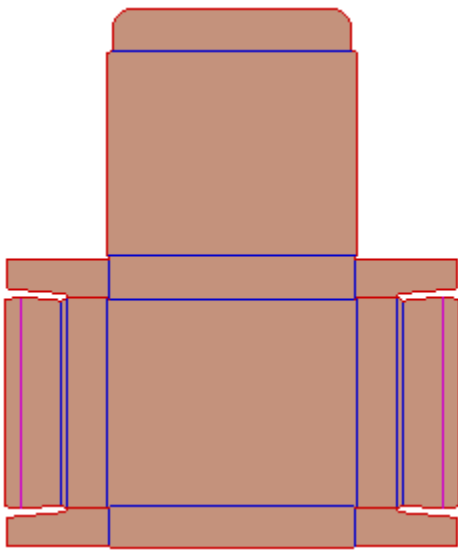

Self-Locking Trays

OT061103

Glue free

Corrugated

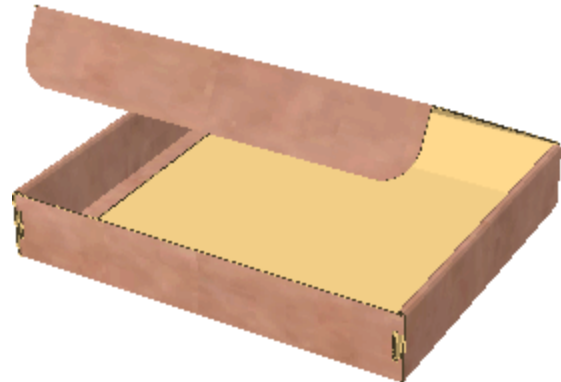
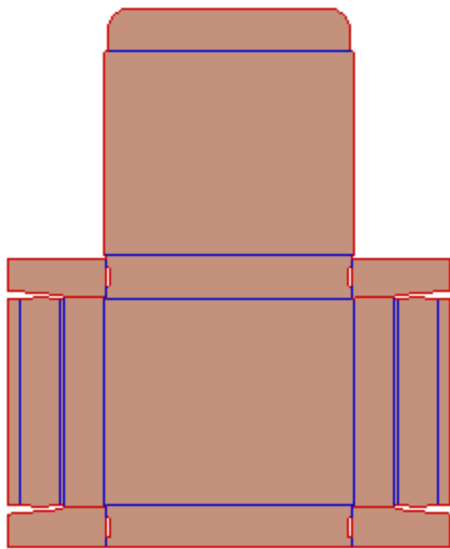

Self-Locking Trays

OT061106

Glue free

Corrugated

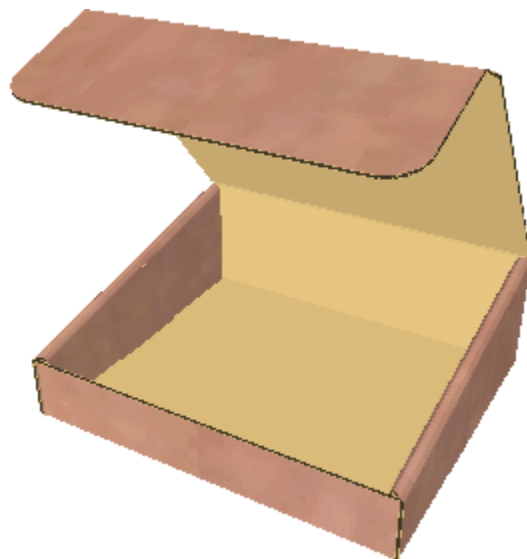
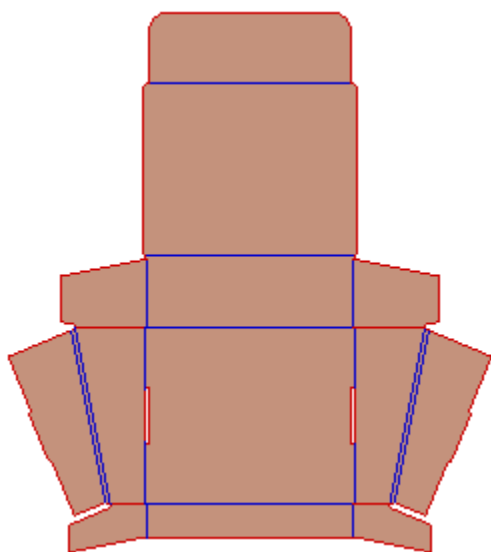

Self-Locking Trays

OT151101

Glue free

Corrugated

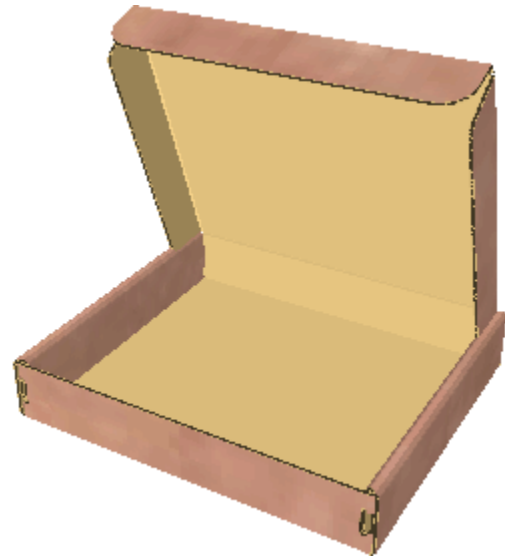
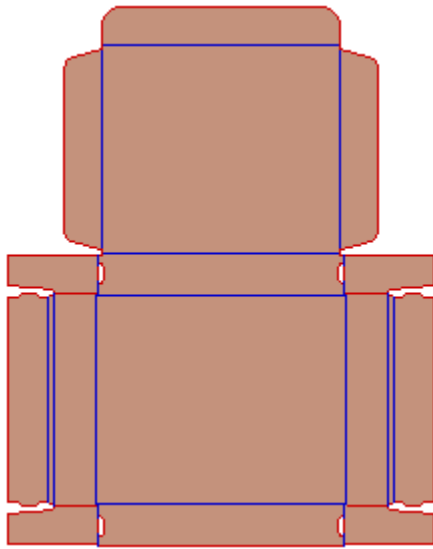

Self-Locking Trays

OT061105

Glue free

Corrugated

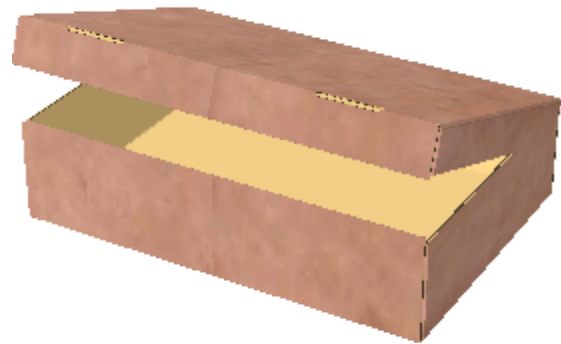
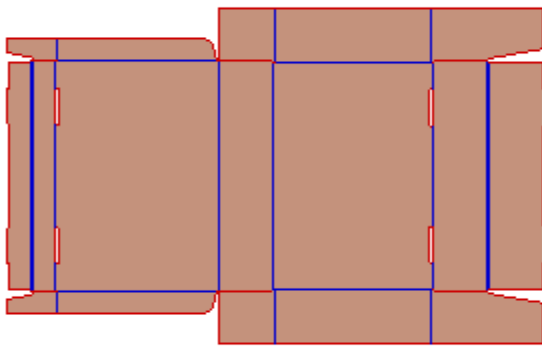

Self-Locking Trays

OT061121

Glue free

Corrugated

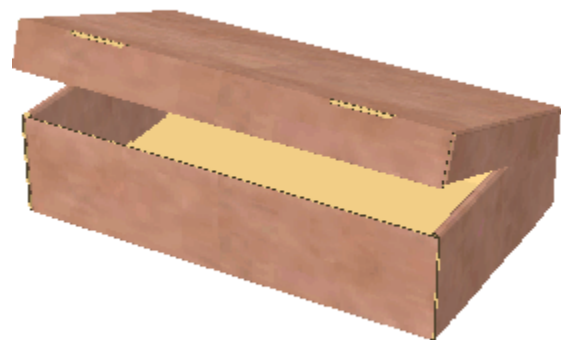
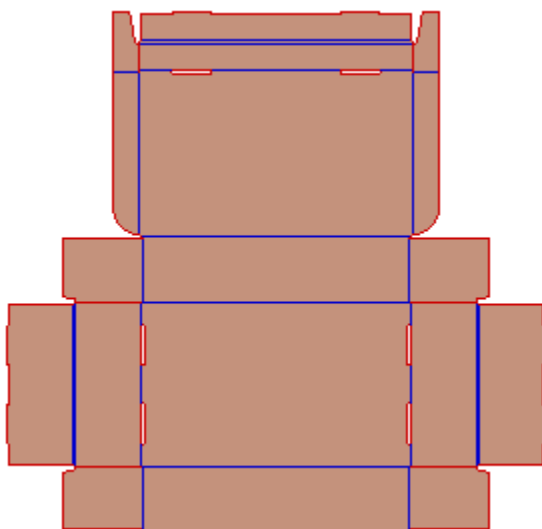

Self-Locking Trays

OT061130

Glue free

Corrugated

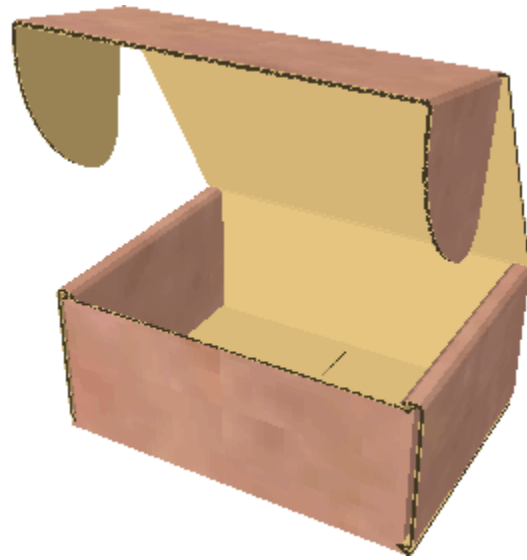
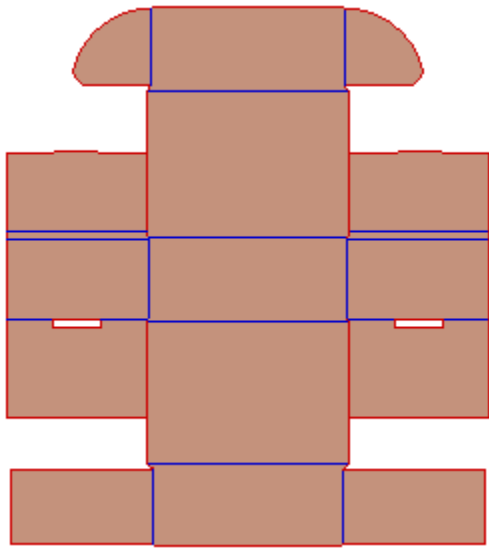

Self-Locking Trays

OT061150

Glue free

Corrugated

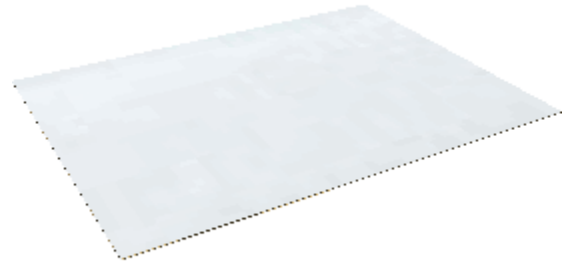

Blisters

LT070001

Glue free

Compact & E flute

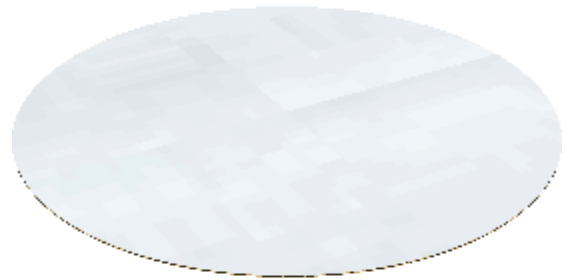
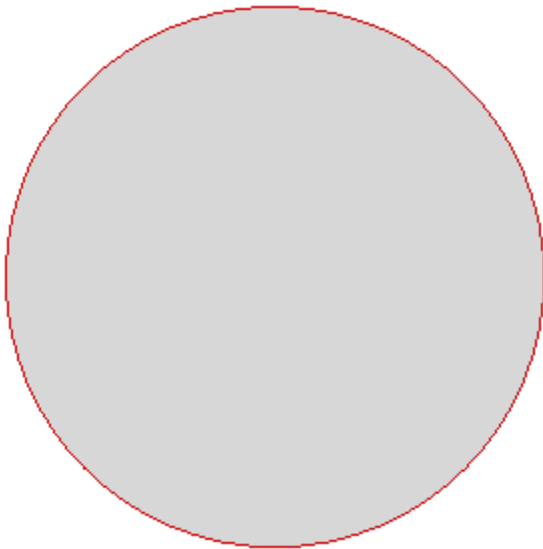

Blisters

LT070003

Glue free

Compact & E flute

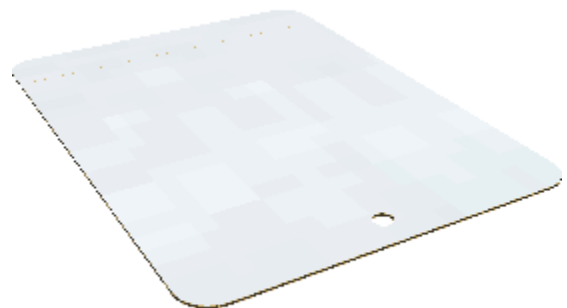

Blisters

LT070101

Glue free

Compact & E flute

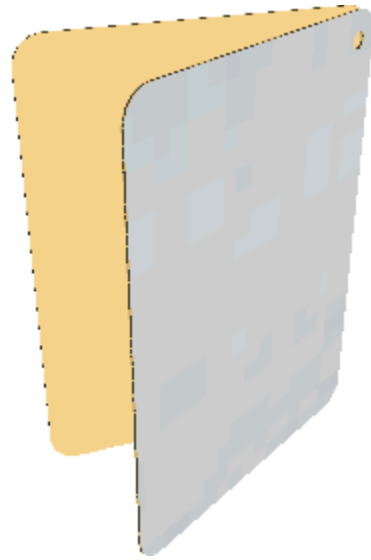
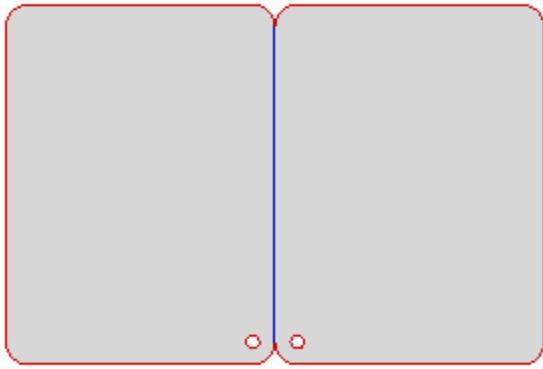

Blisters

LT070102

Glue free

Compact & E flute

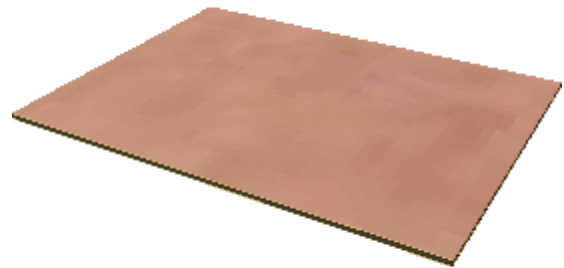

Blisters

OT070001

Glue free

Corrugated

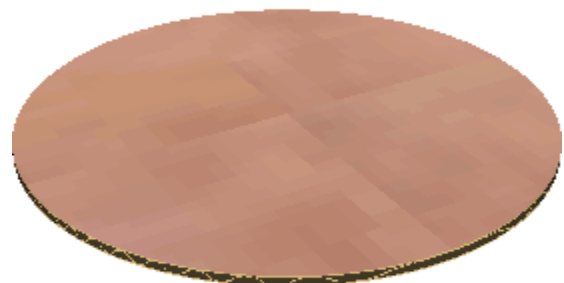
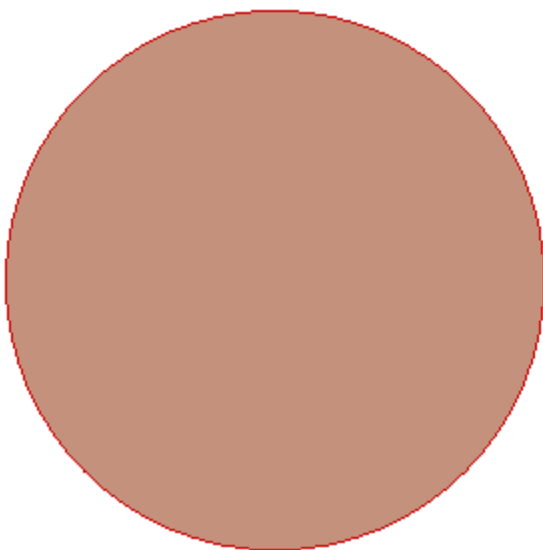

Blisters

OT070003

Glue free

Corrugated

Folders

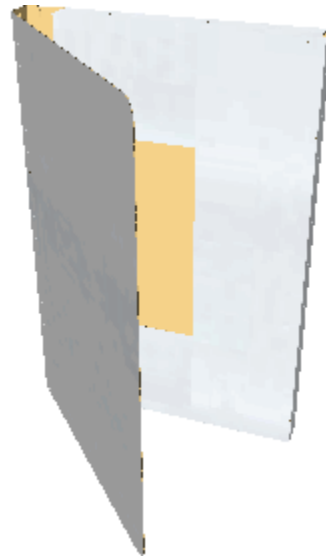
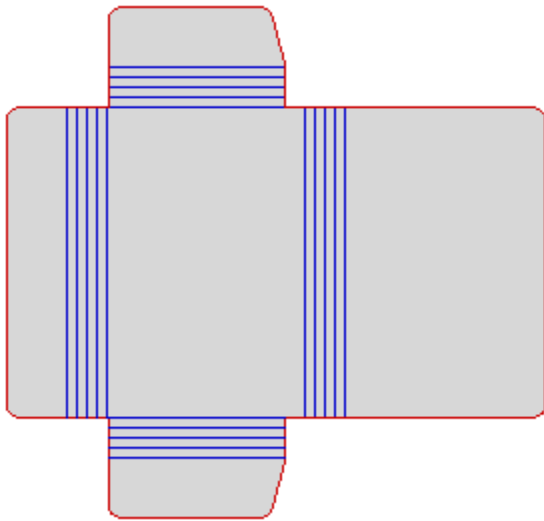

LT080203

Glue free

Compact & E flute

Folders

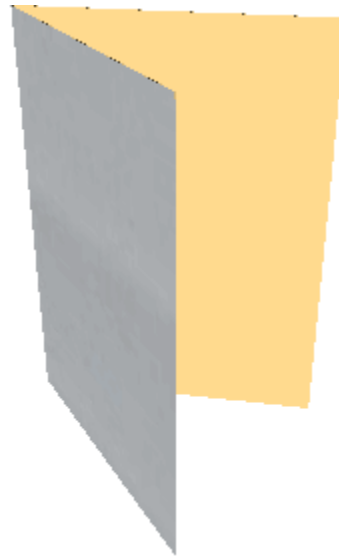
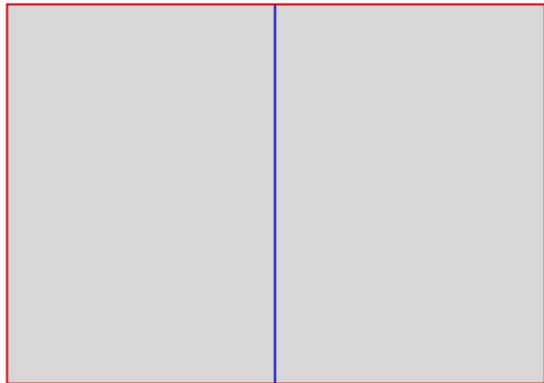

LT080200

Glue free

Compact & E flute

Folders

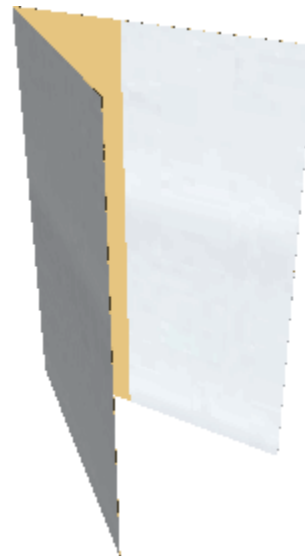
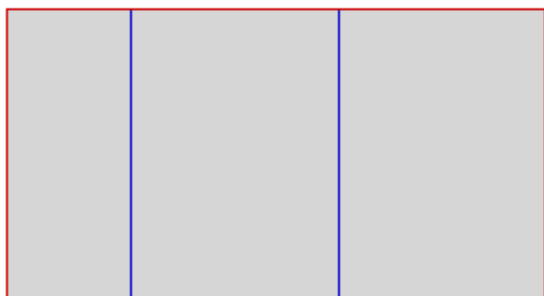

LT080204

Glue free

Compact & E flute

Folders

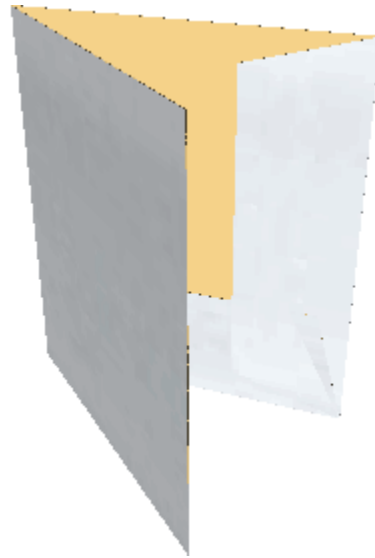
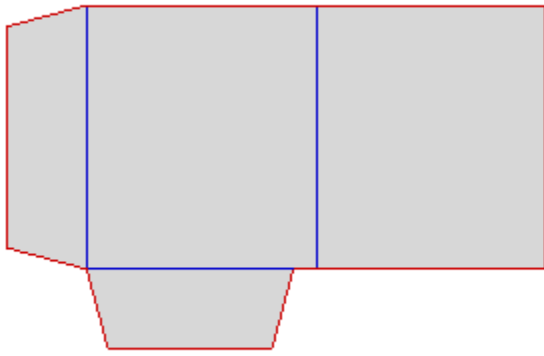

LT080201

Glue free

Compact & E flute

Folders

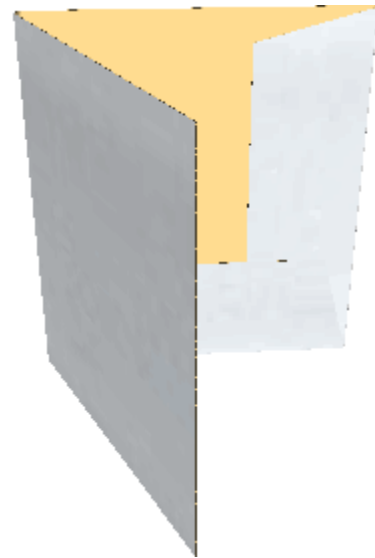
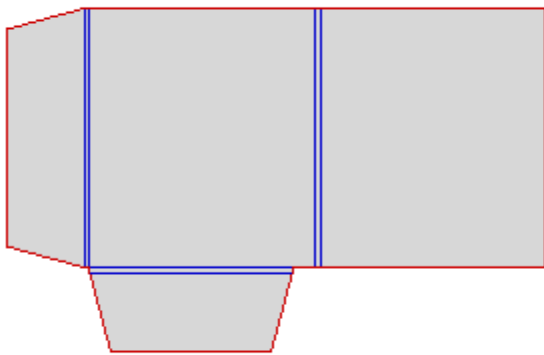

LT081200

Glue free

Compact & E flute

Folders

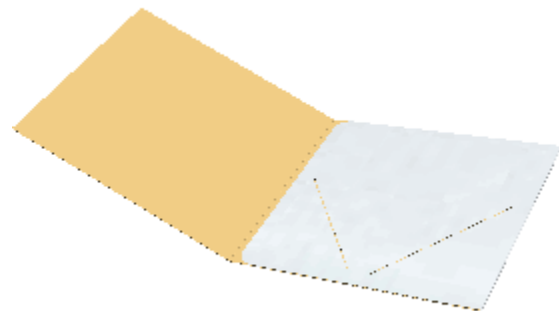
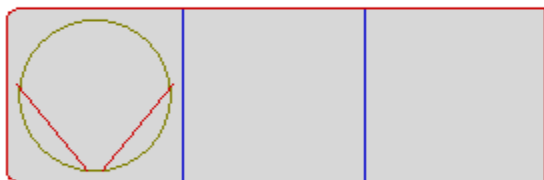

LT080205

Glue free

Compact

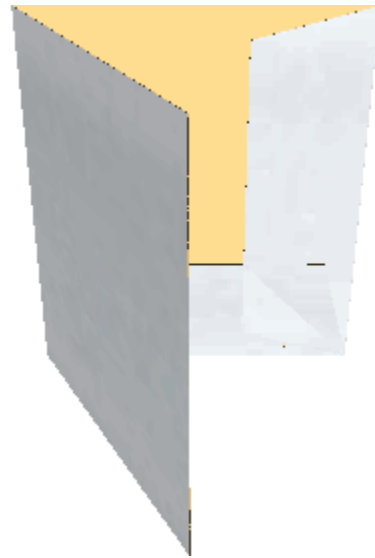
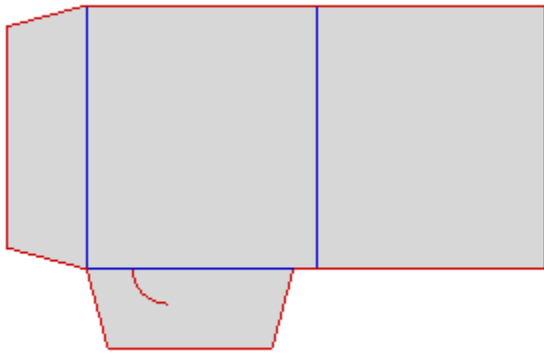

Folders

LT083200

Glue free

Compact & E flute

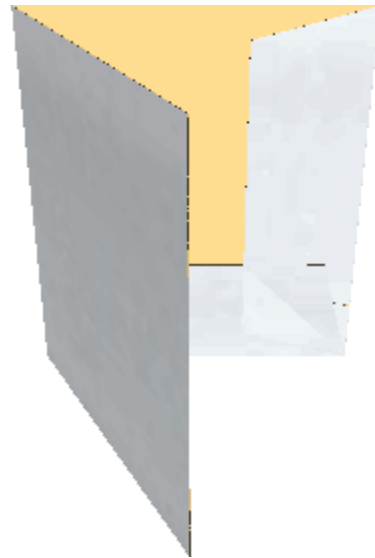
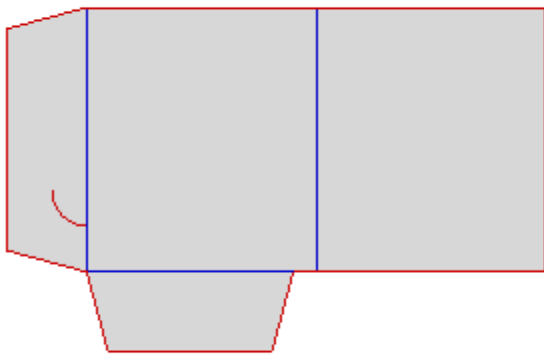

Folders

LT083201

Glue free

Compact & E flute

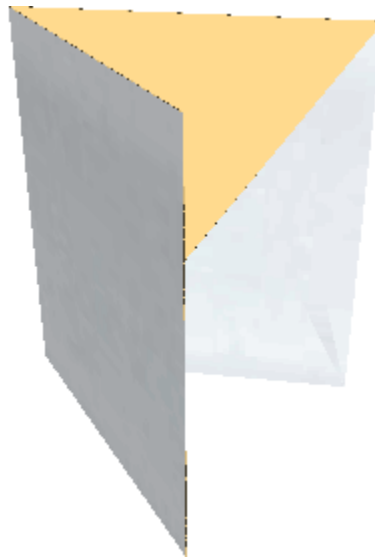
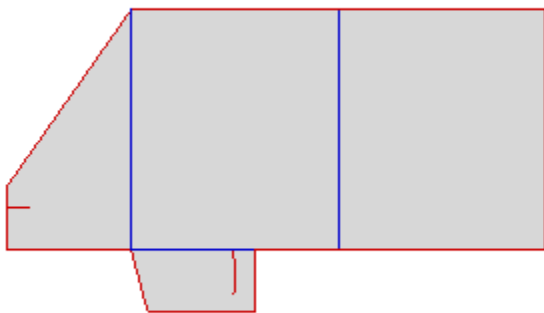

Folders

LT083202

Glue free

Compact & E flute

Folders

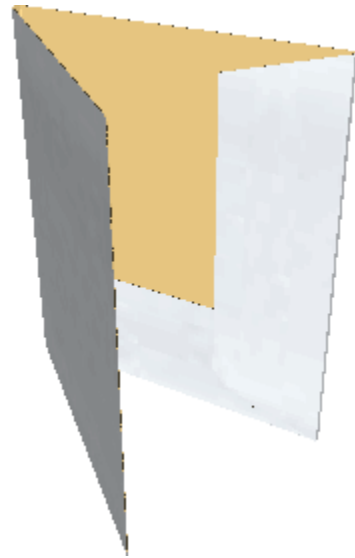
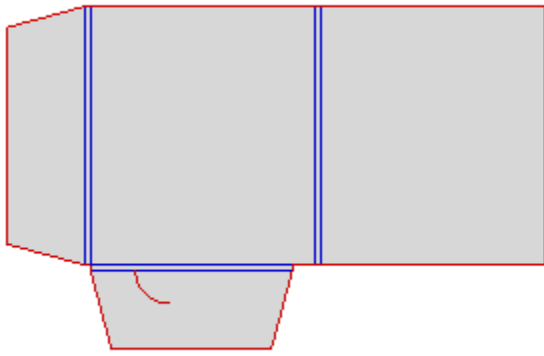

LT083203

Glue free

Compact & E flute

Folders

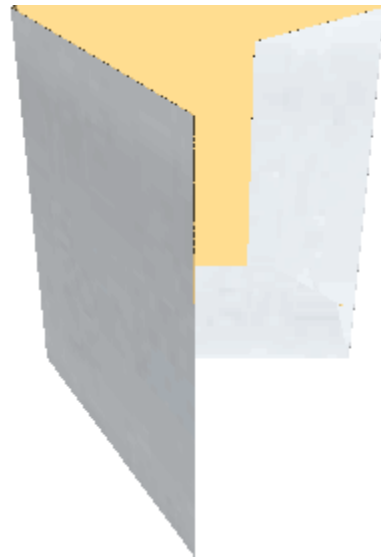
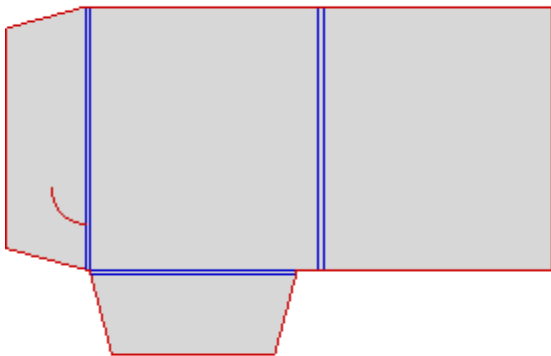

LT083204

Glue free

Compact & E flute

Folders

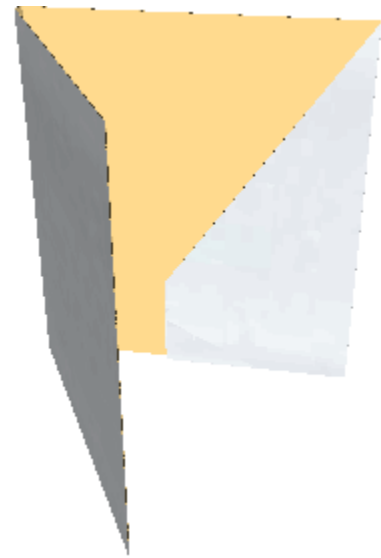
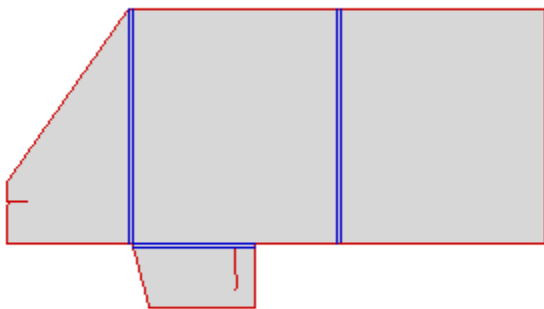

LT083205

Glue free

Compact & E flute

Folders

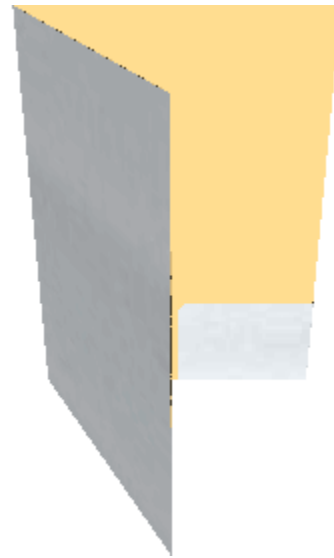
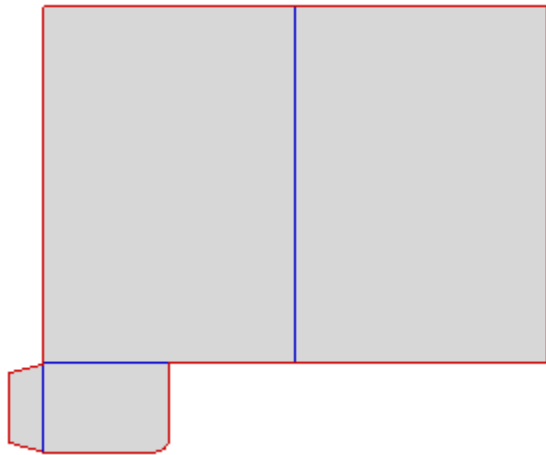

LT082201

Straight line

Compact & E flute

Folders

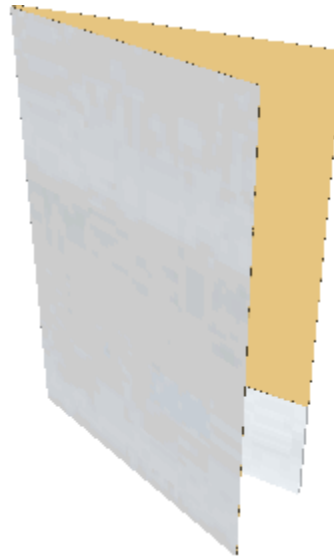
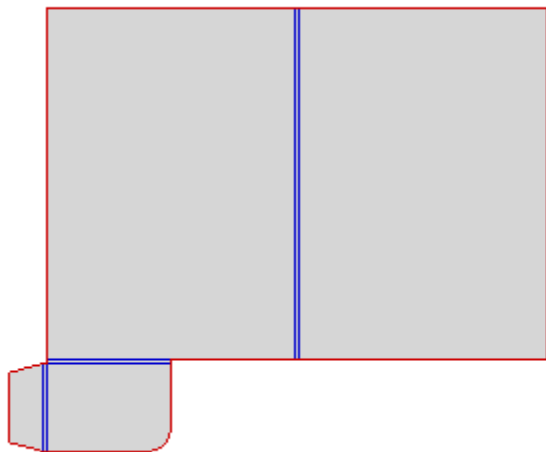

LT082251

Straight line

Compact & E flute

Folders

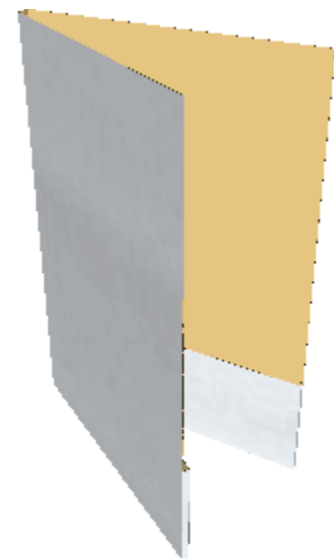
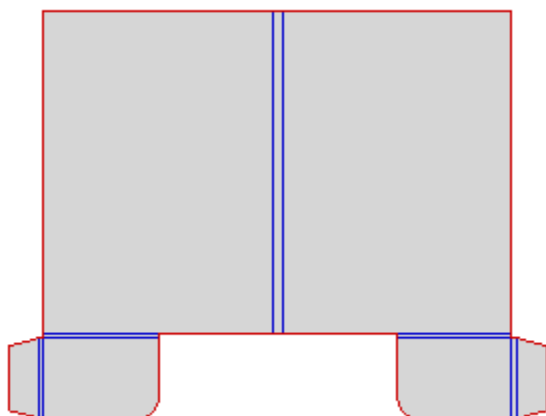

LT082252

Straight line

Compact & E flute

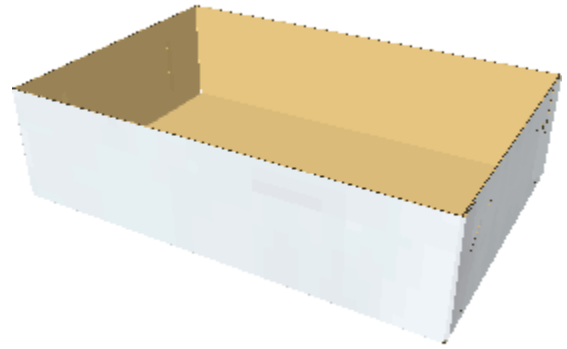
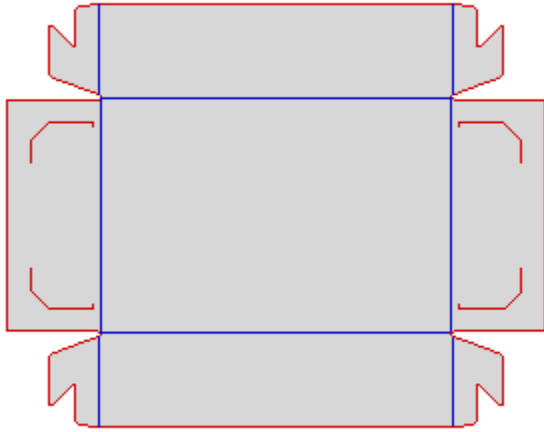

Cllic-Cloc

LT090001

Glue free

Compact & E flute

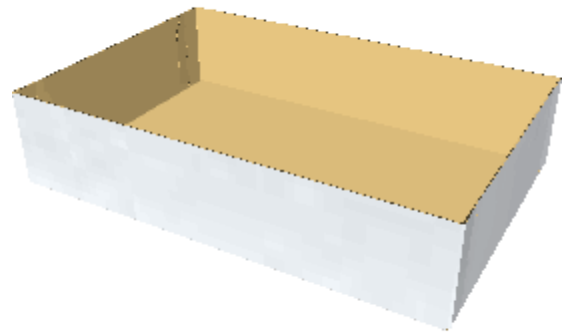
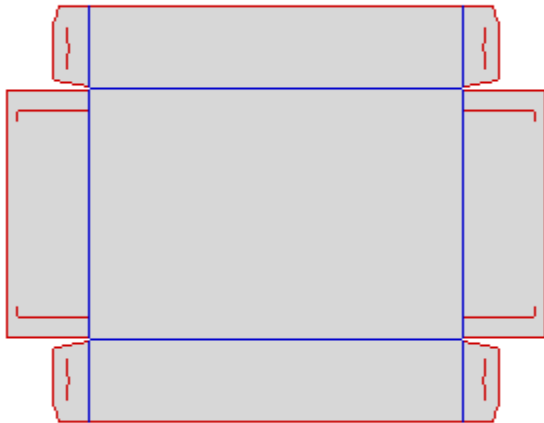

Cllic-Cloc

LT090003

Glue free

Compact & E flute

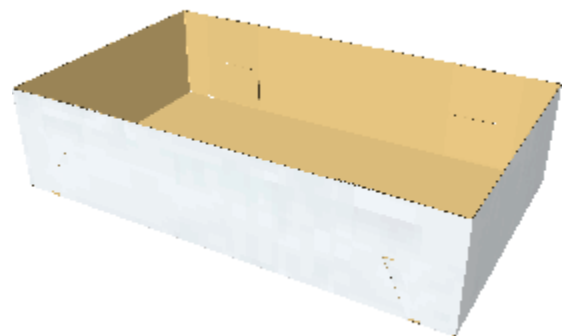
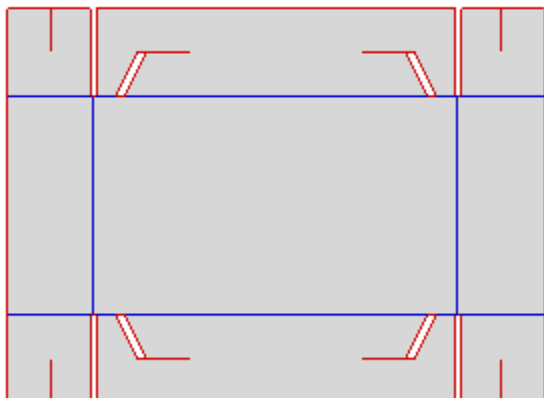

Cllic-Cloc

LT090002

Glue free

Compact & E flute

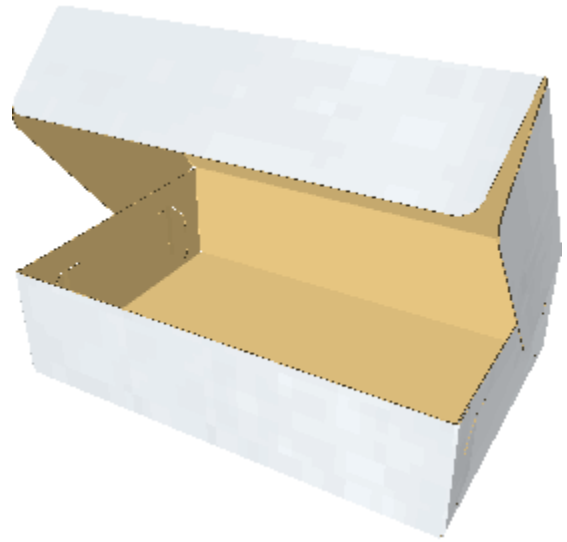
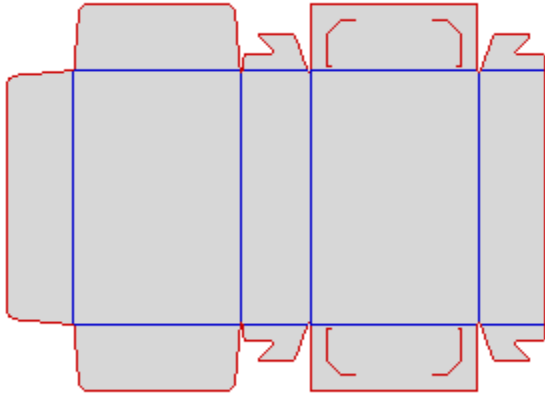

Clic-Cloc

LT091001

Packers

Compact & E flute

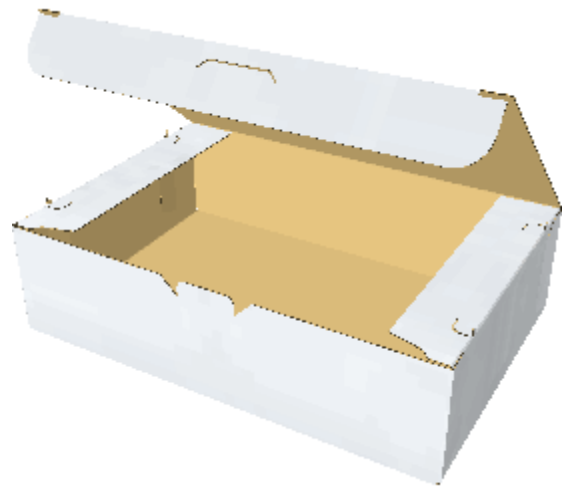
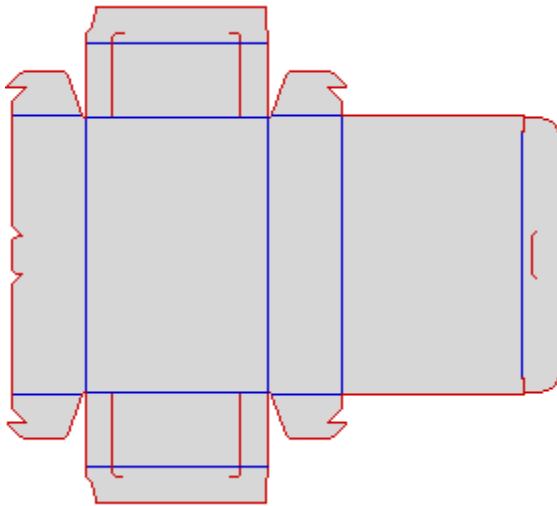

Clic-Cloc

LT091020

Glue free

Compact & E flute

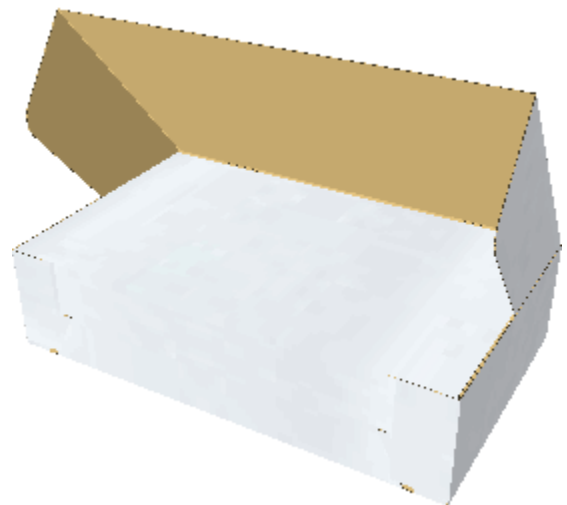
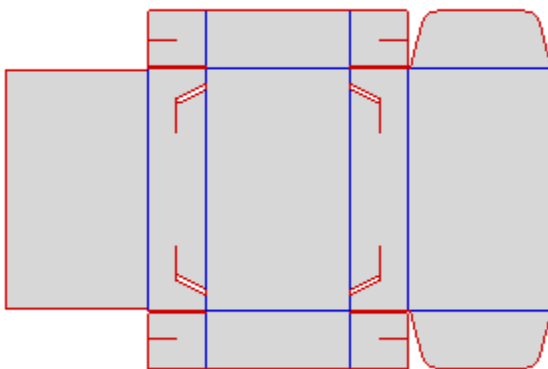

Clic-Cloc

LT091002

Packers

Compact & E flute

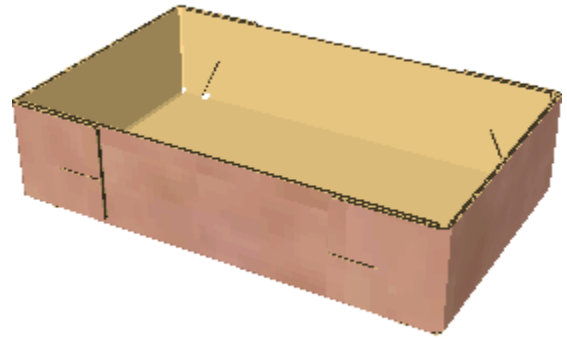
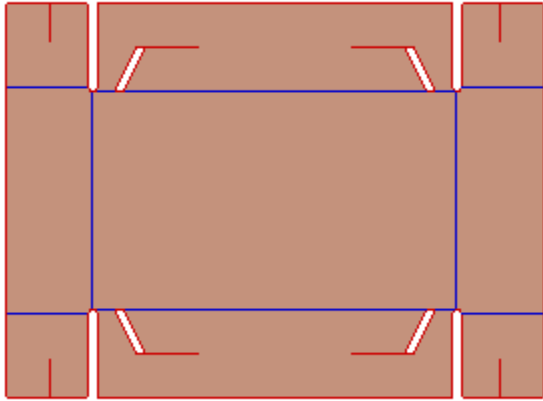

Clic-Cloc

OT090002

Glue free

Corrugated

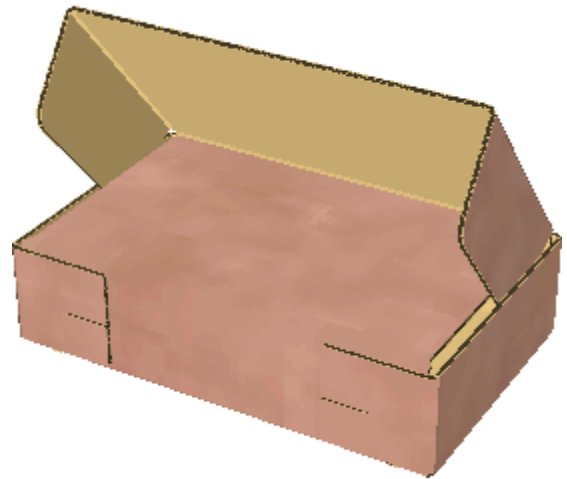
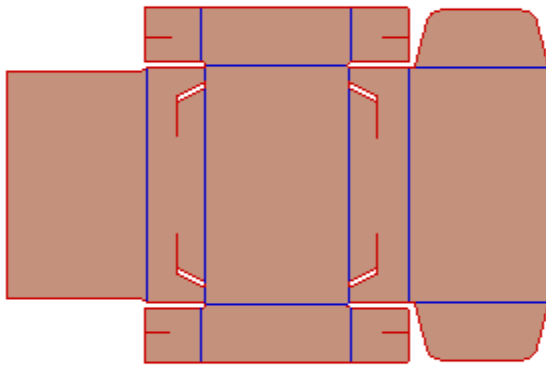

Clic-Cloc

OT091002

Glue free

Corrugated

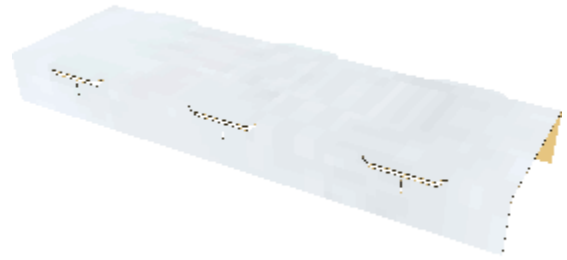
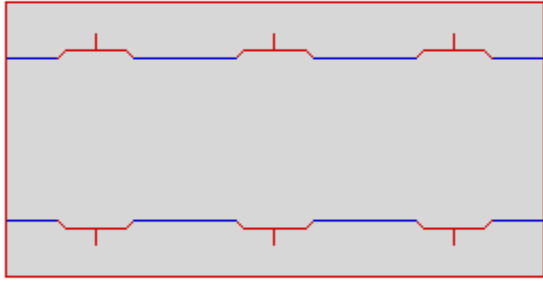

Cluster Pack

LT101101

Glue free

Compact & E flute

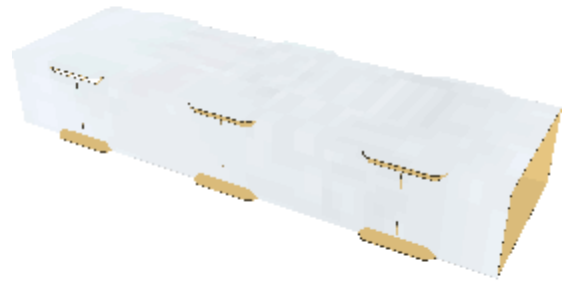
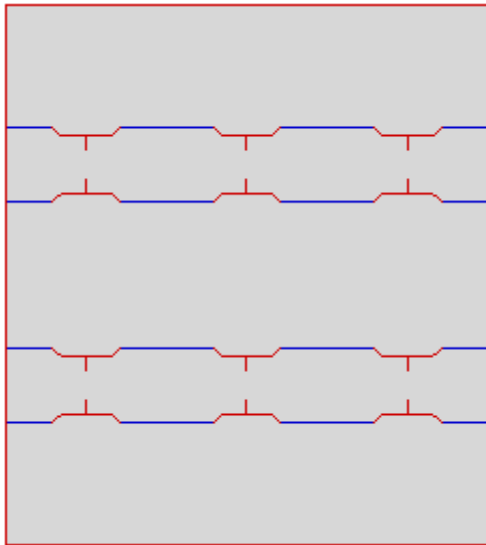

Cluster Pack

LT102101

Packers

Compact & E flute

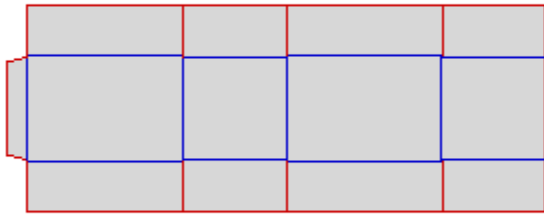

Overlap Seal ends

LT113001_01

Straight line

Compact & E flute

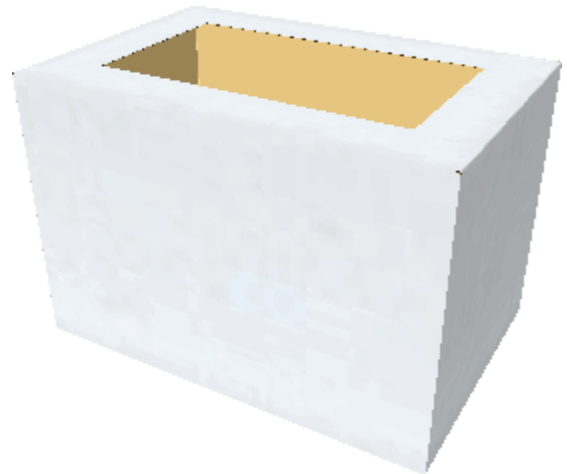
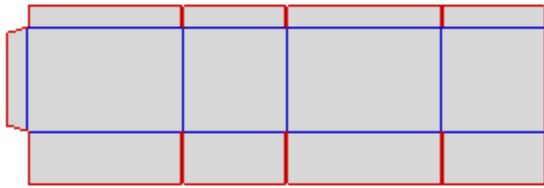

Overlap Seal ends

LT113005

Straight line

Compact & E flute

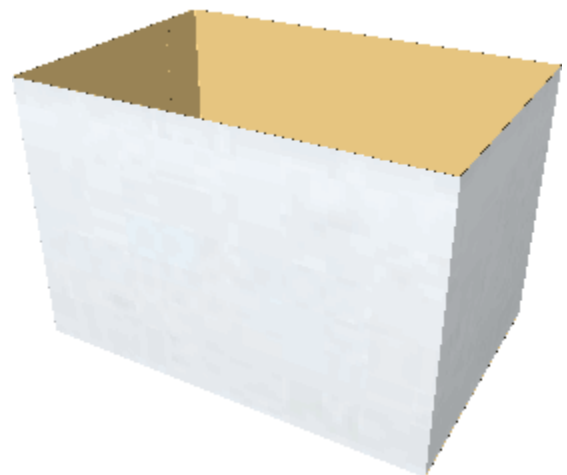

Overlap Seal ends

LT113000

Straight line

Compact & E flute

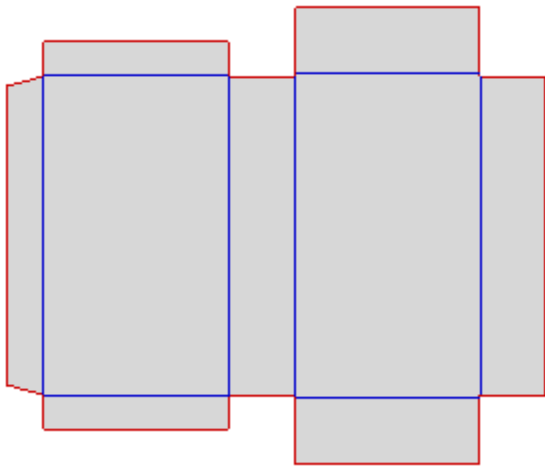

Overlap Seal ends

LT113040

Straight line

Compact & E flute

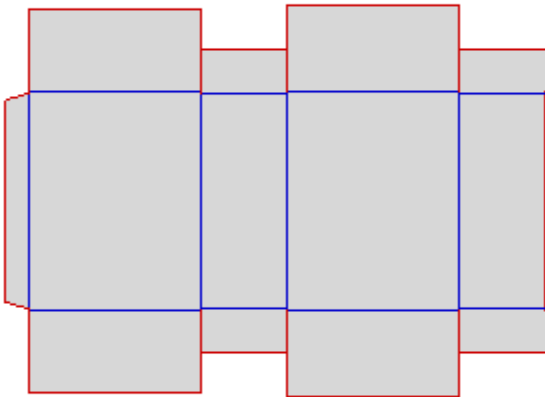

Overlap Seal ends

LT113041

Straight line

Compact & E flute

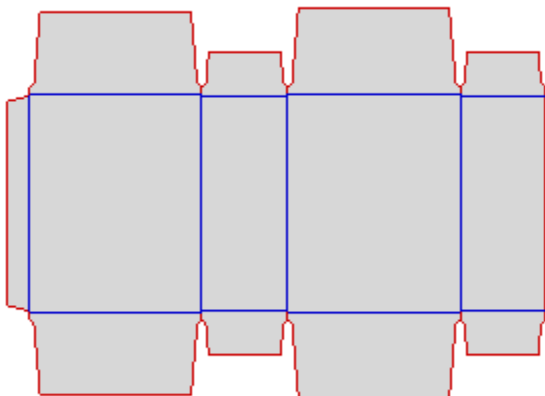

Overlap Seal ends

LT113042

Straight line

Compact & E flute

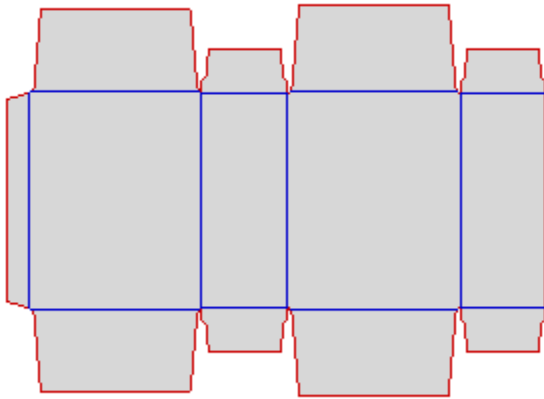

Overlap Seal ends

LT113043

Straight line

Compact & E flute

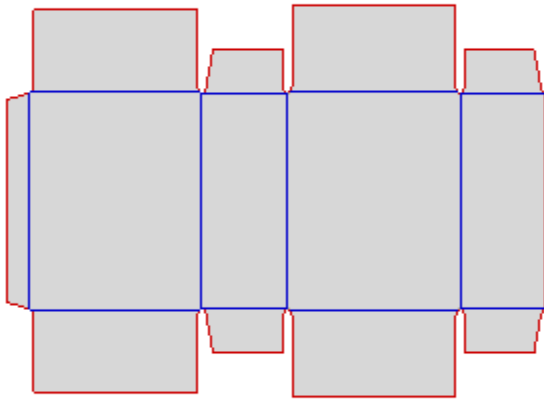

Overlap Seal ends

LT113044

Straight line

Compact & E flute

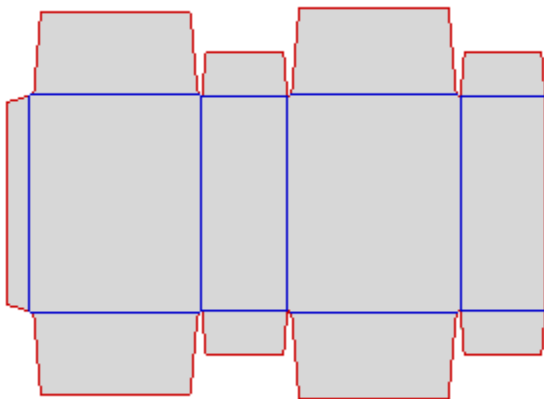

Overlap Seal ends

LT113045

Straight line

Compact & E flute

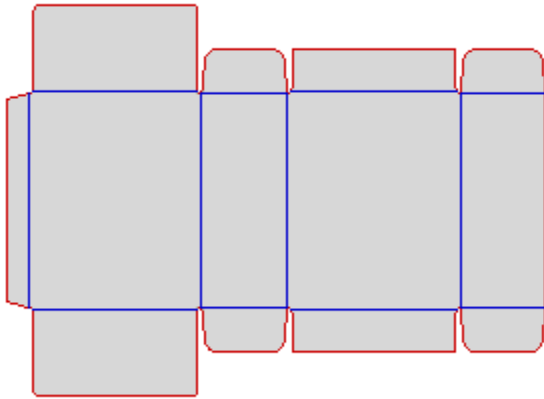

Overlap Seal ends

LT113046

Straight line

Compact & E flute

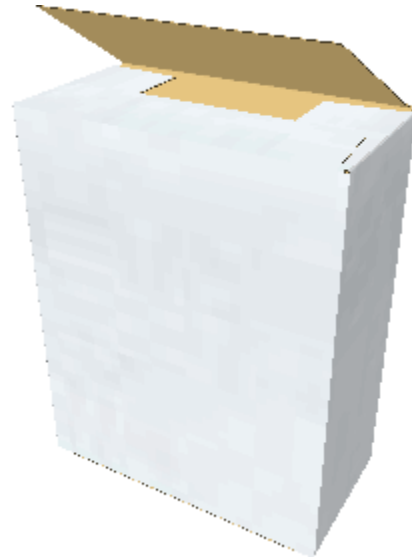
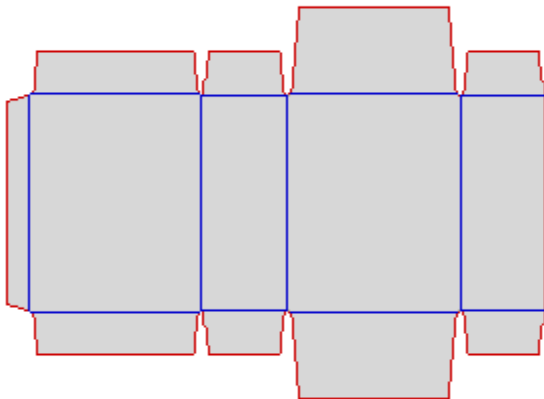

Overlap Seal ends

LT113047

Straight line

Compact & E flute

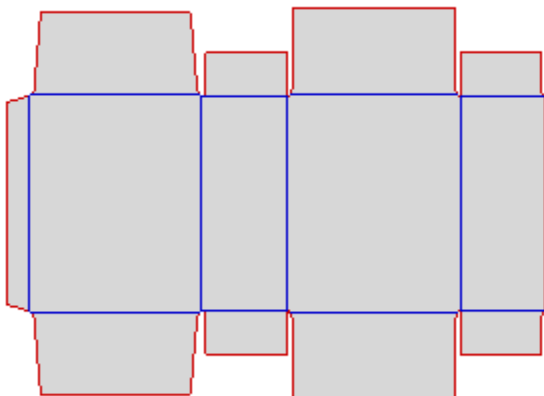

Overlap Seal ends

LT113048

Straight line

Compact & E flute

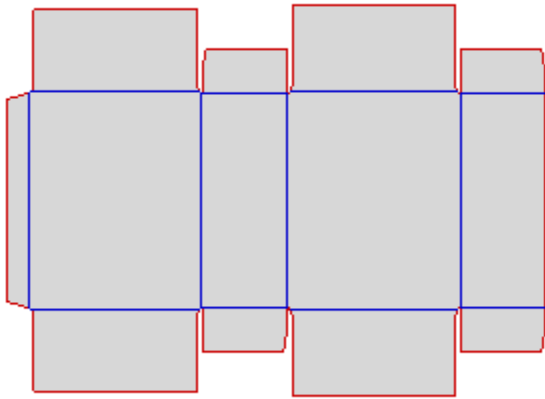

Overlap Seal ends

LT113049

Straight line

Compact & E flute

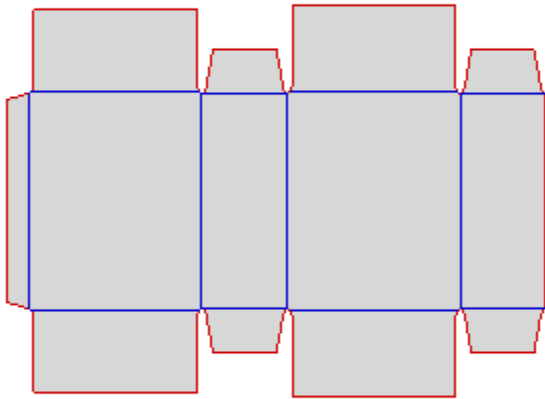

Overlap Seal ends

LT113050

Straight line

Compact & E flute

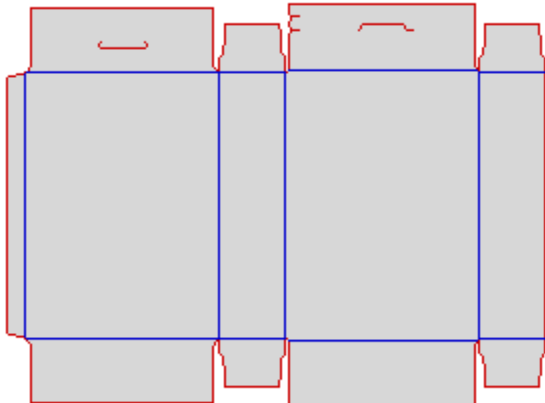

Overlap Seal ends

LT113020

Straight line

Compact & E flute

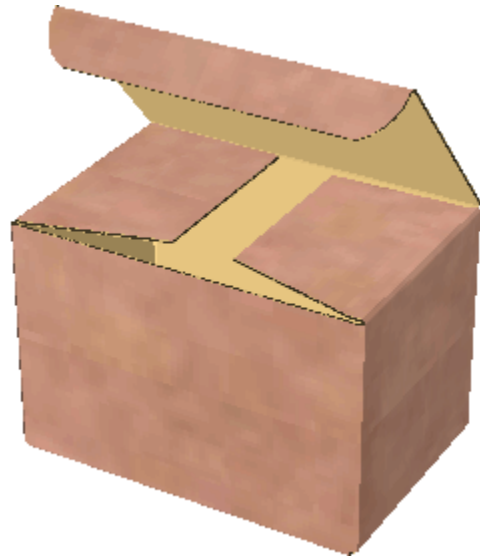
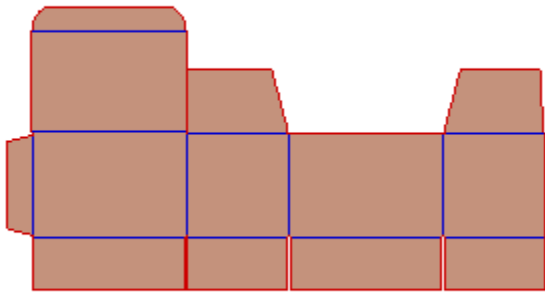

Overlap Seal ends

OT111001

Straight line

Corrugated

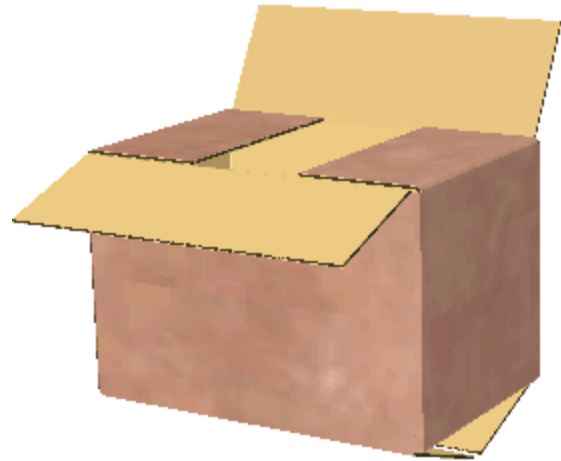
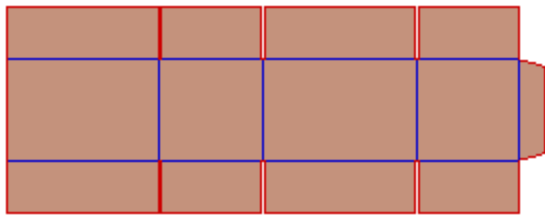

Overlap Seal ends

OT113001_01

Straight line

Corrugated

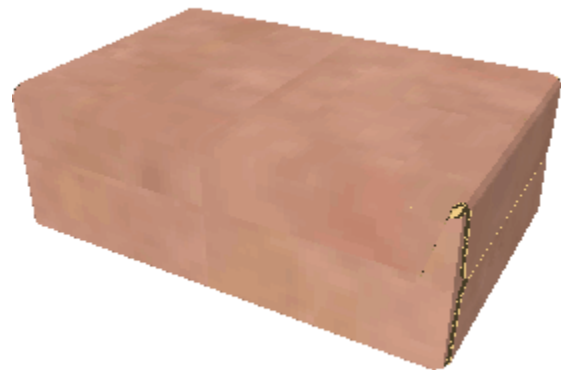
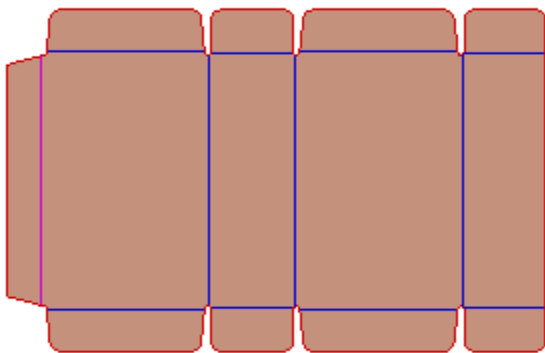

Overlap Seal ends

OT113100

Packers

Corrugated

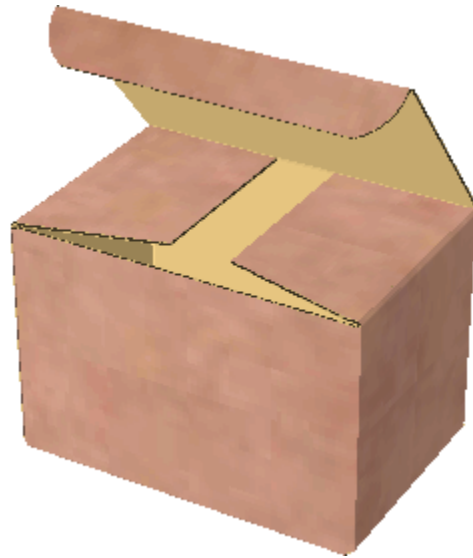
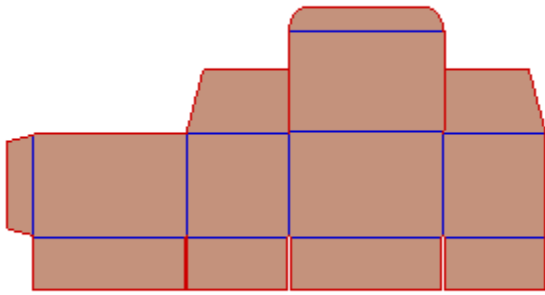

Overlap Seal ends

OT111002

Straight line

Corrugated

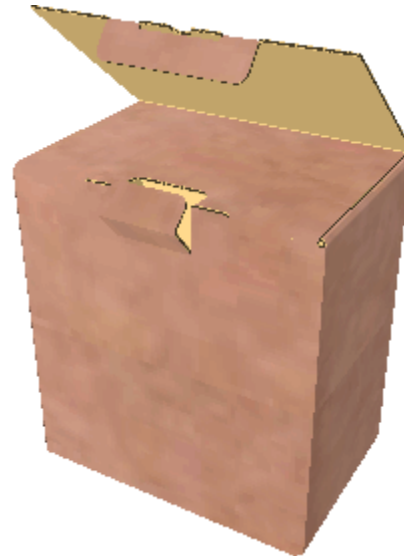
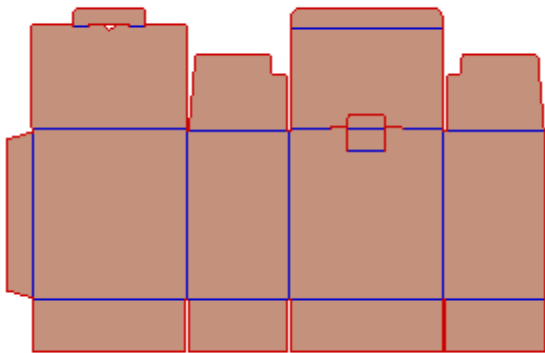

Overlap Seal ends

OT111010

Straight line

Corrugated

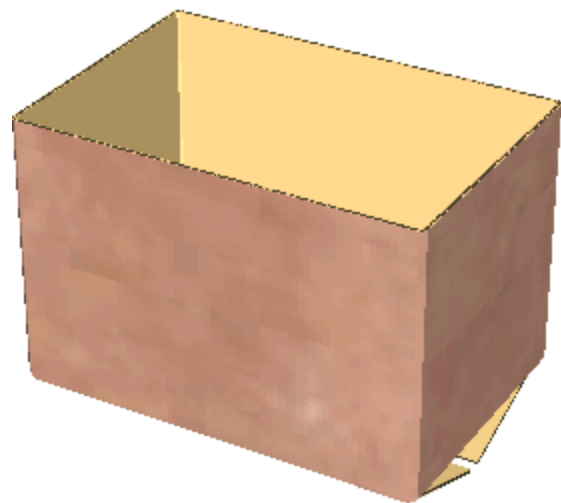
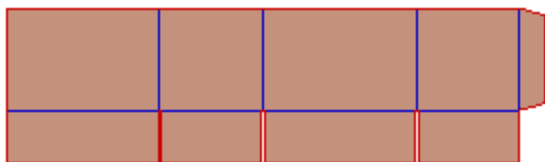

Overlap Seal ends

OT113000_01

Straight line

Corrugated

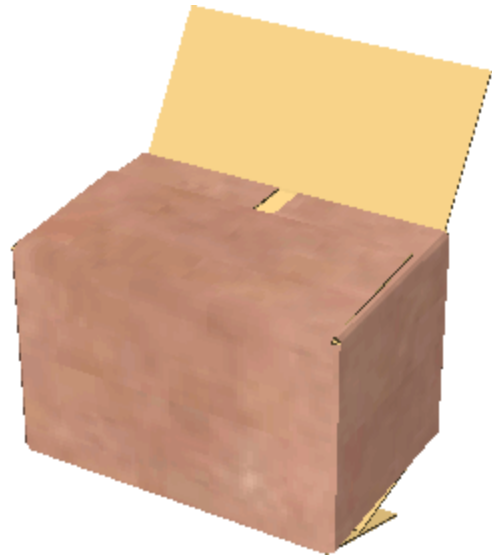
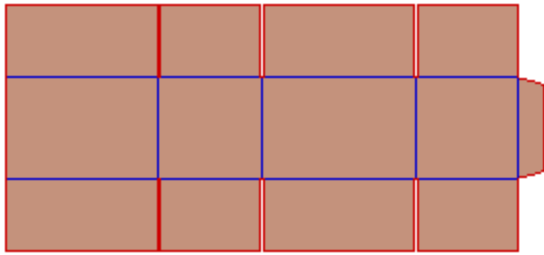

Overlap Seal ends

OT113002_01

Straight line

Corrugated

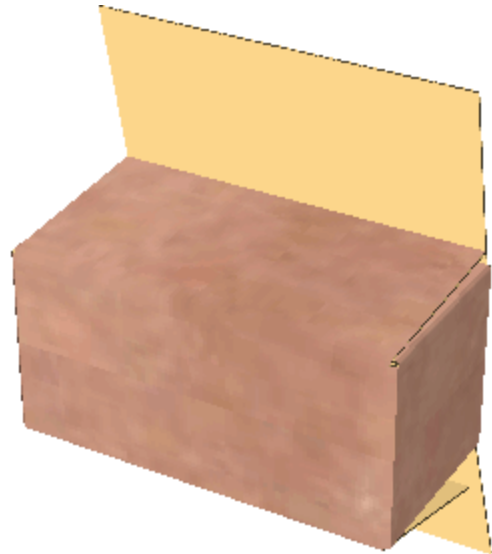
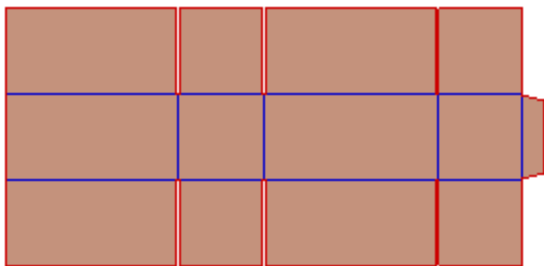

Overlap Seal ends

OT113003_01

Straight line

Corrugated

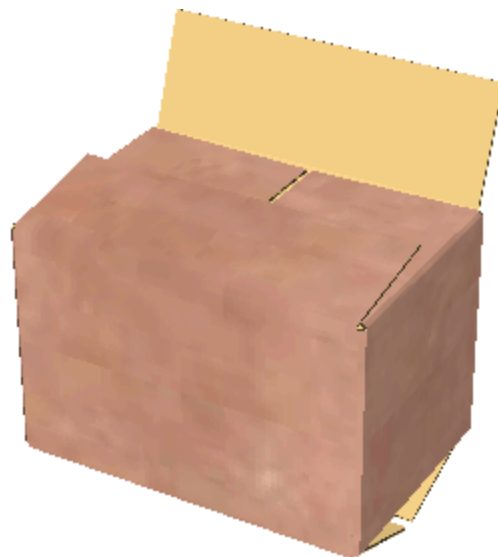
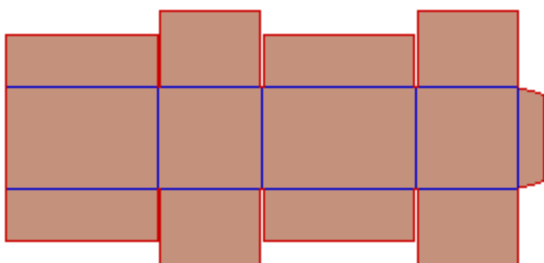

Overlap Seal ends

OT113004_01

Straight line

Corrugated

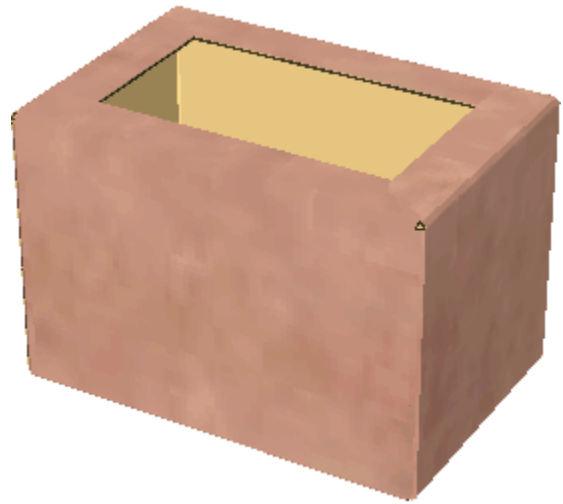
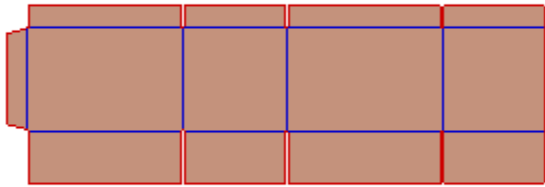

Overlap Seal ends

OT113005

Straight line

Corrugated

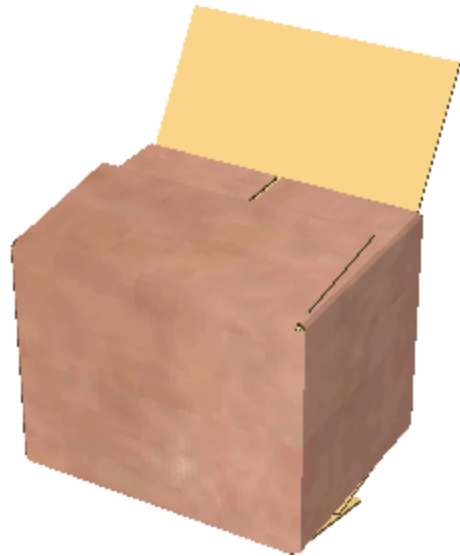
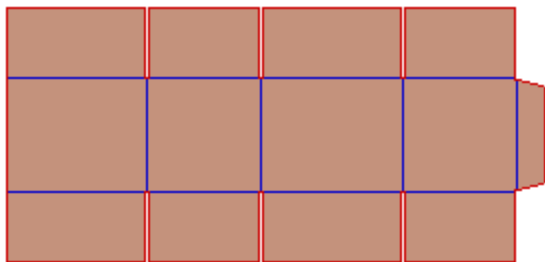

Overlap Seal ends

OT113006

Straight line

Corrugated

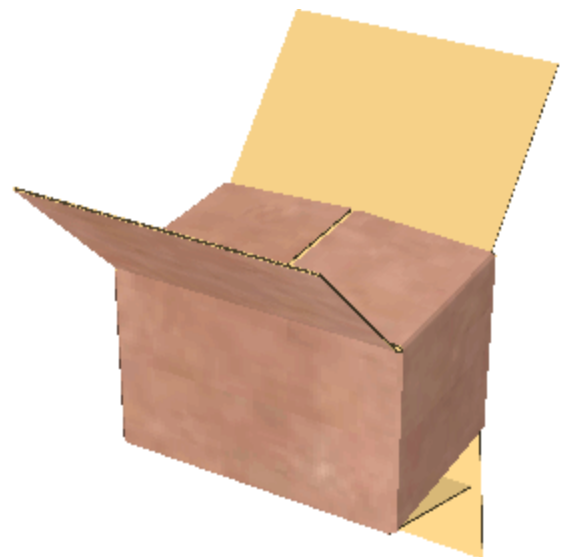
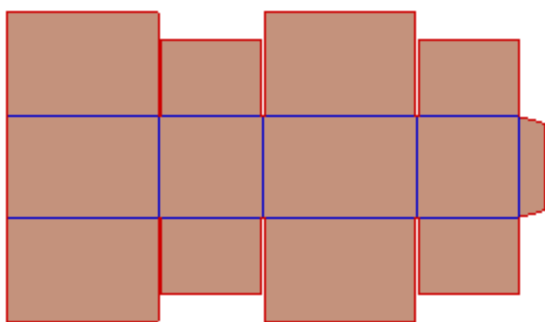

Overlap Seal ends

OT113007

Straight line

Corrugated

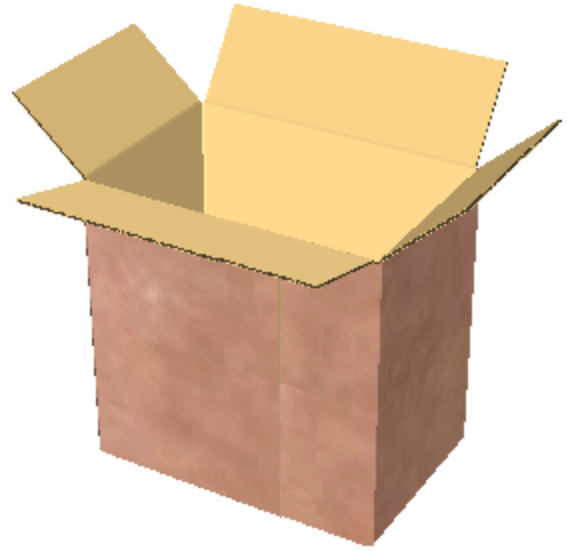
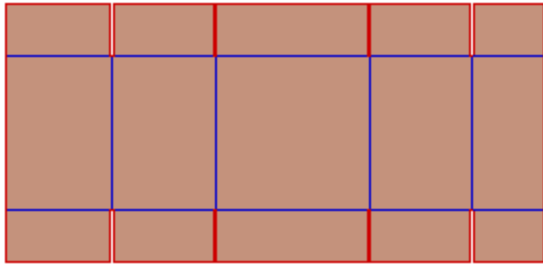

Overlap Seal ends

OT113009

Straight line

Corrugated

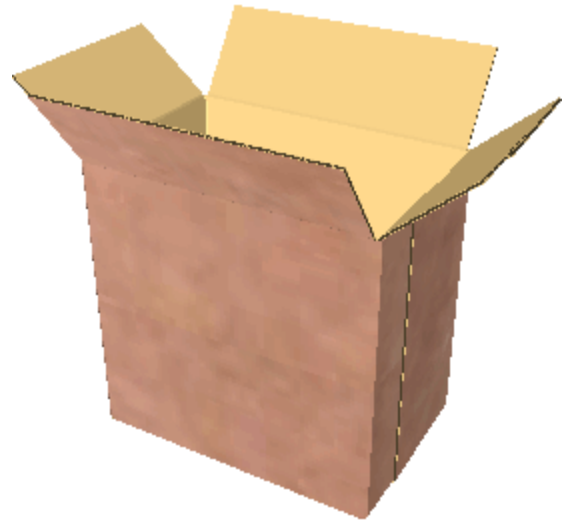
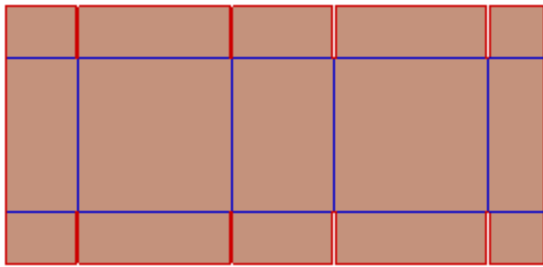

Overlap Seal ends

OT113010

Straight line

Corrugated

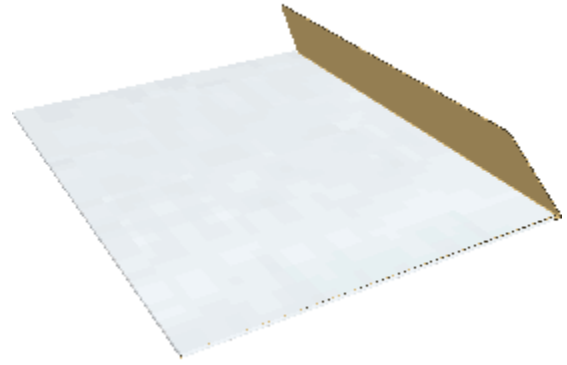
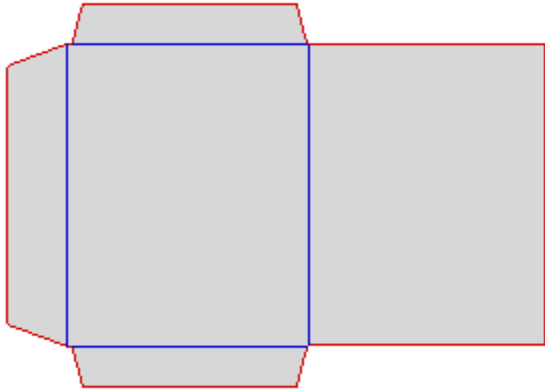

Envelopes

LT120100

Straight line

Compact & E flute

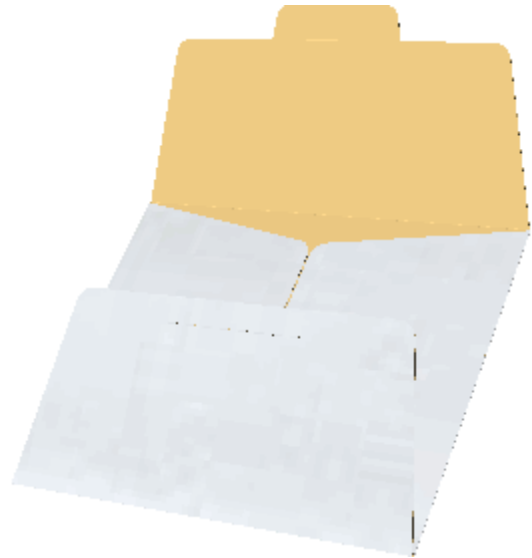
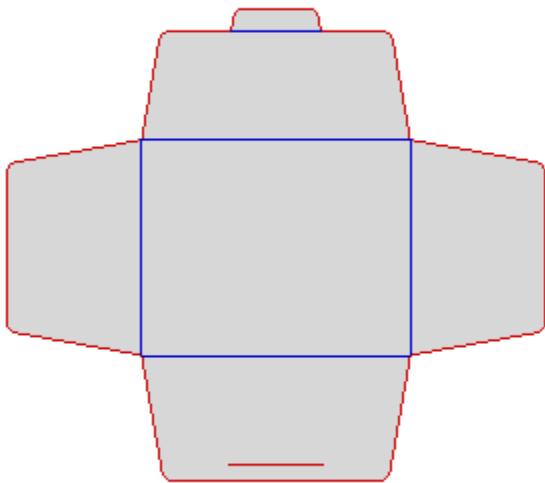

Envelopes

LT120101

Glue free

Compact

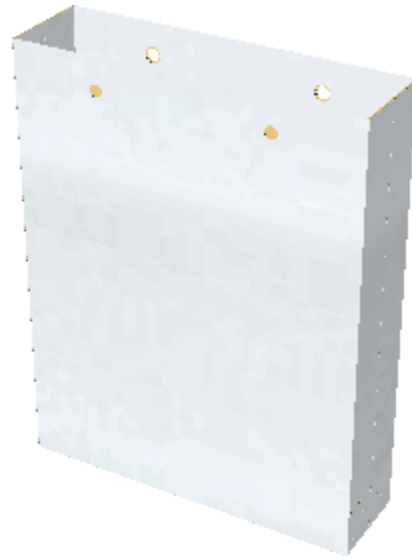
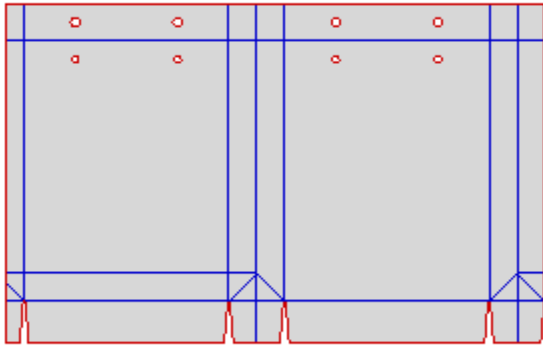

Bags

LT130101

Compact & E flute

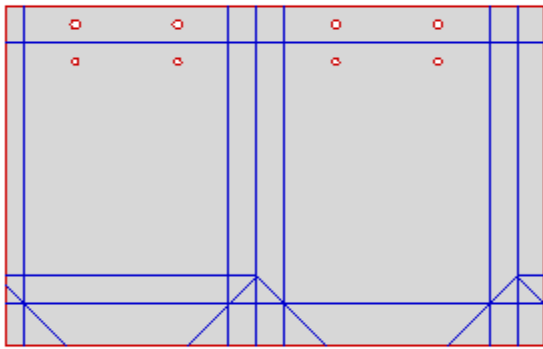

Bags

LT130100

Compact & E flute

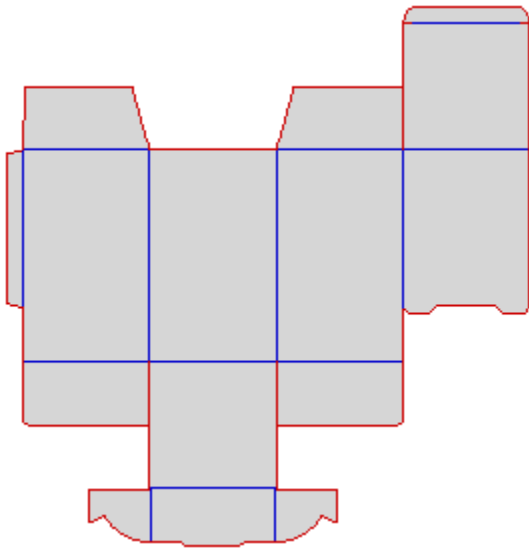

LT140001

Straight line

Compact & E flute

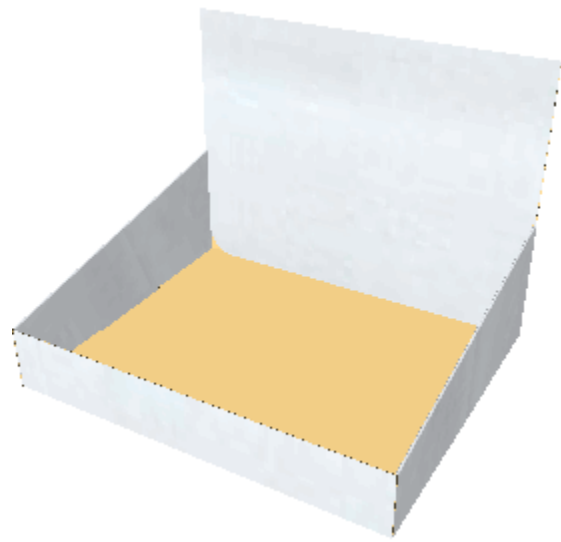
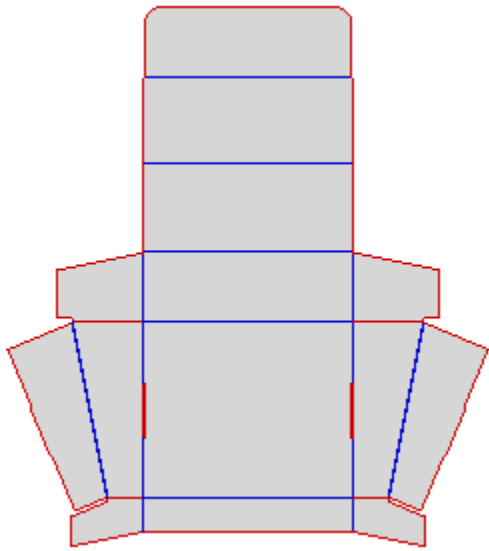

Displays/PLV

LT151102

Glue free

Compact & E flute

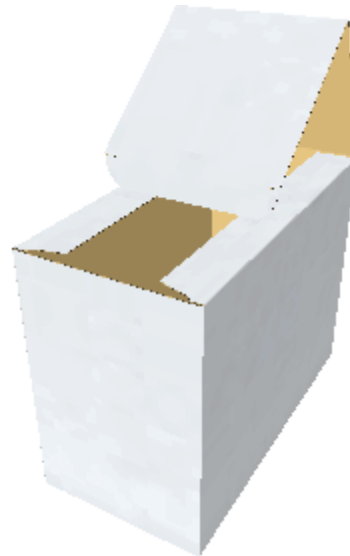
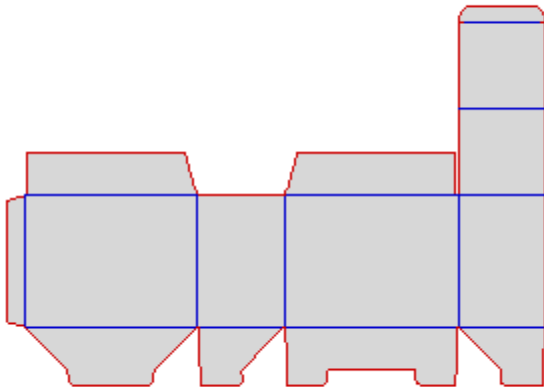

Displays/PLV

LT025101

Straight line

Compact & E flute

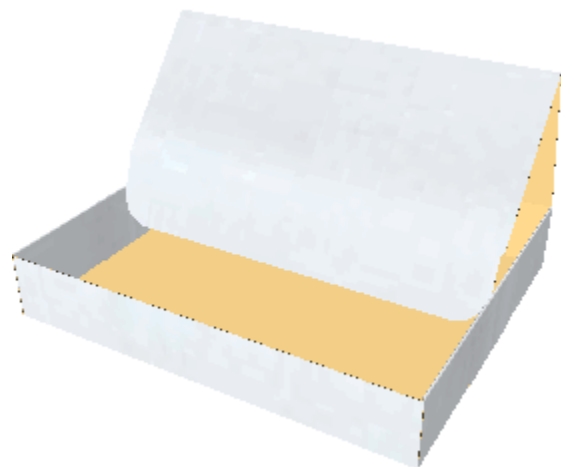
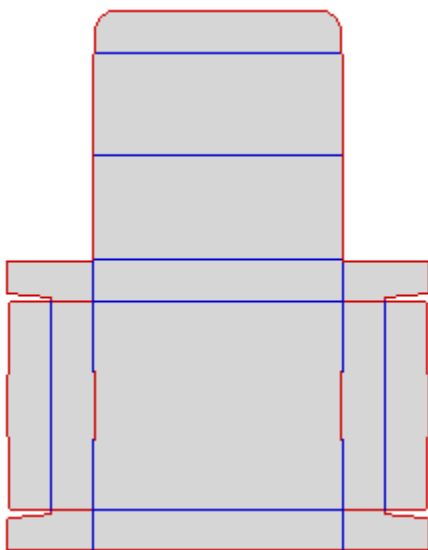

Displays/PLV

LT062101

Glue free

Compact & E flute

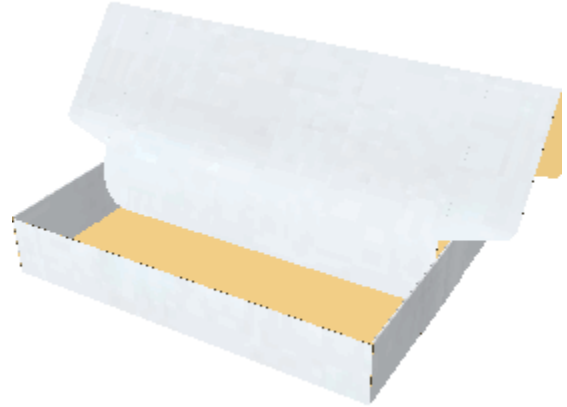
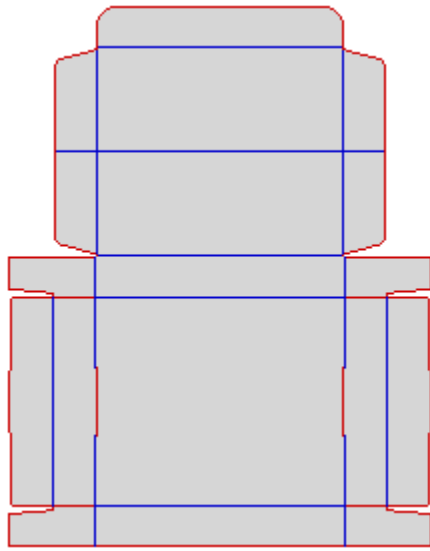

Displays/PLV

LT062104

Glue free

Compact & E flute

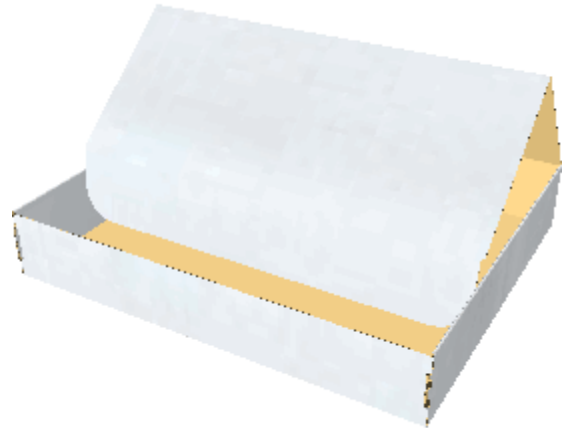
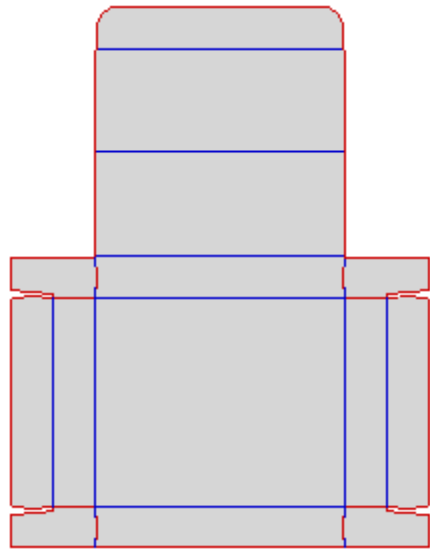

Displays/PLV

LT062102

Glue free

Compact & E flute

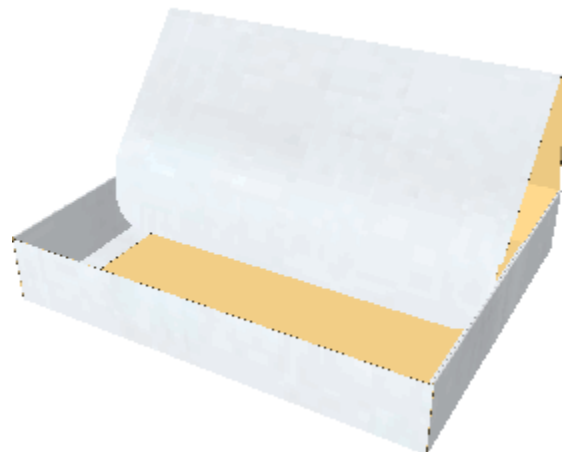
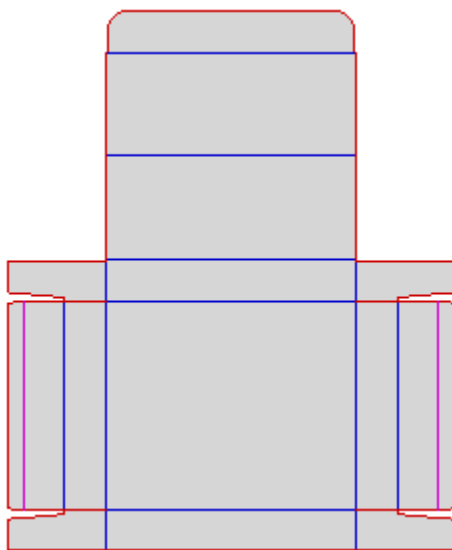

Displays/PLV

LT062103

Glue free

Compact & E flute

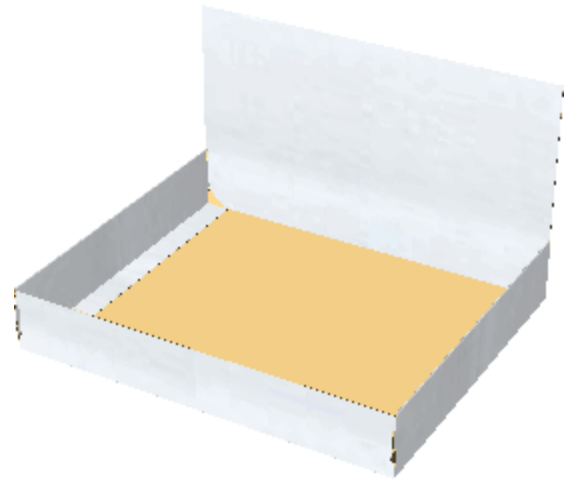
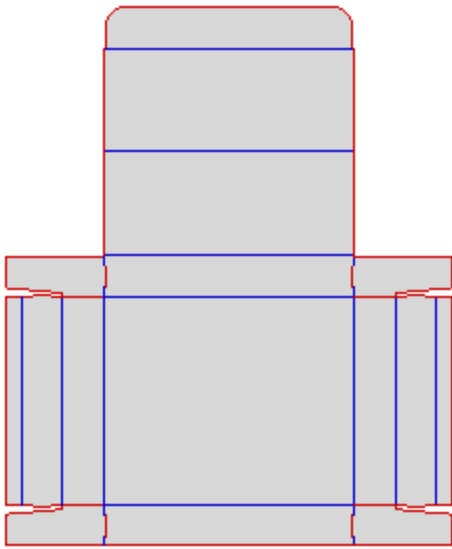

Displays/PLV

LT151093

Glue free

Compact & E flute

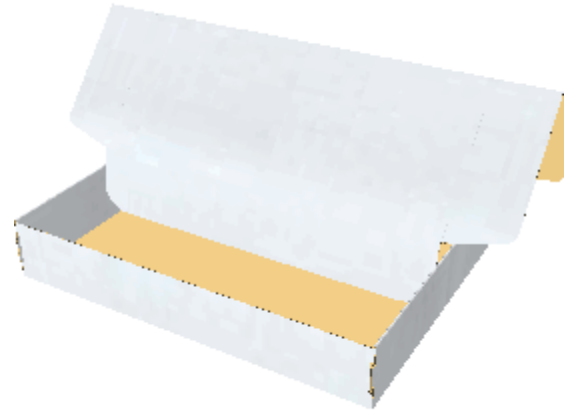
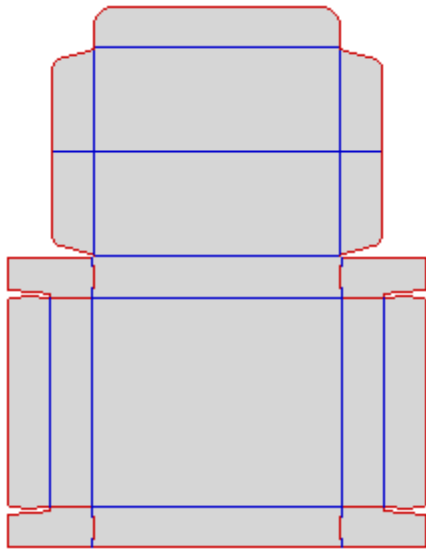

Displays/PLV

LT062105

Glue free

Compact & E flute

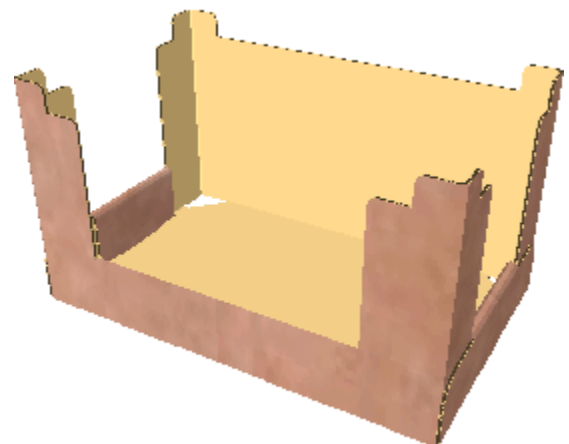
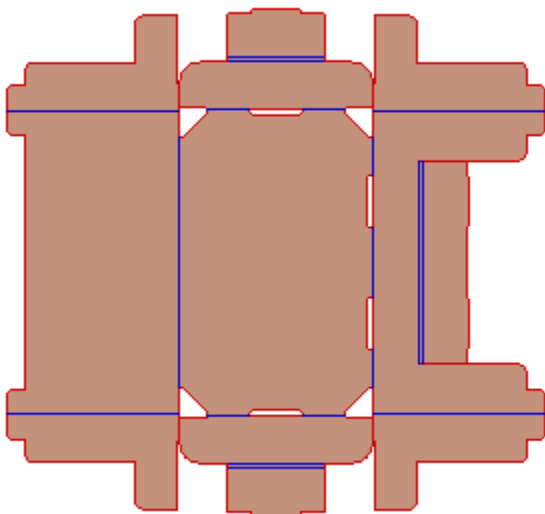

Displays/PLV

OT150120_01

Glue free

Corrugated

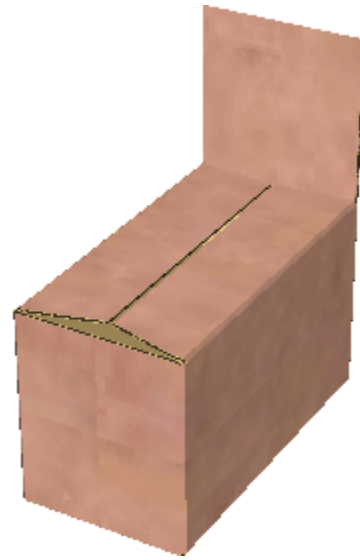
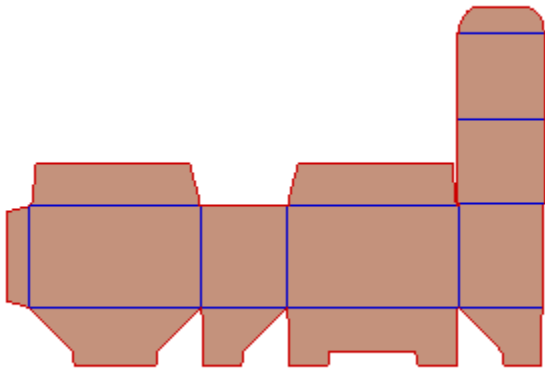

Displays/PLV

OT020105

Straight line

Corrugated

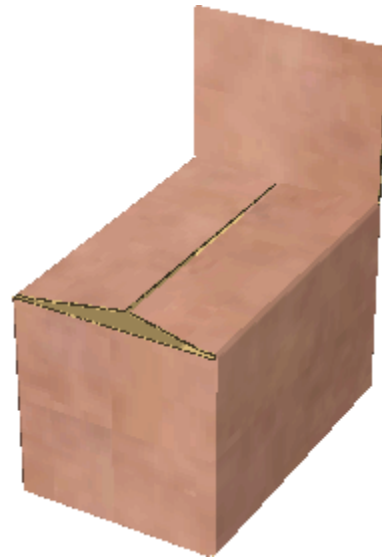
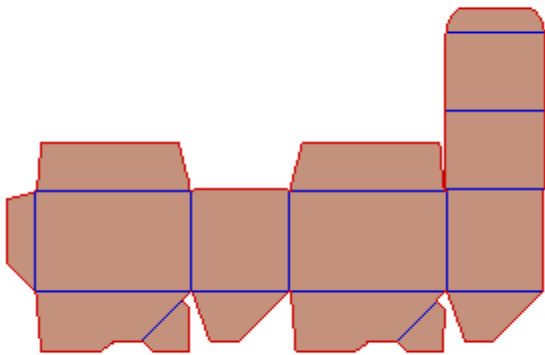

Displays/PLV

OT030121

Corrugated

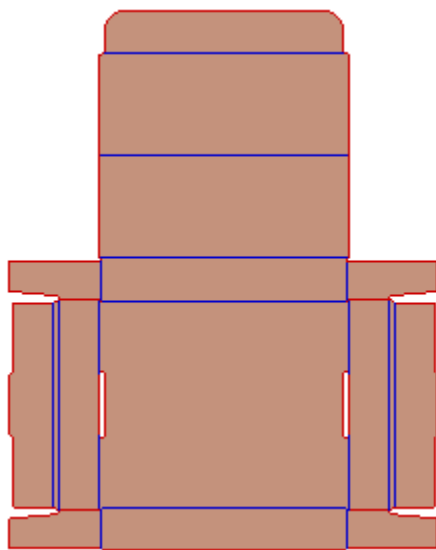

Displays/PLV

OT062101

Glue free

Corrugated

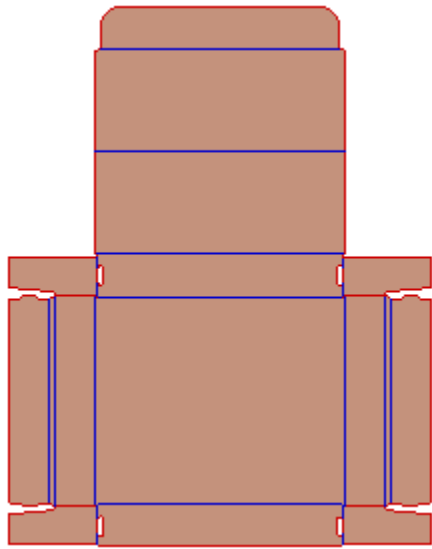

Displays/PLV

OT062102

Glue free

Corrugated

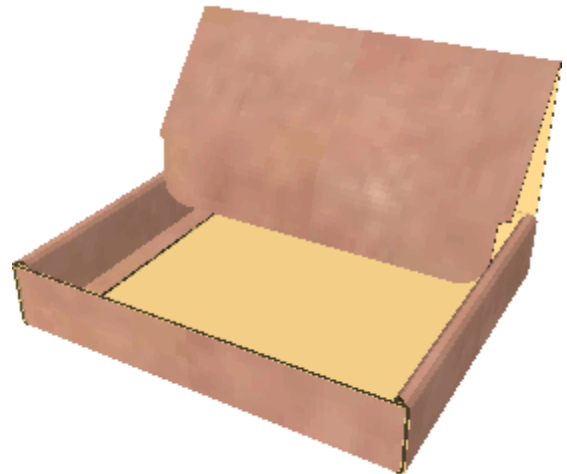
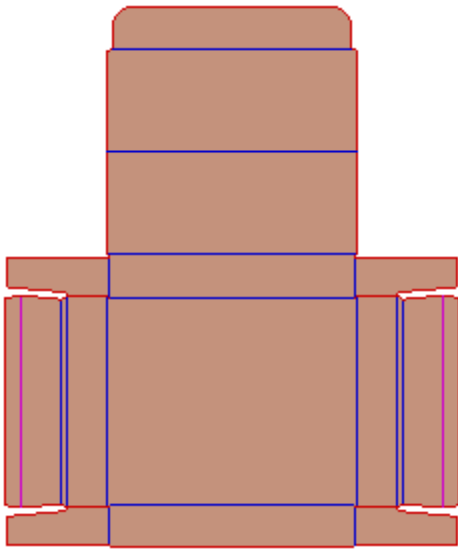

Displays/PLV

OT062103

Glue free

Corrugated

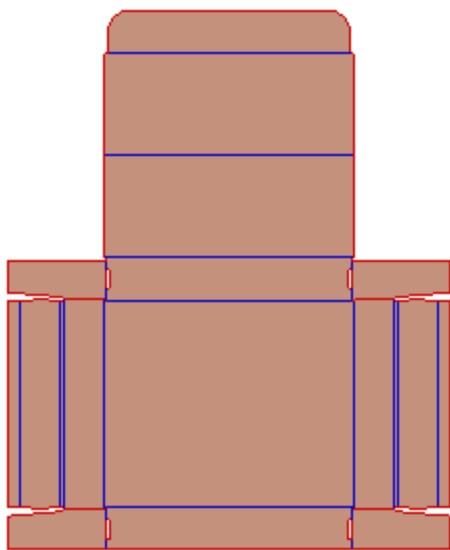

Displays/PLV

OT151093

Glue free

Corrugated

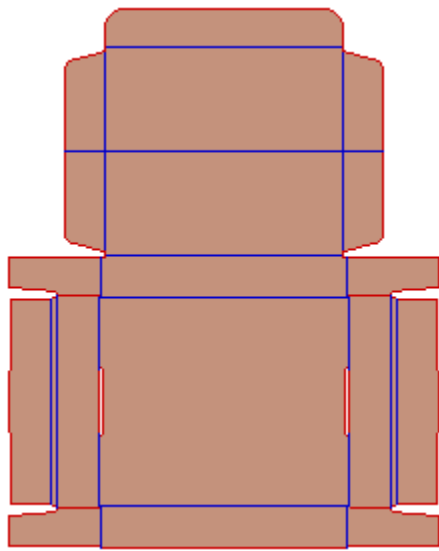

Displays/PLV

OT062104

Glue free

Corrugated

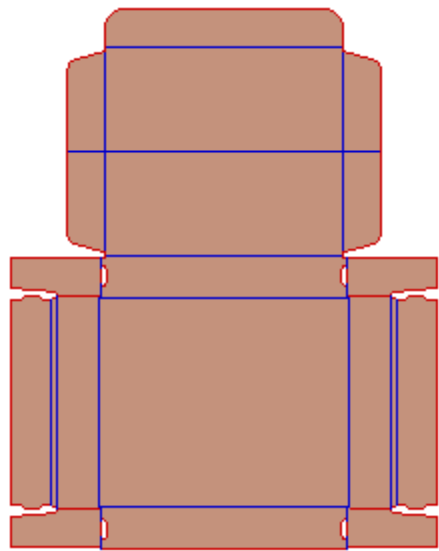

Displays/PLV

OT062105

Glue free

Corrugated

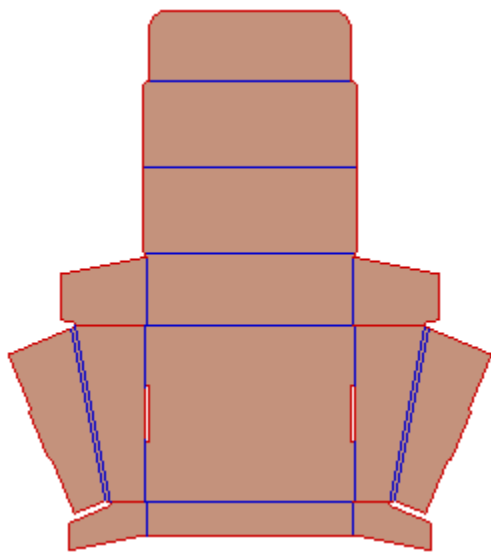

Displays/PLV

OT151102

Glue free

Corrugated

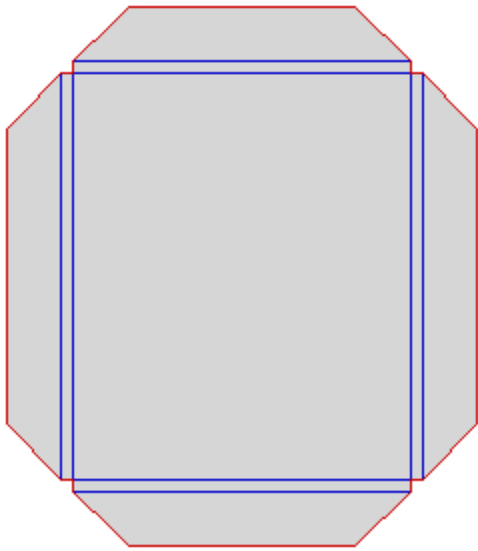

Displays

LT160001

Hand glued

Compact & E flute

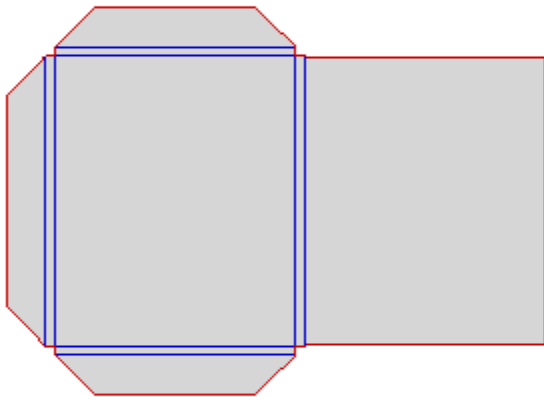

Displays

LT160002

Hand glued

Compact & E flute

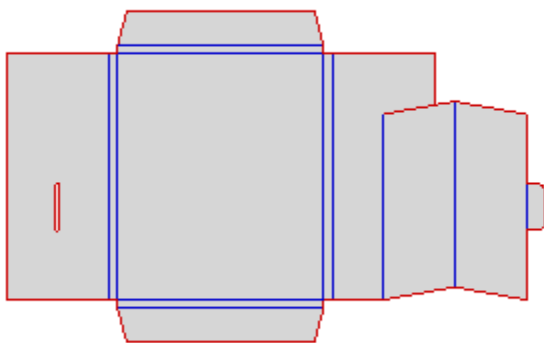

Displays

LT160003

Hand glued

Compact & E flute

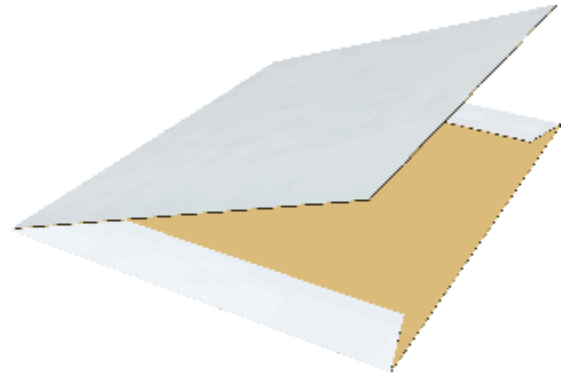
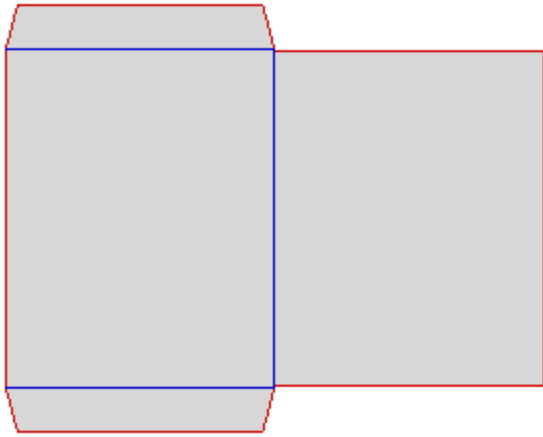

CDS

LT170100

Straight line

Compact & E flute

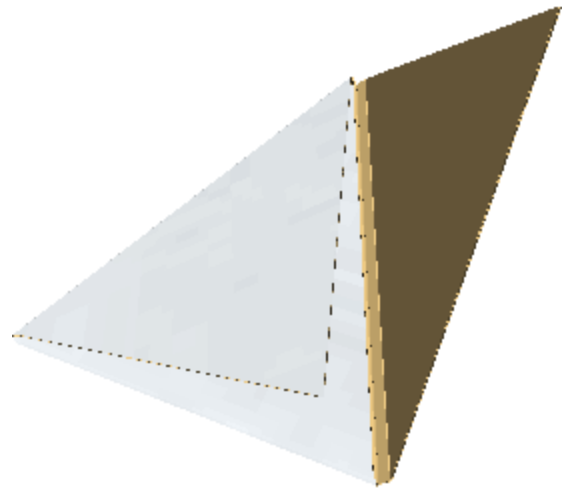
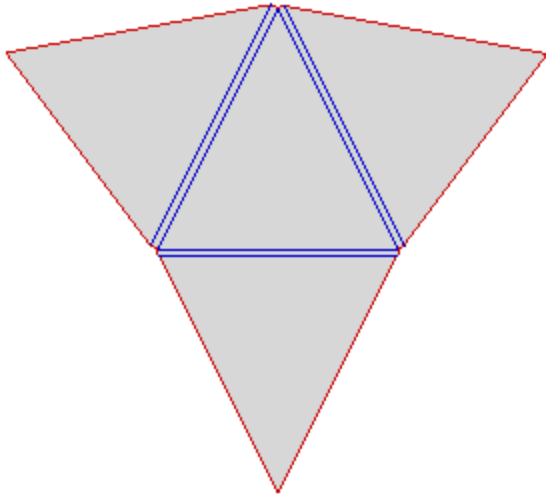

LT180011

Glue free

Compact & E flute

Promotions / Gifts

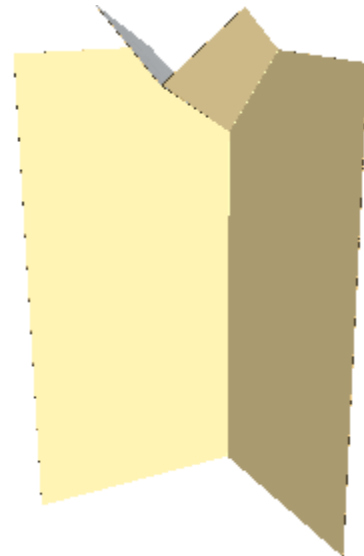
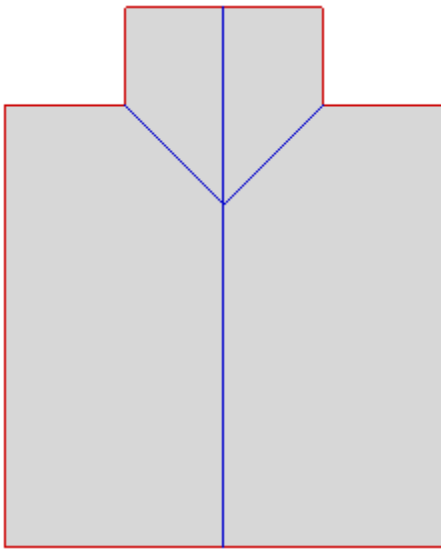

LT180004

Glue free

Compact

Promotions / Gifts

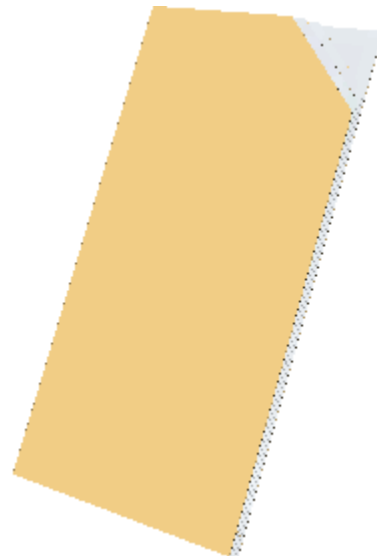
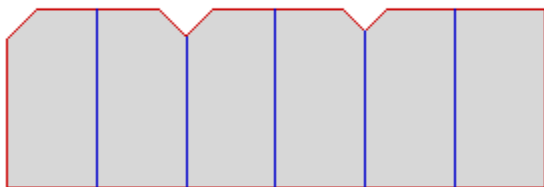

LT180005

Glue free

Compact

Promotions / Gifts

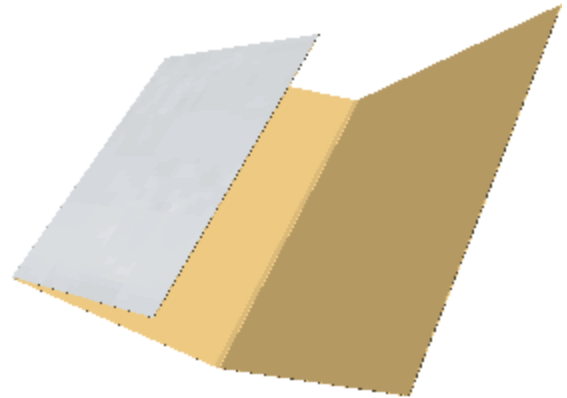
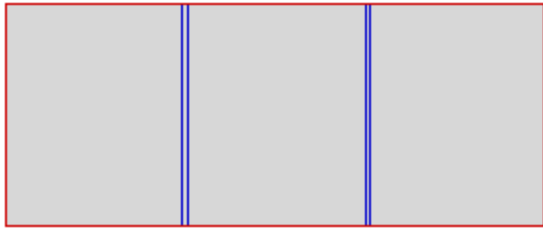

LT180012

Glue free

Compact & E flute

Promotions / Gifts

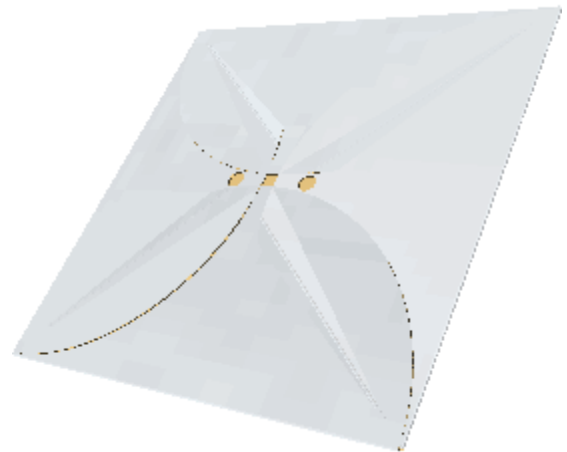
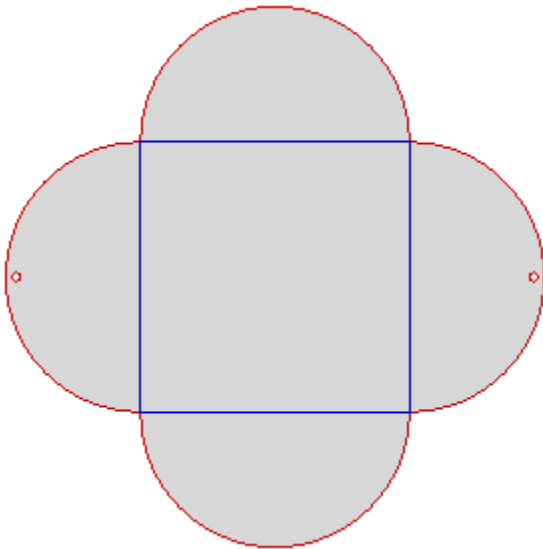

LT180006

Glue free

Compact & E flute

Promotions / Gifts

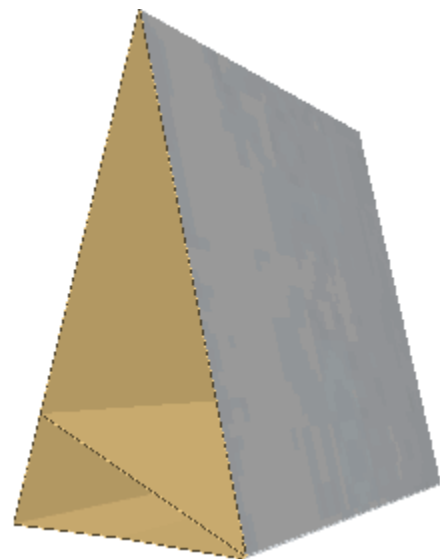

LT180007

Straight line

Compact & E flute

Promotions / Gifts

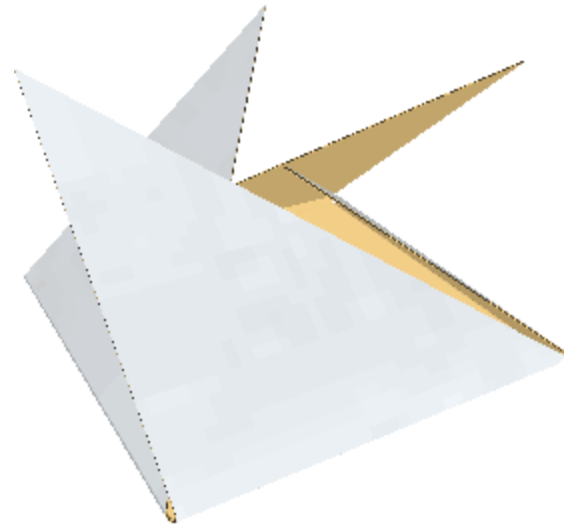
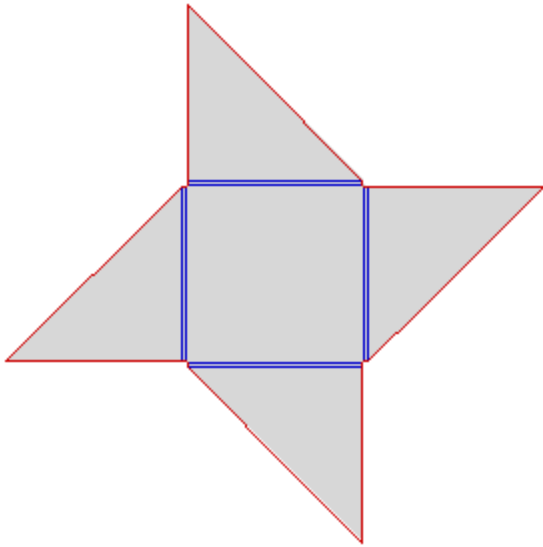

LT180013

Glue free

Compact & E flute

Promotions / Gifts

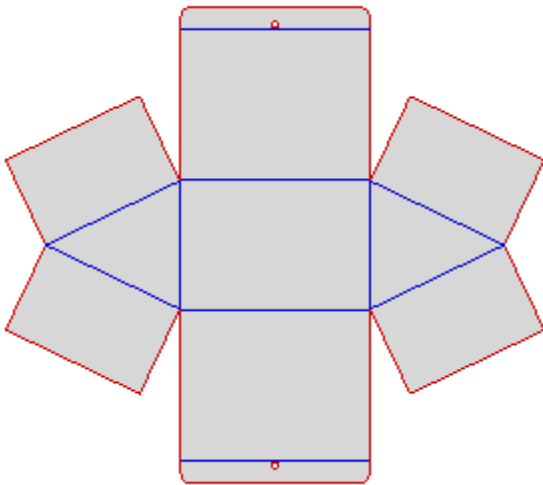

LT180008

Glue free

Compact

Promotions / Gifts

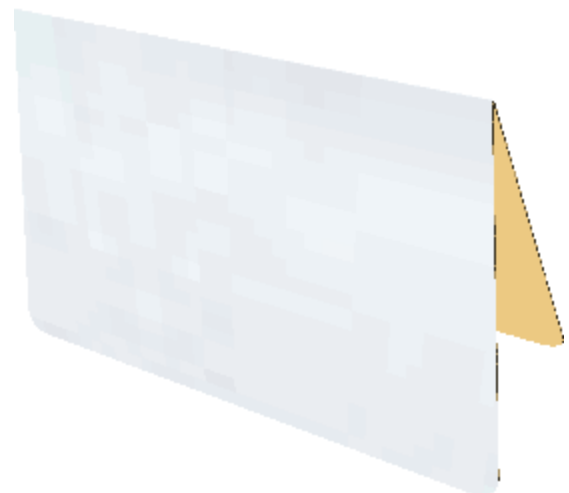
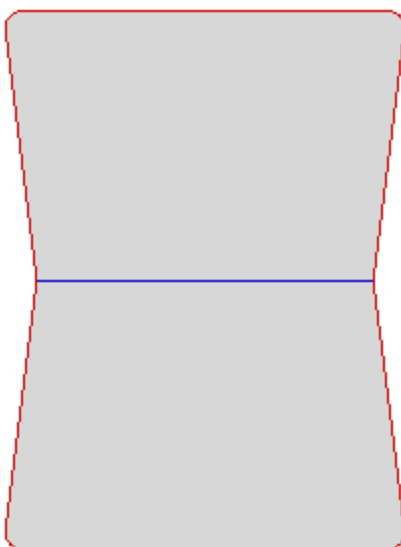

LT180014

Glue free

Compact & E flute

Promotions / Gifts

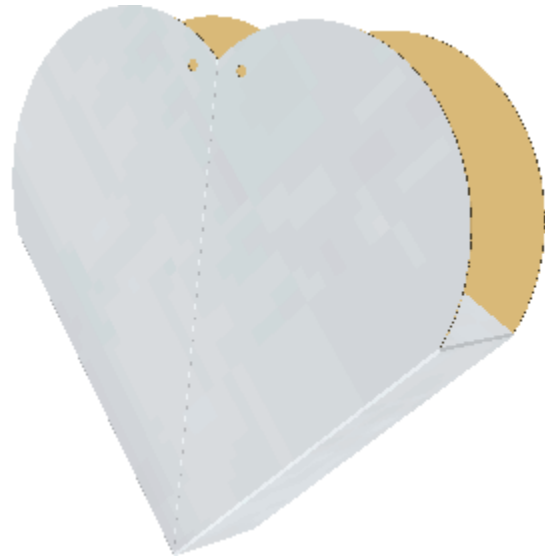
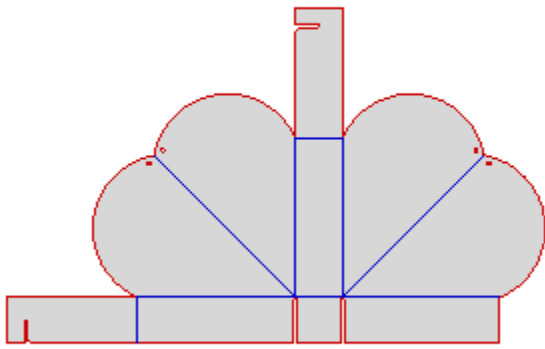

Promotions / Gifts

LT180009

Hand glued

Compact

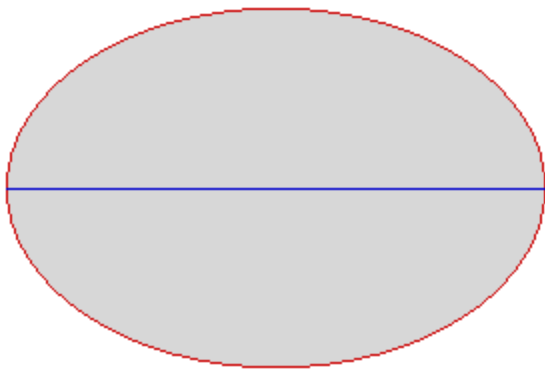

Promotions / Gifts

LT180015

Glue free

Compact & E flute

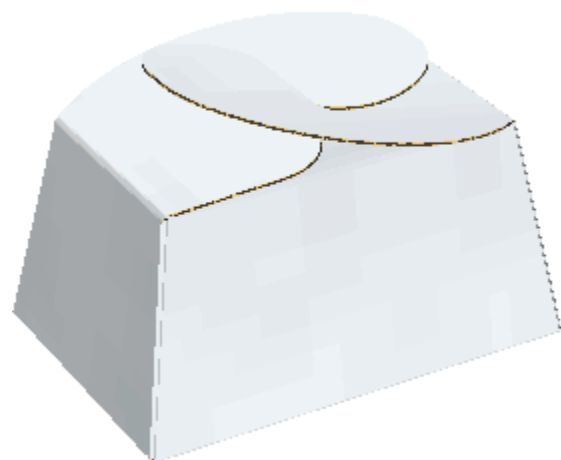
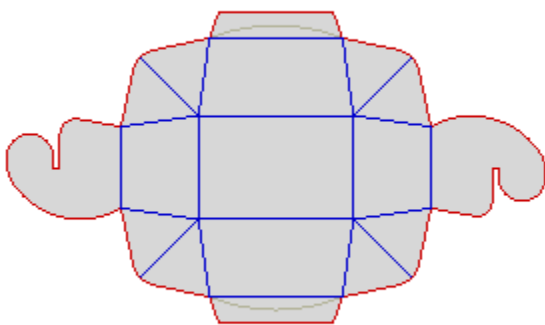

Promotions / Gifts

LT180010

Glue free

Compact

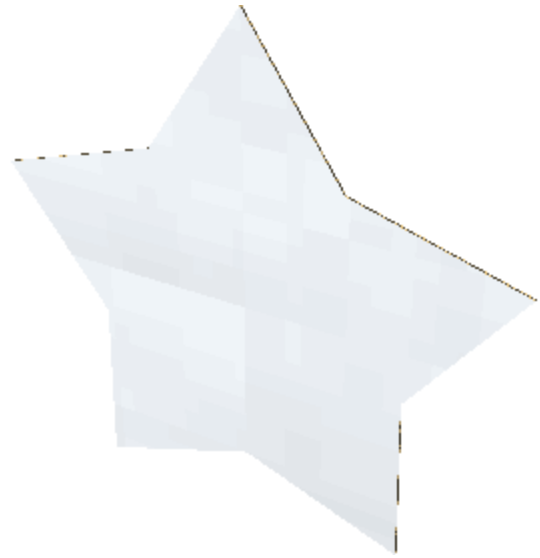
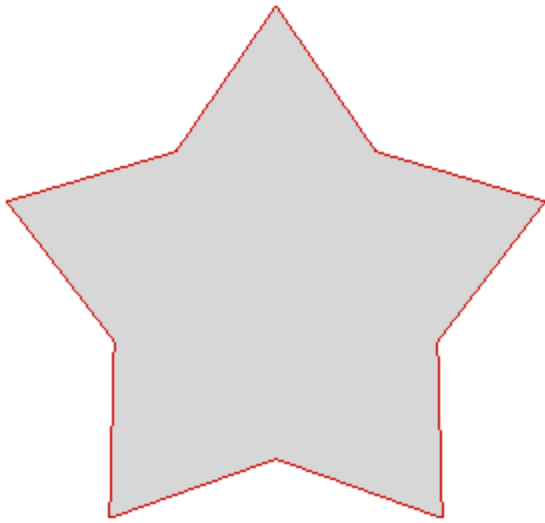

Promotions / Gifts

LT180016

Glue free

Compact & E flute

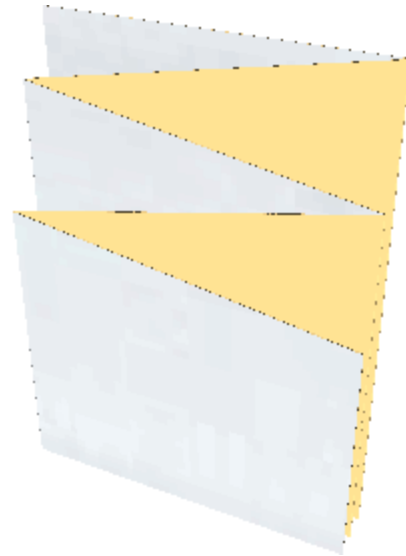
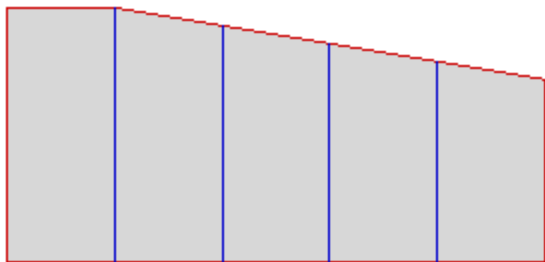

Promotions / Gifts

LT180017

Glue free

Compact & E flute

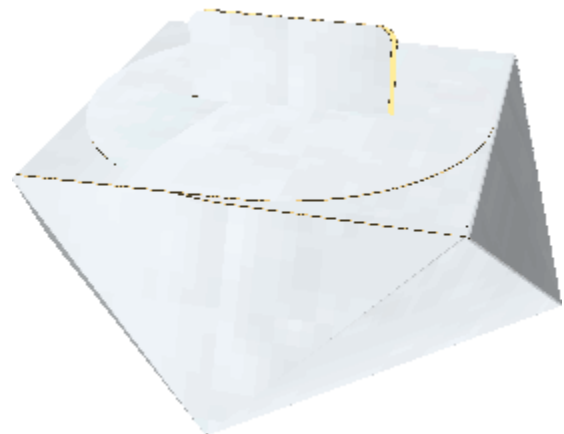
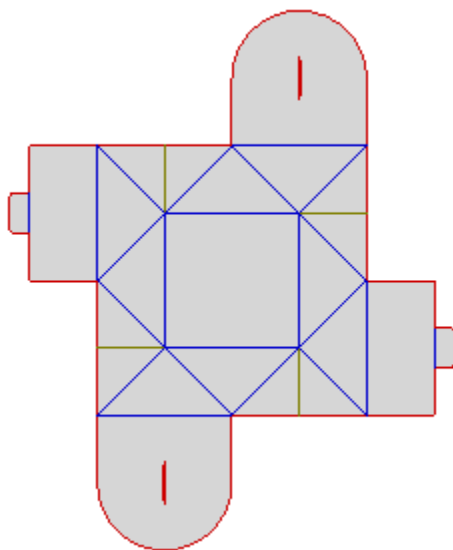

Promotions / Gifts

LT200010

Glue free

Compact & E flute

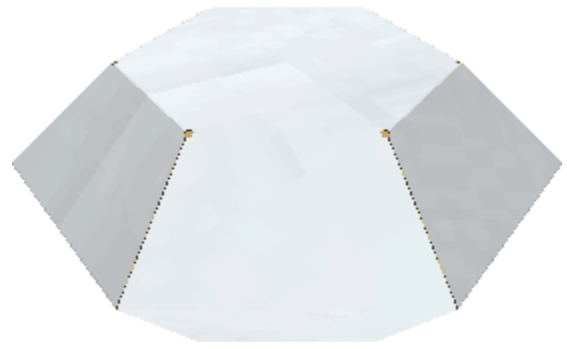
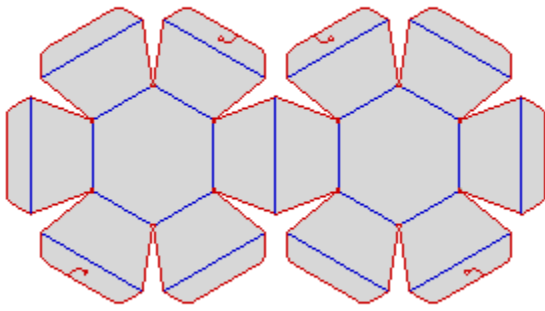

LT200011

Hand glued

Compact & E flute

Promotions / Gifts

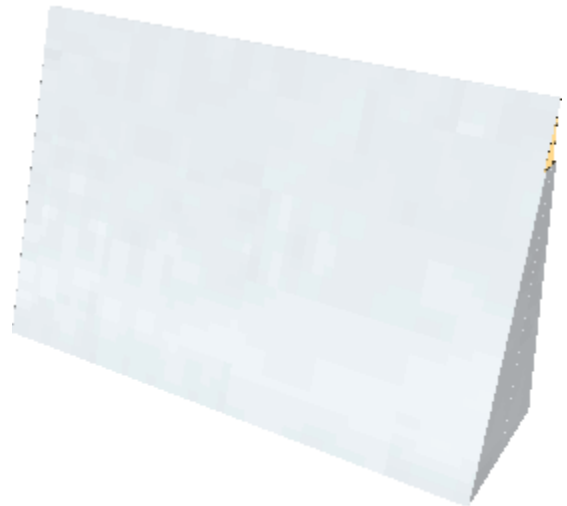
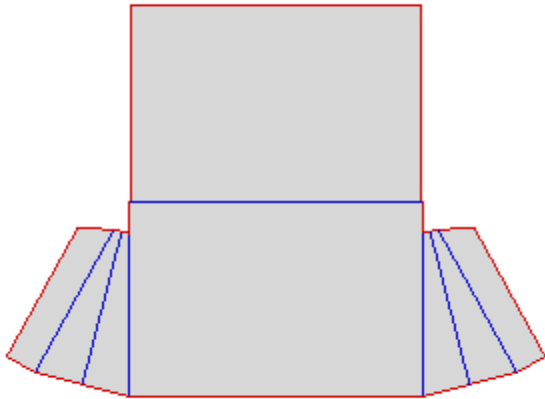

LT180002

Straight line

Compact & E flute

Promotions / Gifts

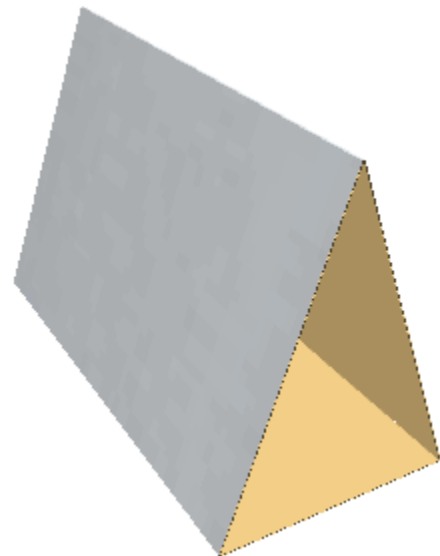
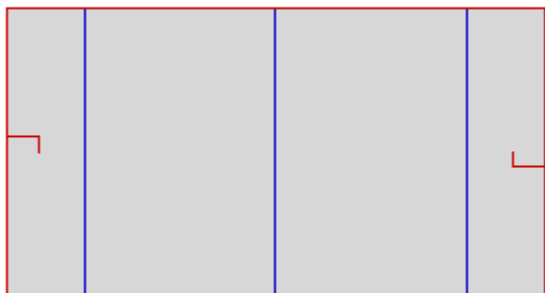

LT180001

Glue free

Compact & E flute

Promotions / Gifts

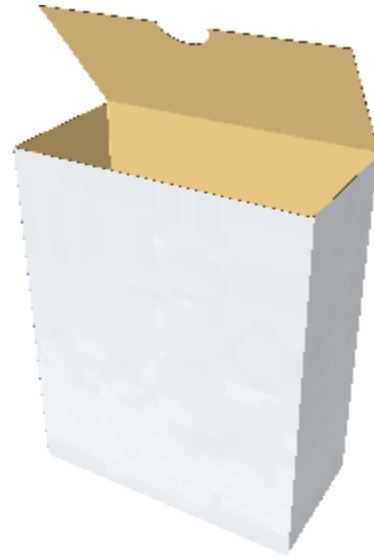
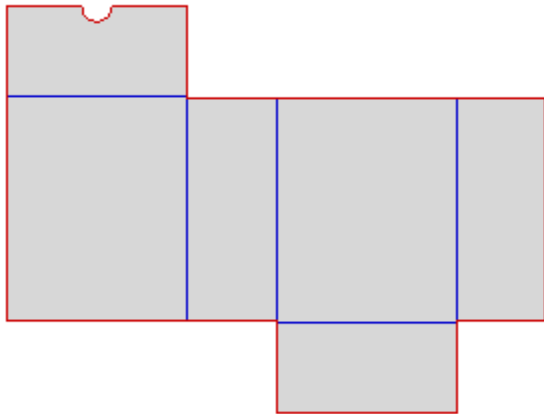

Dividers

LT190100

Glue free

Compact & E flute

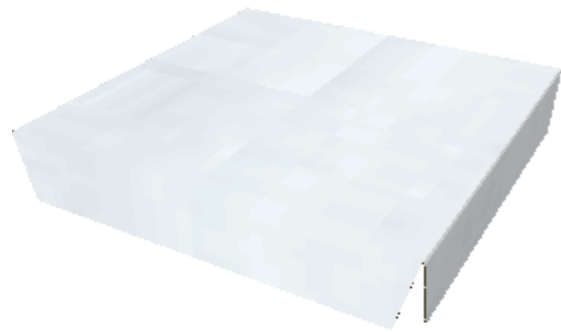
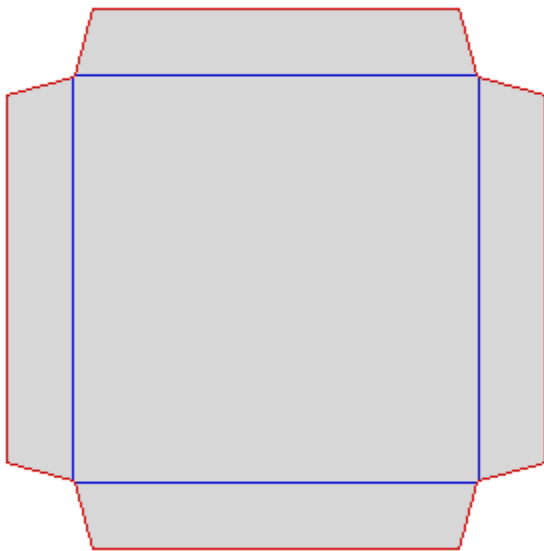

Dividers

LT190001

Glue free

Compact & E flute

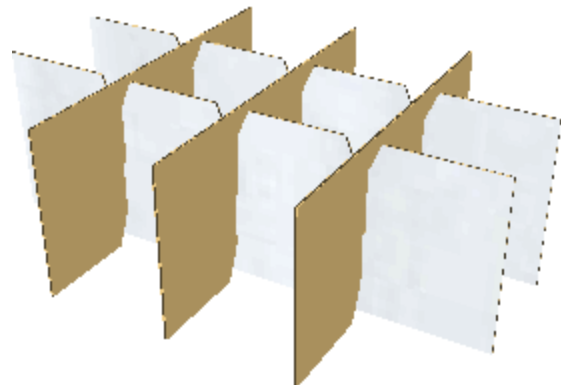
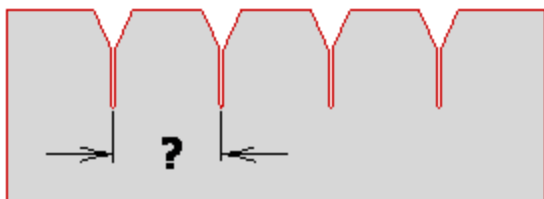
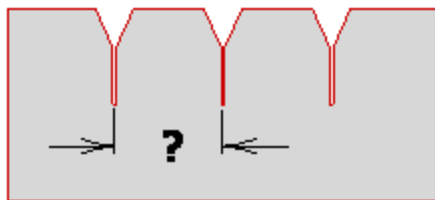

Dividers

LT190400

Glue free

Compact & E flute

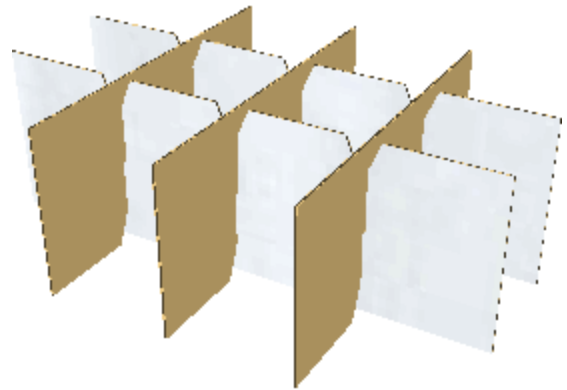
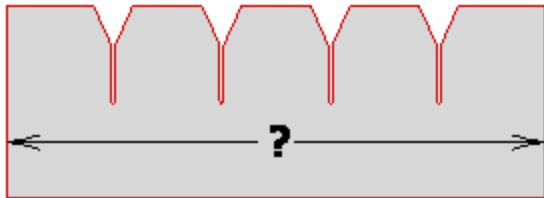
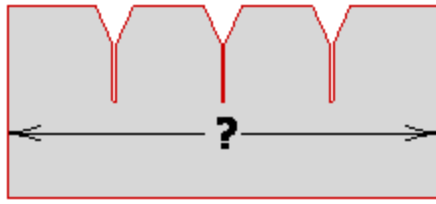

Dividers

LT190402

Glue free

Compact & E flute

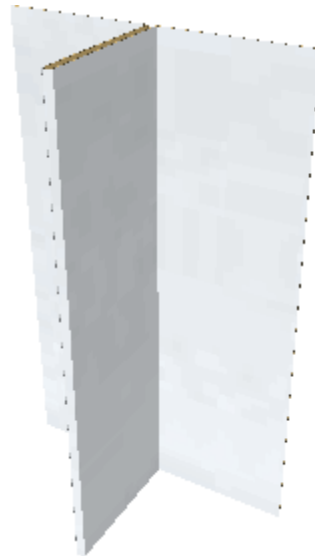
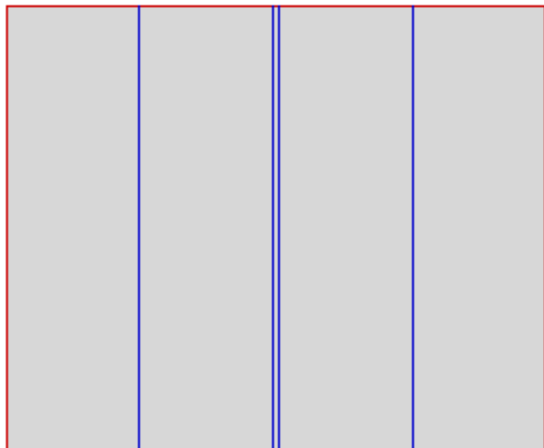

Dividers

LT190202

Glue free

Compact & E flute

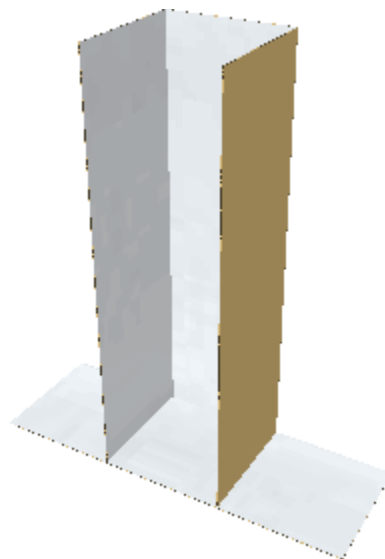
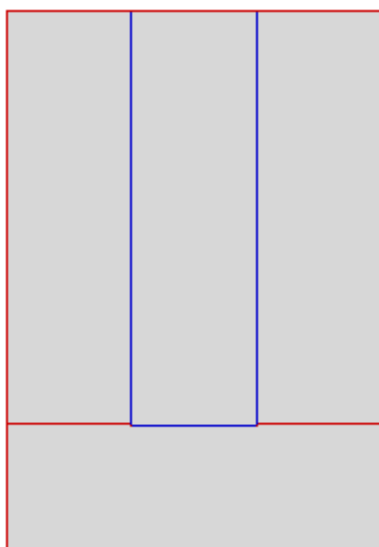

Dividers

LT190301

Glue free

Compact & E flute

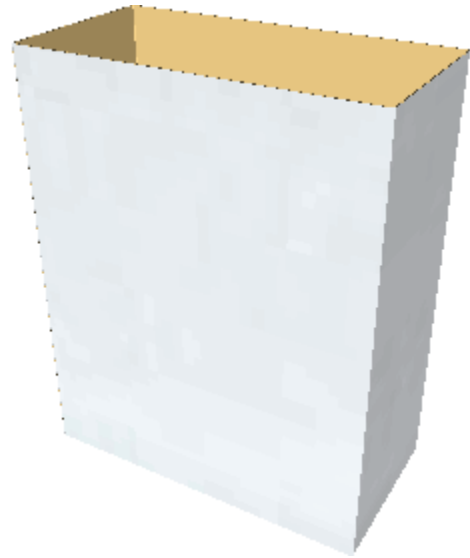
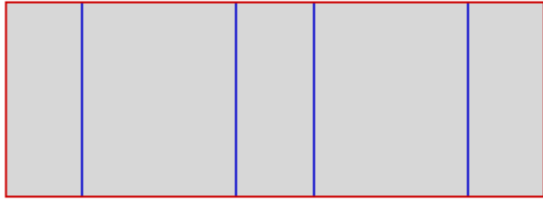

Dividers

LT190203

Glue free

Compact & E flute

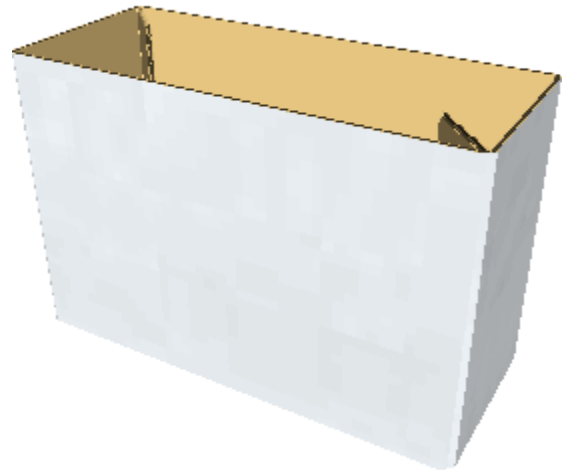
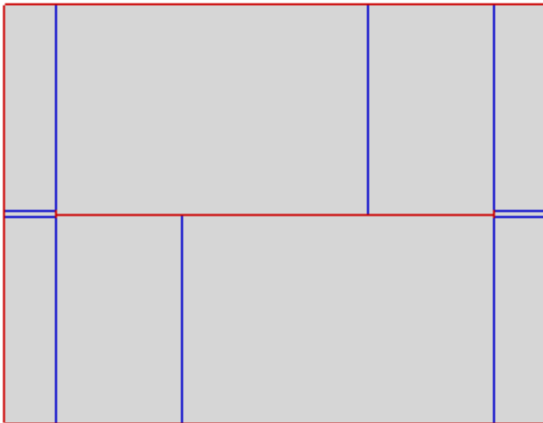

Dividers

LT190204

Glue free

Compact & E flute

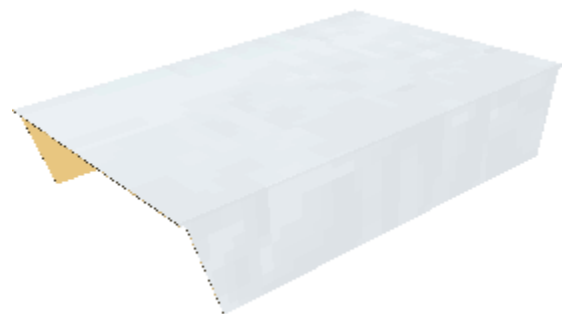
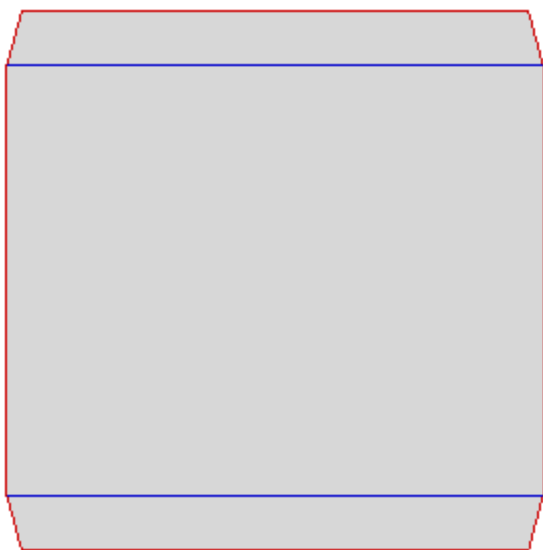

Dividers

LT190003

Glue free

Compact & E flute

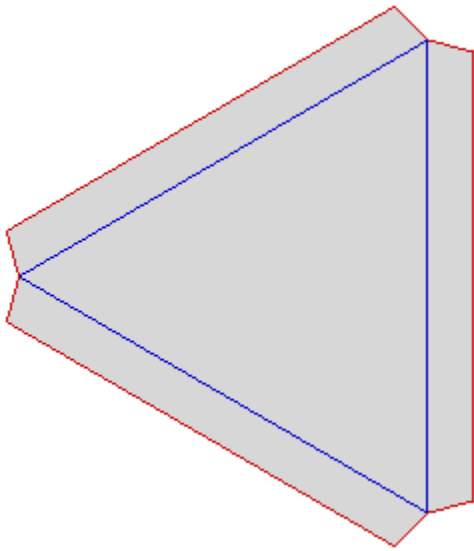

Dividers

LT190002

Glue free

Compact & E flute

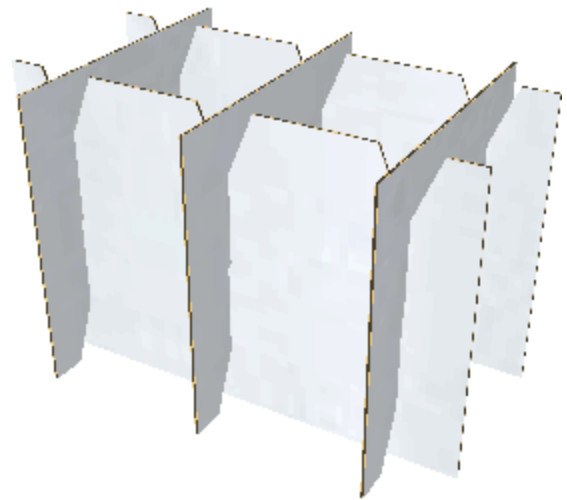
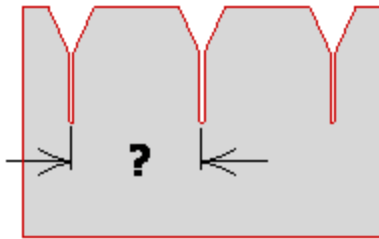

Dividers

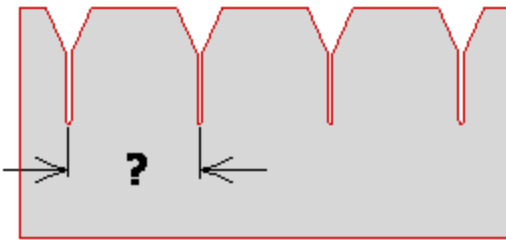

LT190401

Glue free

Compact & E flute

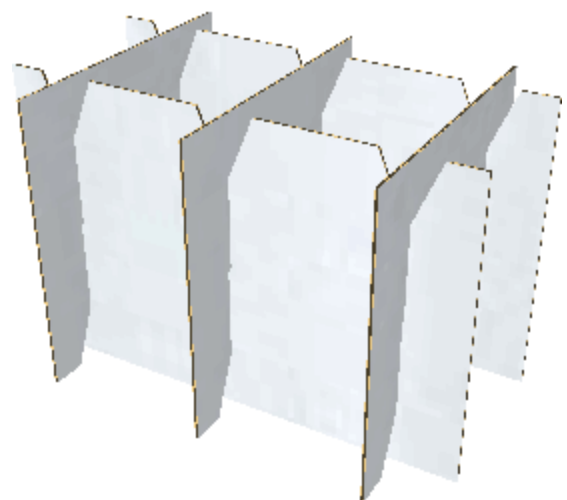
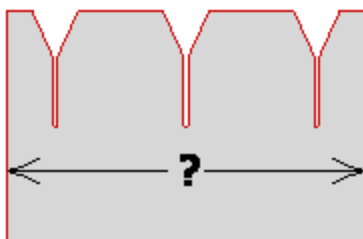

Dividers

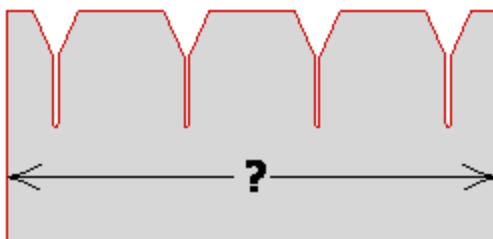

LT190403

Glue free

Compact & E flute

Dividers

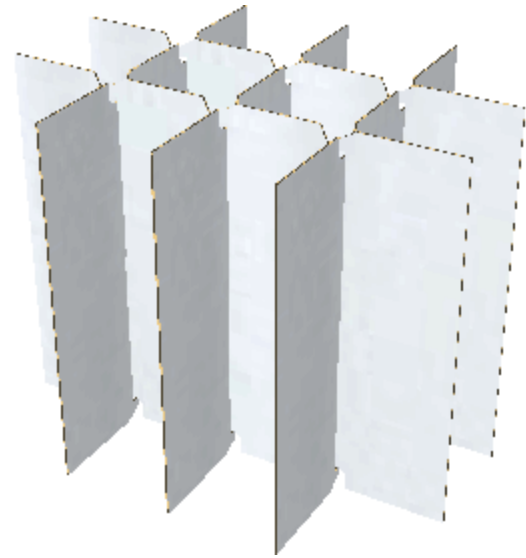
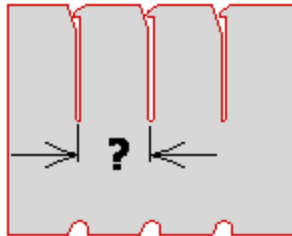
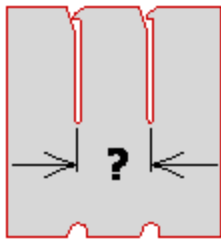

LT190404

Glue free

E flute

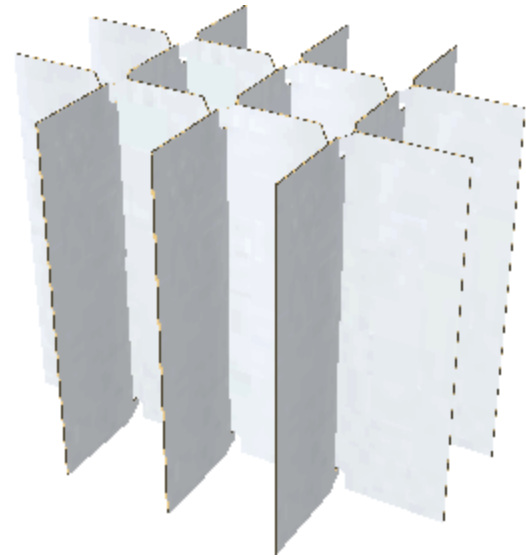
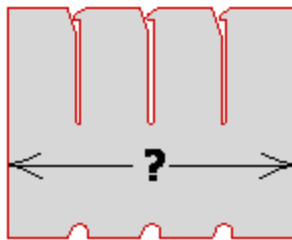
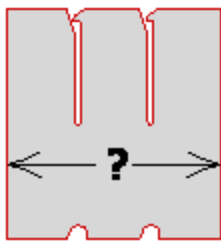

Dividers

LT190405

Glue free

E flute

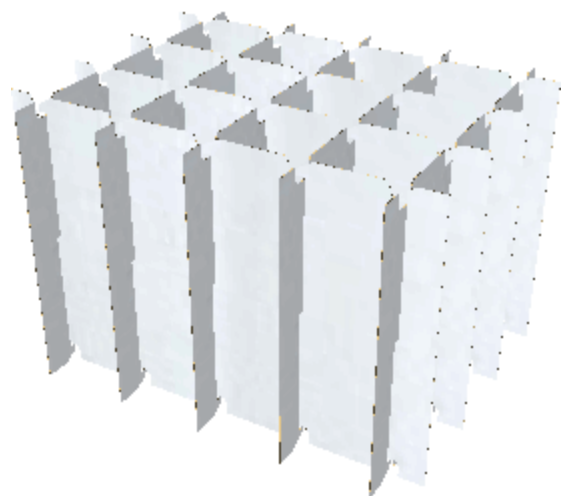
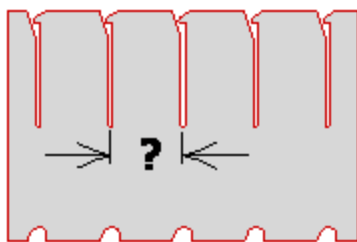
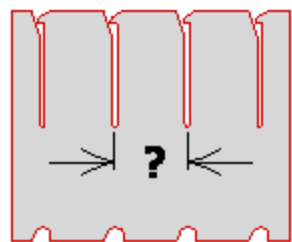

Dividers

LT190406

Glue free

E flute

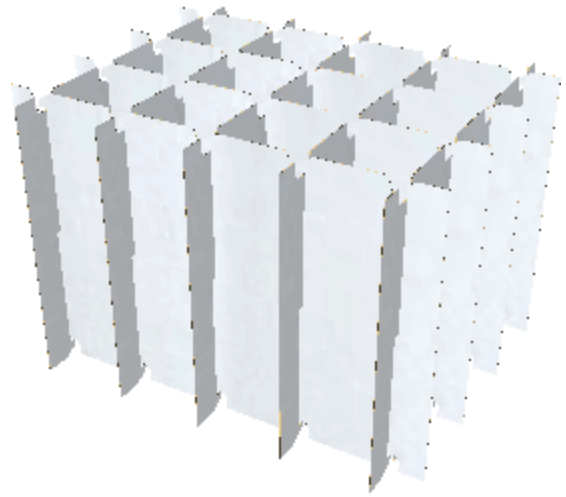
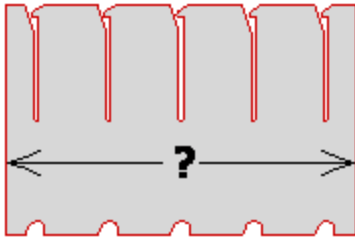
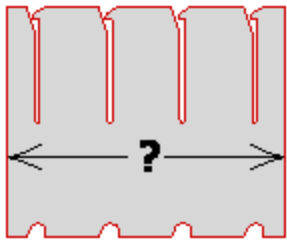

Dividers

LT190407

Glue free

E flute

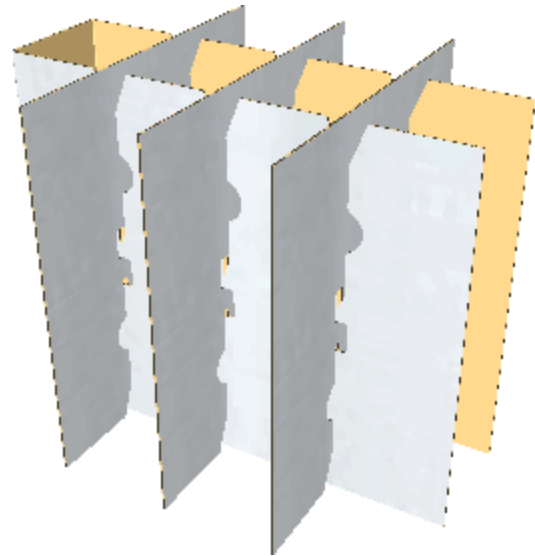
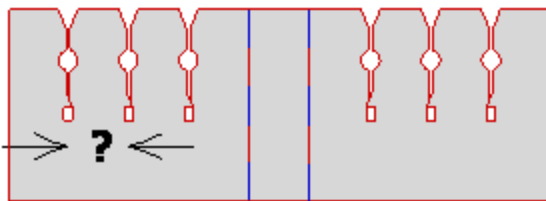
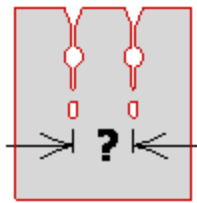

Dividers

LT190408

Glue free

E flute

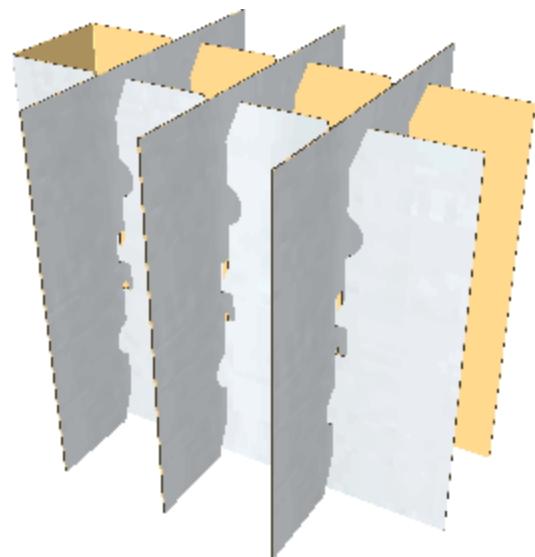
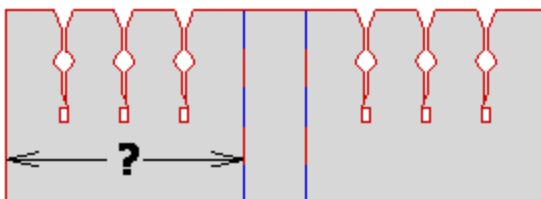
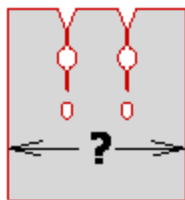

Dividers

LT190409

Glue free

E flute

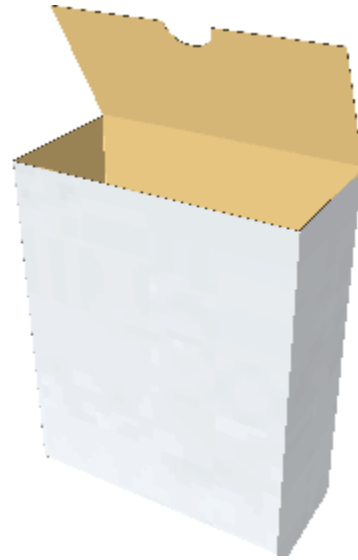
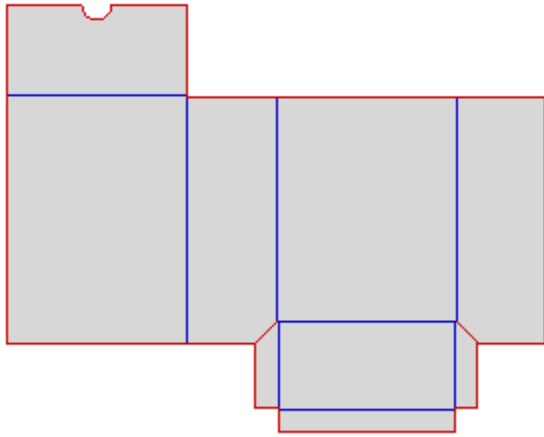

Dividers

LT190101

Glue free

Compact & E flute

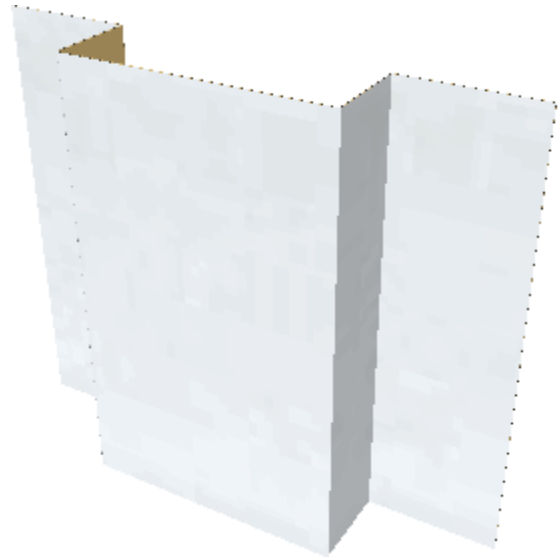
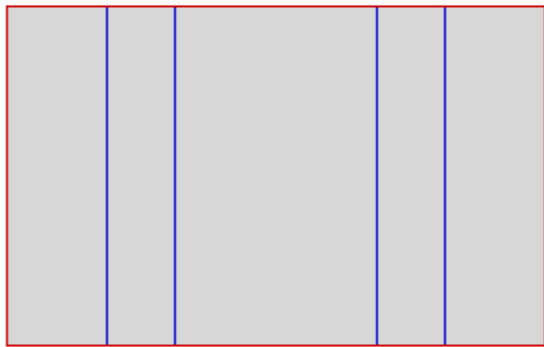

Dividers

LT190201

Glue free

Compact & E flute

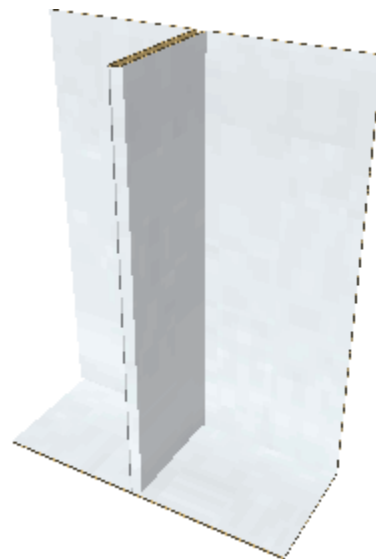
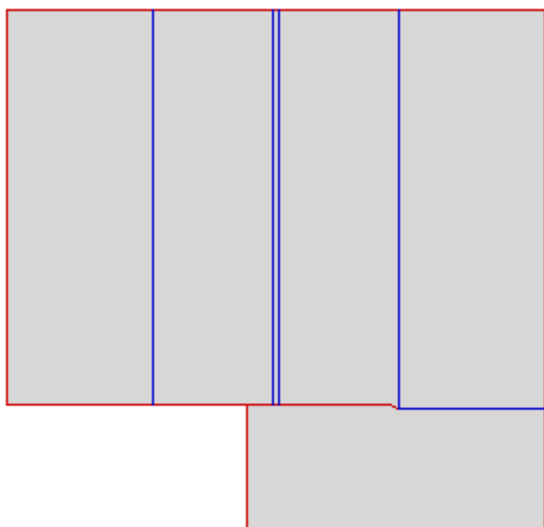

Dividers

LT190302

Glue free

Compact & E flute

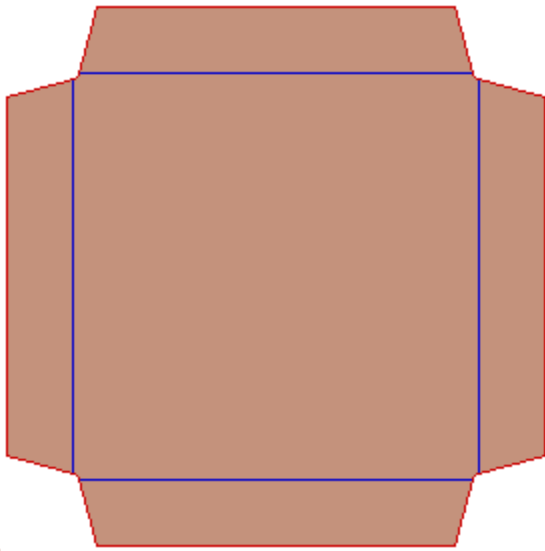

Dividers

OT190001

Glue free

Corrugated

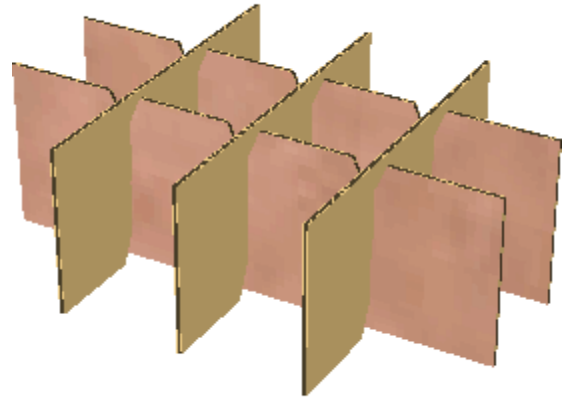
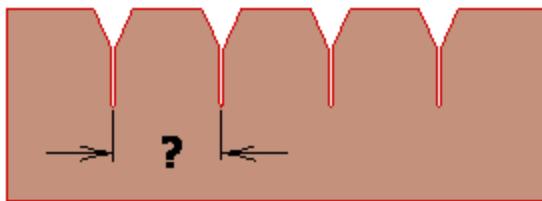
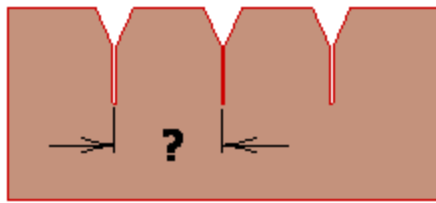

Dividers

OT190400-01

Glue free

Corrugated

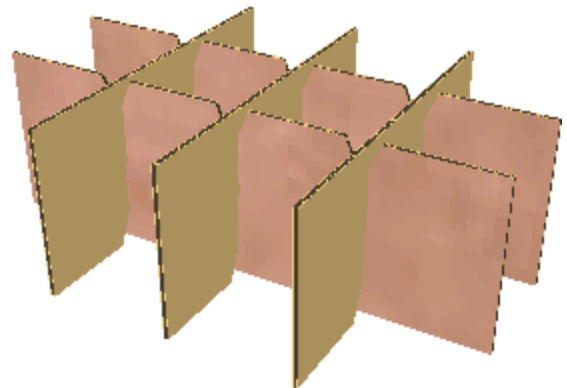
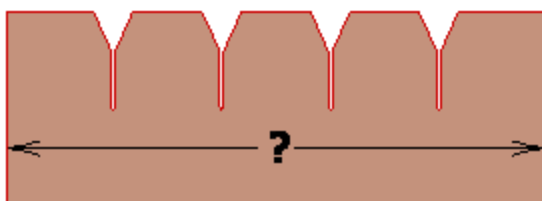
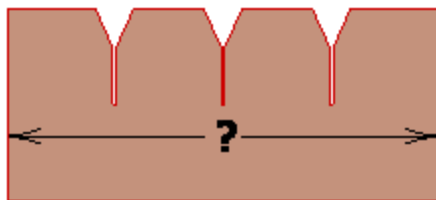

Dividers

OT190402-01

Glue free

Corrugated

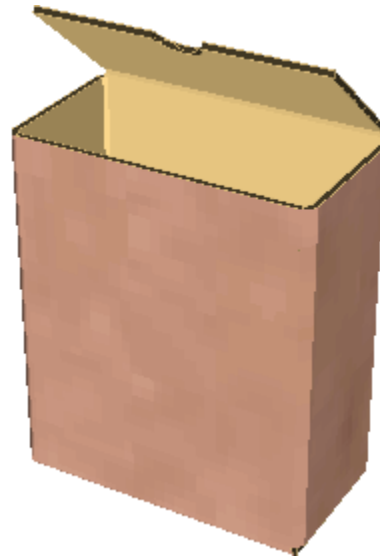
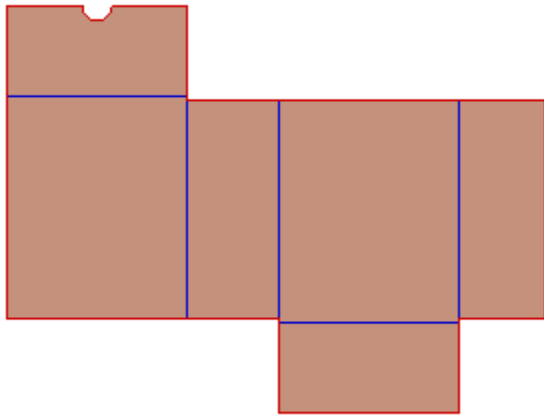

Dividers

OT190100

Glue free

Corrugated

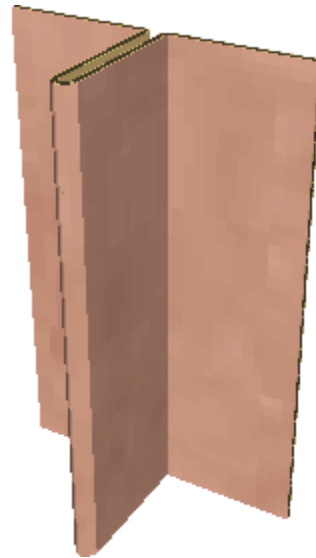
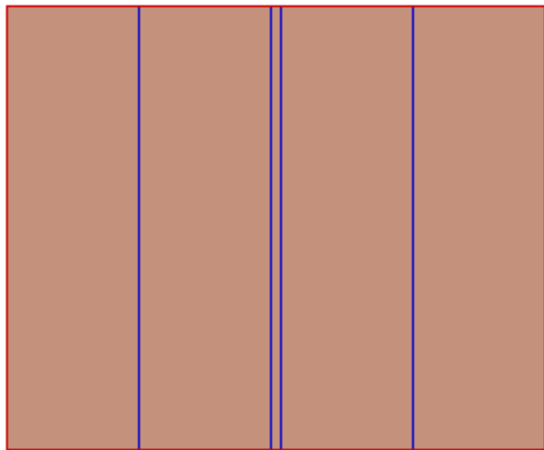

Dividers

OT190202

Glue free

Corrugated

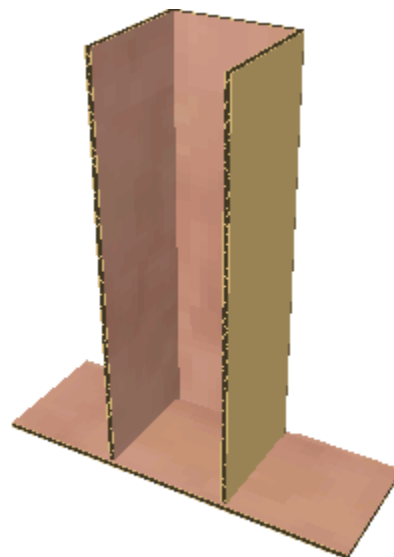
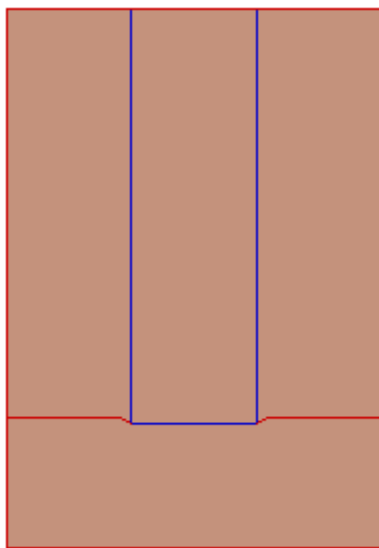

Dividers

OT190301

Glue free

Corrugated

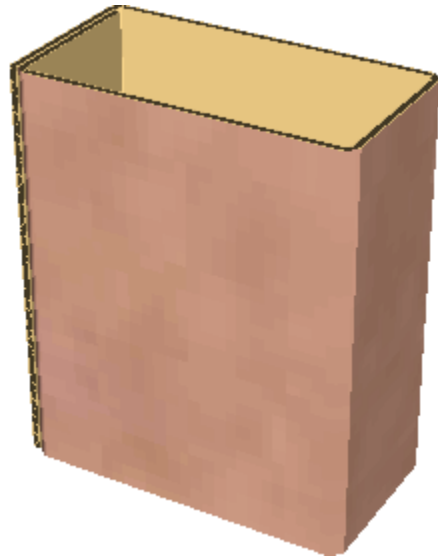
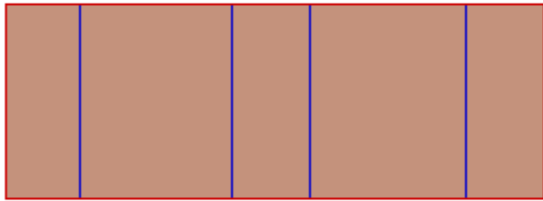

Dividers

OT190203

Glue free

Corrugated

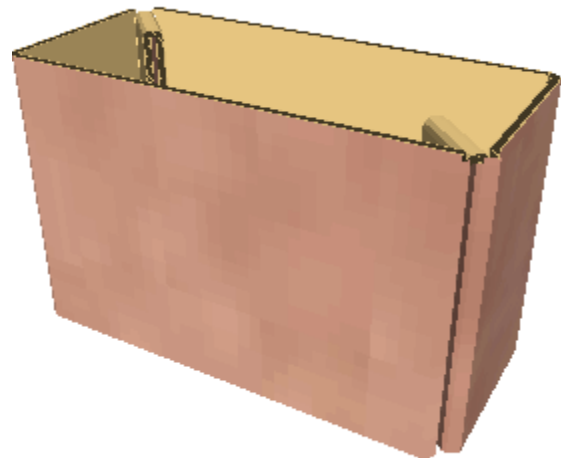
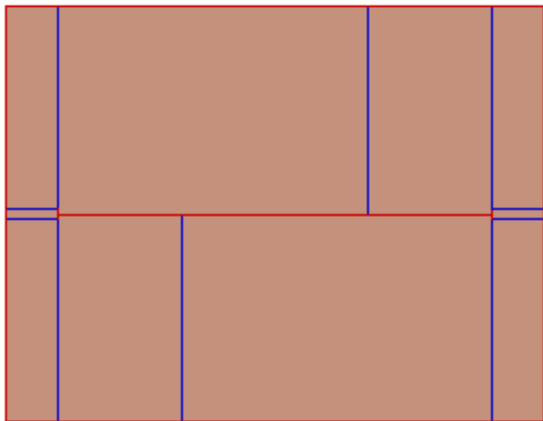

Dividers

OT190204

Glue free

Corrugated

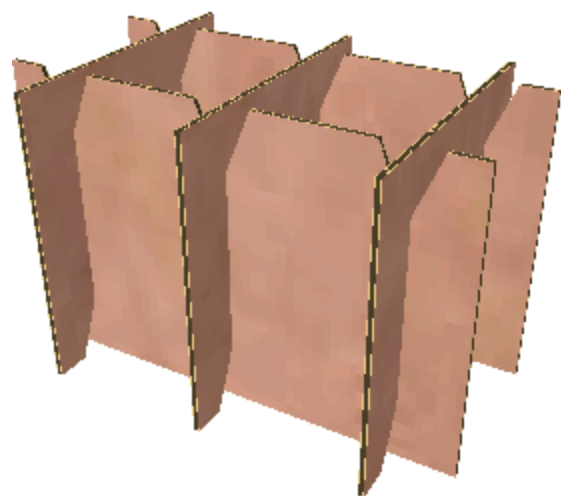
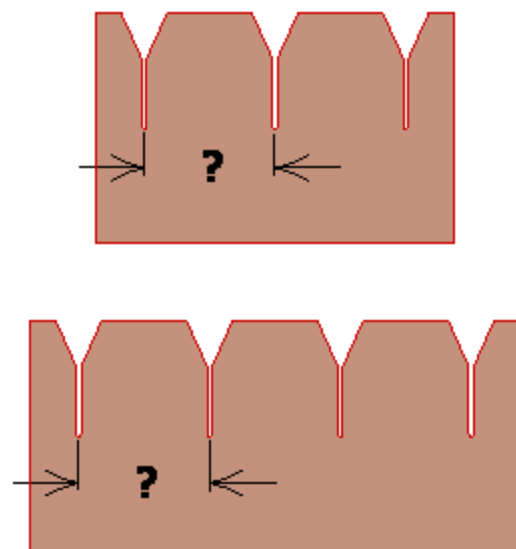

Dividers

OT190401-01

Glue free

Corrugated

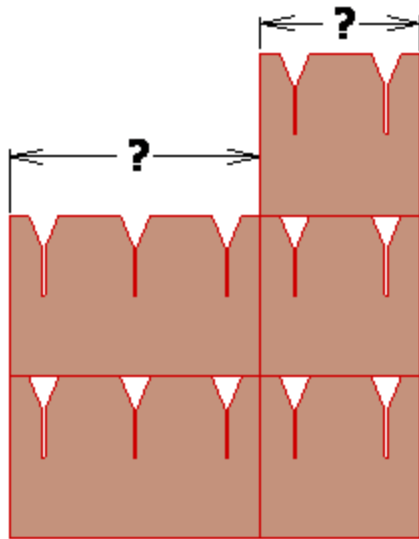

Dividers

OT190403

Glue free

Corrugated

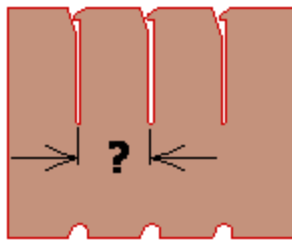
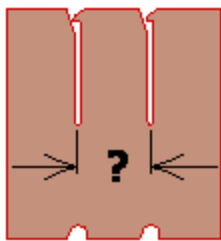

Dividers

OT190404

Glue free

Corrugated

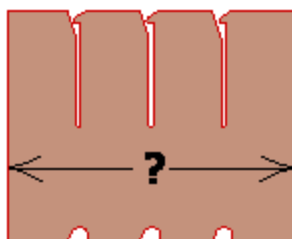
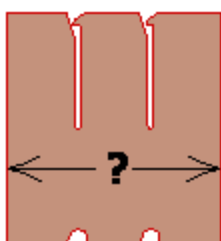

Dividers

OT190405

Glue free

Corrugated

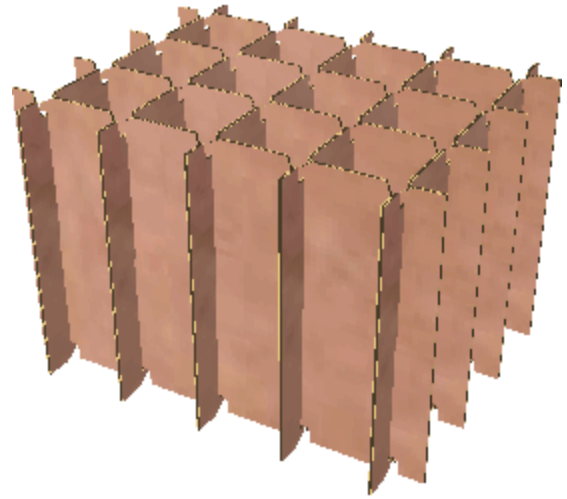
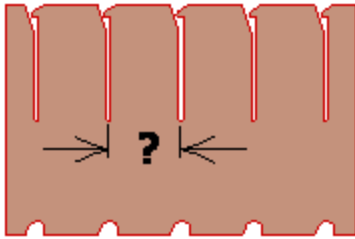
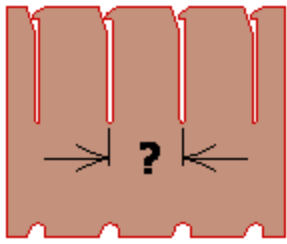

Dividers

OT190406

Glue free

Corrugated

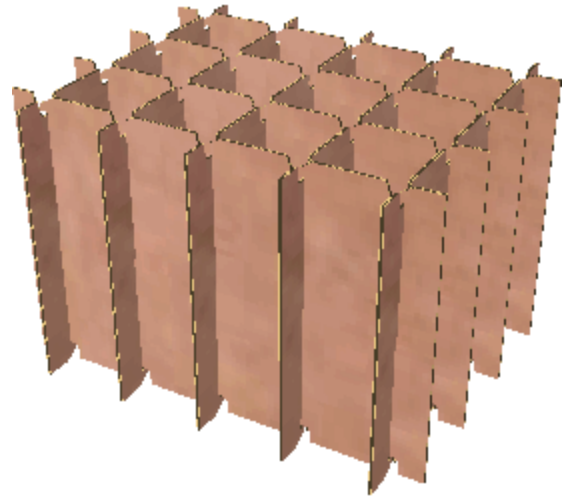
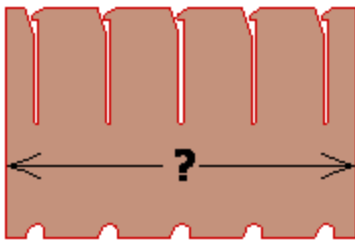
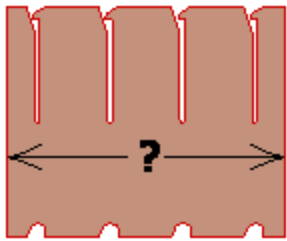

Dividers

OT190407

Glue free

Corrugated

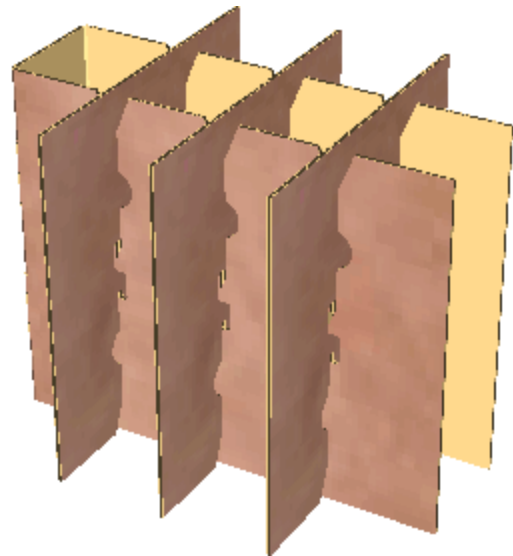
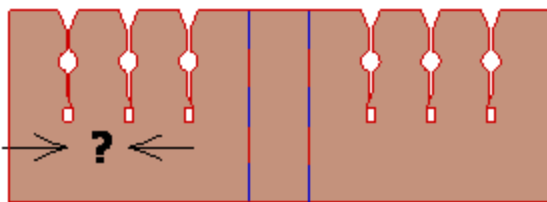
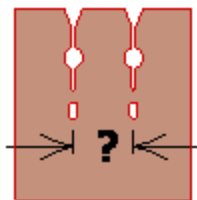

Dividers

OT190408

Glue free

Corrugated

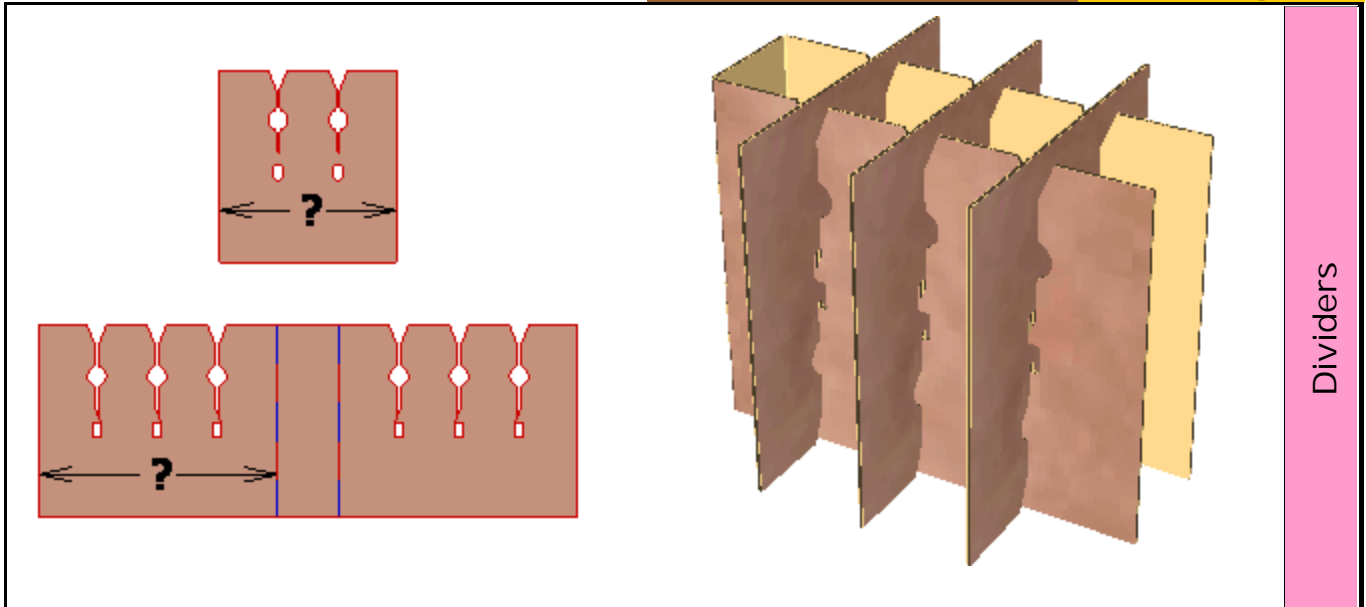

Dividers

OT190409

Glue free

Corrugated

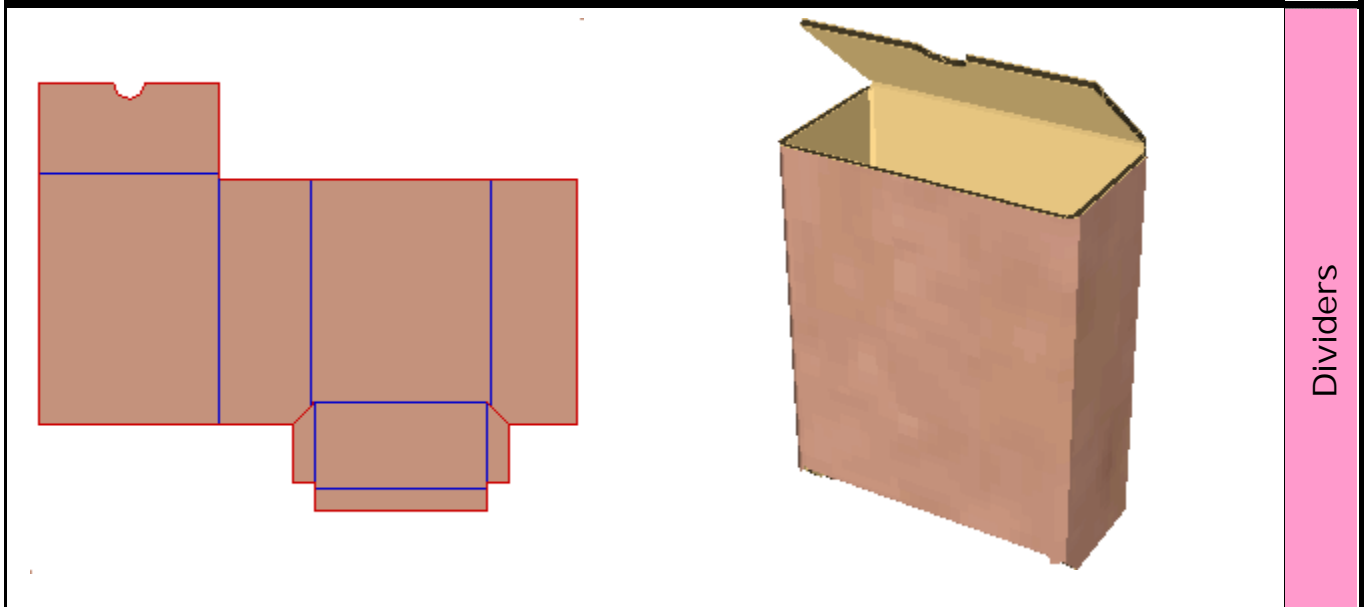

Dividers

OT190101

Glue free

Corrugated

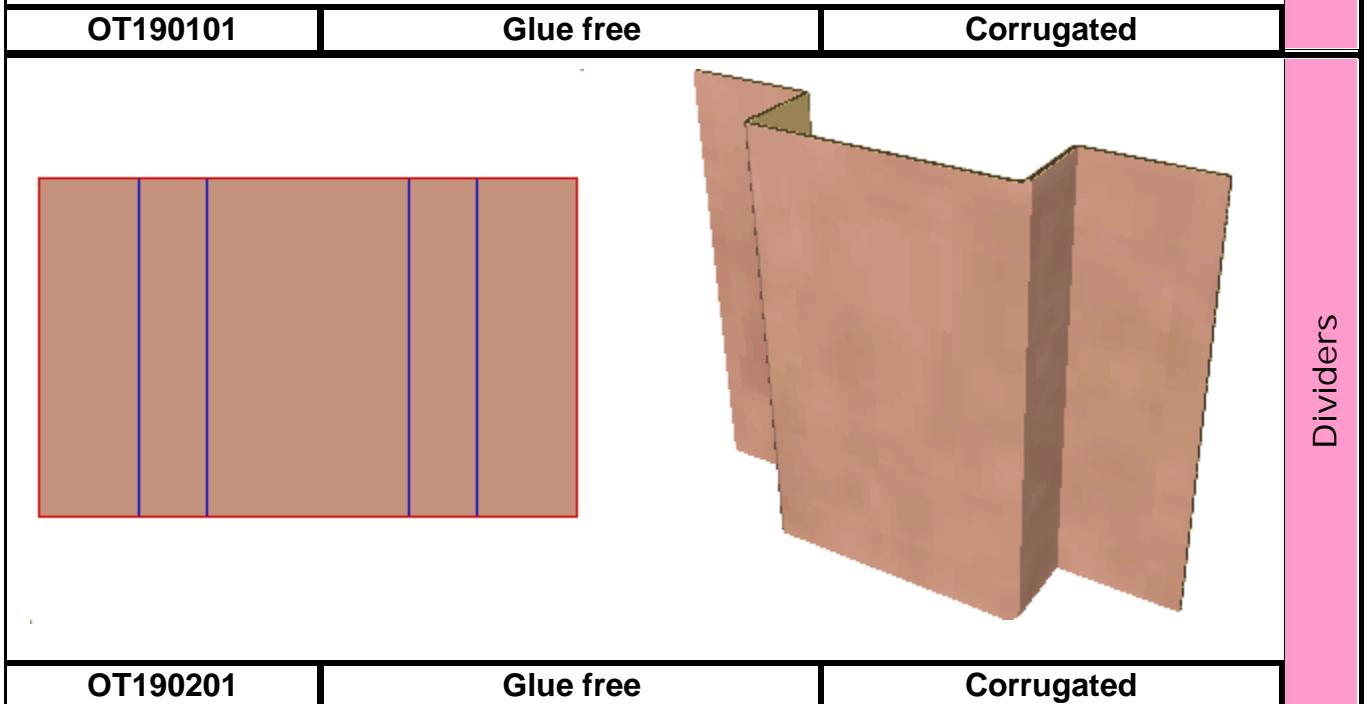

Dividers

OT190201

Glue free

Corrugated

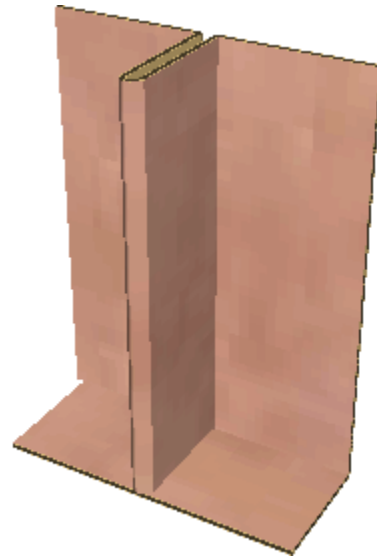
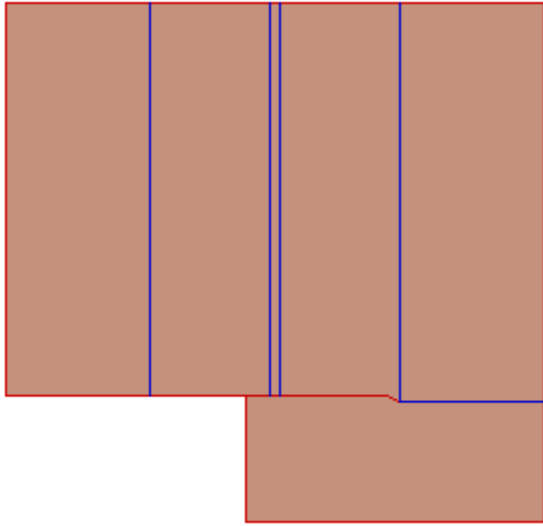

Dividers

OT190302

Glue free

Corrugated

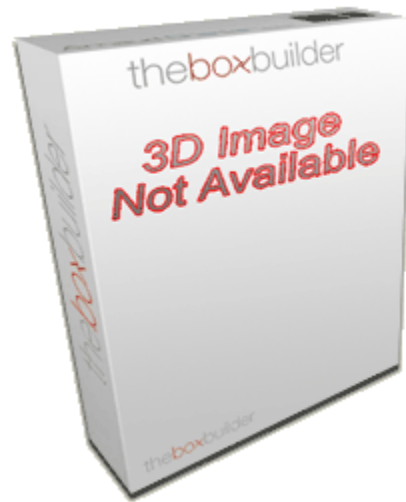
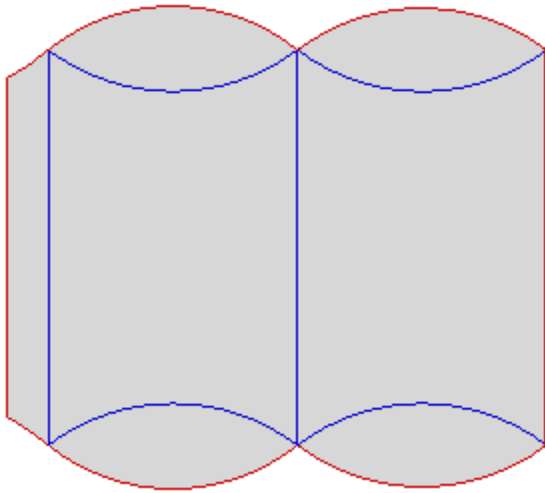

Special features

LT200001

Straight line

Compact & E flute

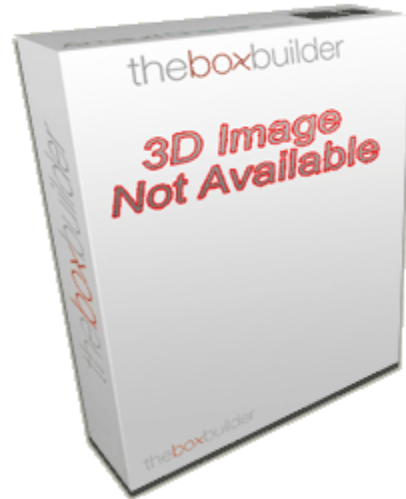
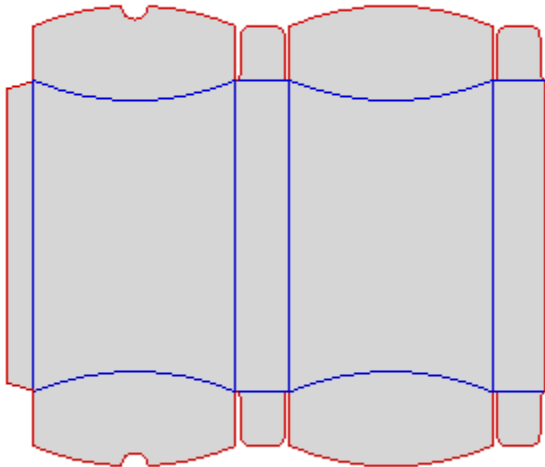

Special features

LT200002

Straight line

Compact & E flute

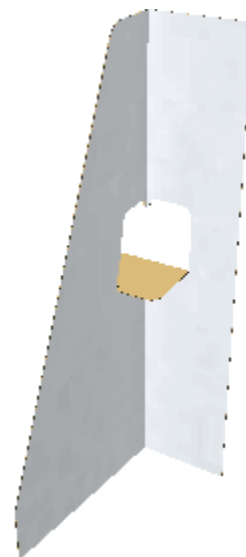
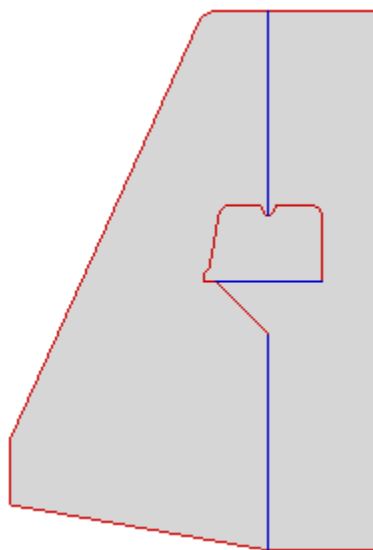

Special features

LT201001

Glue free

Compact & E flute

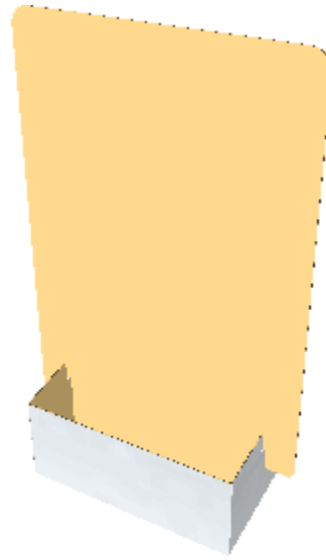
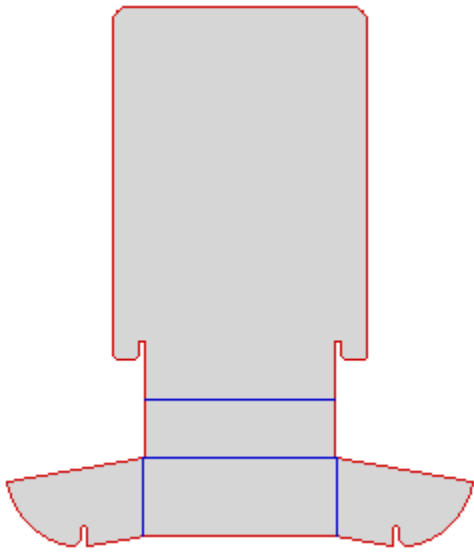

Special features

LT202001

Glue free

Compact & E flute

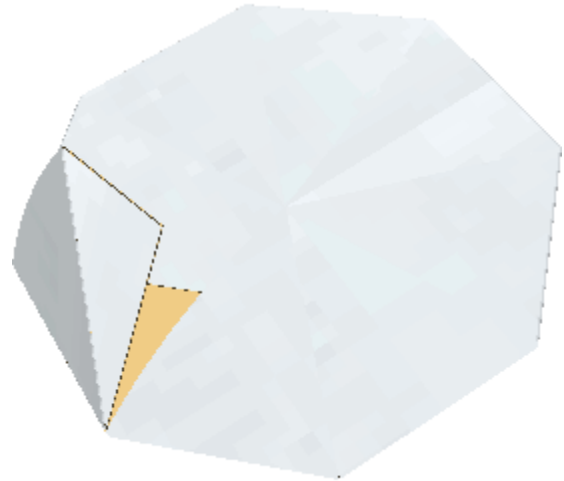
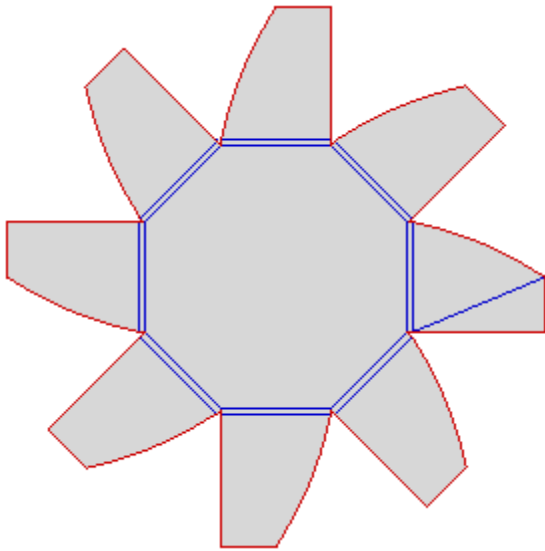

Special features

LT200105

Glue free

Compact & E flute

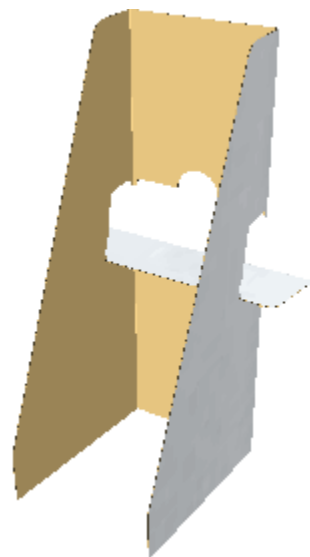
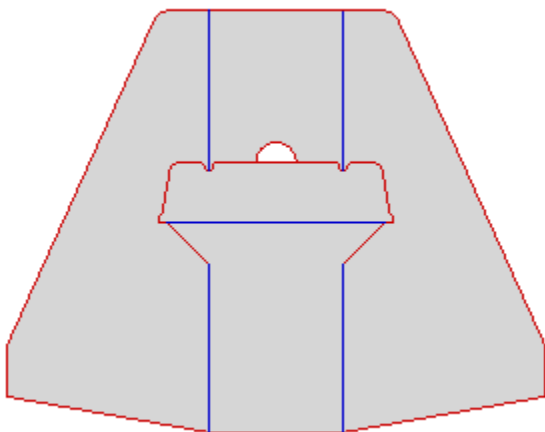

Special features

LT201002

Glue free

Compact & E flute

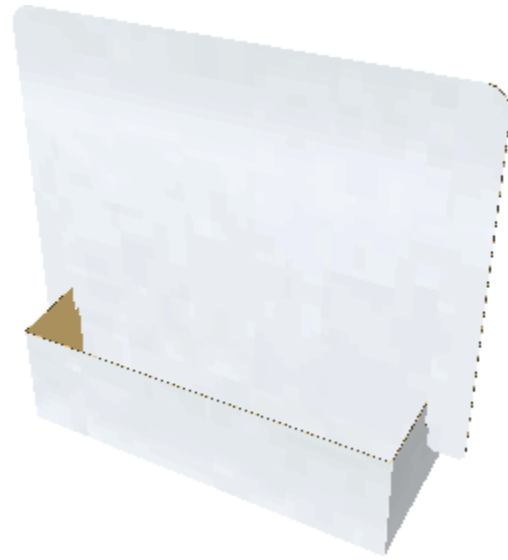
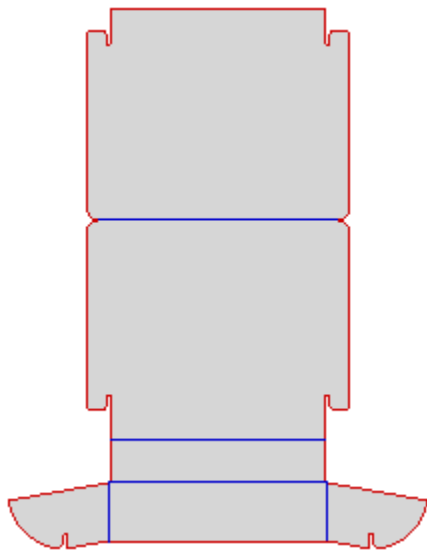

Special features

LT202002

Glue free

Compact & E flute

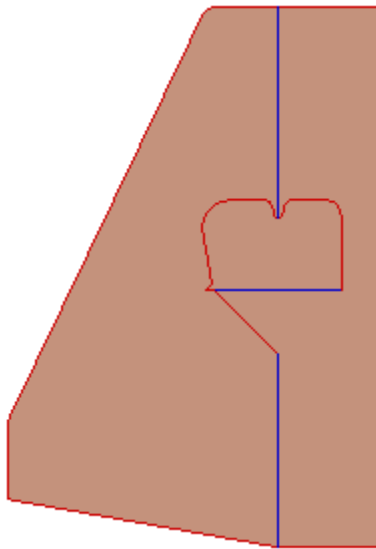

Special features

OT201001

Glue free

Corrugated

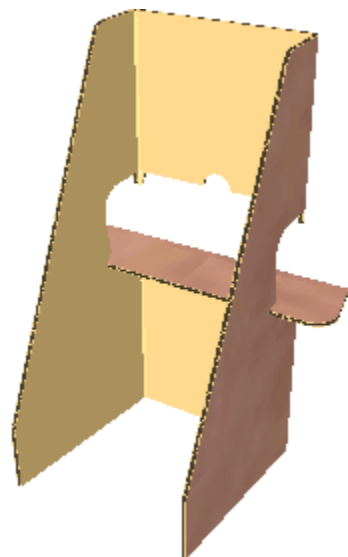
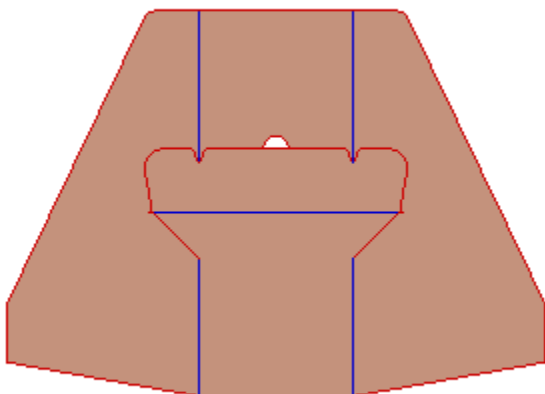

Special features

OT201002

Glue free

Corrugated